

# International Journal of Mathematics and Systems Science

— Social Systematic Science



EnPress Publisher, LLC

Add: 9650 Telstar Avenue, Unit A, Suit 121, El Monte, CA 91731

Tel: +1 (949) 299 0192

Email: [contact@enpress-publisher.com](mailto:contact@enpress-publisher.com)

Web: <https://enpress-publisher.com>

2

2024 Volume 7 Issue 2  
ISSN: 2578-1839



## Editorial Board

### Editor-in-Chief

**Prof. Maria Alessandra**  
**Ragusa**  
**Università degli Studi di**  
**Catania**  
Italy

### Editorial Board Member

**Dr. Tailei Zhang**  
Chang'an University  
China

**Dr. Muhammad Amjad**  
COMSATS University  
Islamabad, Vehari Campus  
Pakistan

**Prof. Xiaoquan Xu**  
Minnan Normal University  
China

**Prof. Nilüfer Topsakal**  
Sivas Cumhuriyet University  
Turkey

**Dr. Rosanna Campagna**  
University of Campania "Luigi  
Vanvitelli"  
Italy

**Prof. Eva A. Gallardo-  
Gutiérrez**  
Universidad Complutense de  
Madrid & ICMAT  
Spain

**Dr. Pratibhamoy Das**  
Indian Institute of Technology  
India

**Prof. Dr. Hari Mohan Srivastava**  
Department of Mathematics and  
Statistics, University of Victoria  
Canada

**Dr. Asim Kumar Das**  
Government General Degree College  
India

**Prof. Juan Ramon García Rozas**  
University of Almeria  
Spain

**Prof. Joseph David Lakey**  
New Mexico State University  
United States

**Dr. Dan Tian**  
Xi'an University of Architecture and  
Technology  
China

Volume 7 Issue 2·2024

EISSN: 2578-1839

# International Journal of Mathematics and Systems Science

**Editor-in-Chief**

**Prof. Maria Alessandra Ragusa**

*Università degli Studi di Catania,*

*Italy*



**International Journal of Mathematics and Systems Science**

<https://systems.enpress-publisher.com/index.php/IJMSS>

**Contents**

*Original Articles*

**Empowering Education with AI: Insights into Personalization, Adaptive Platforms, and the Future of Learning**

*Lei Pei, Sarah Qiao, Shiyang Gong / 1*

**A Study on the Application of Nanolearning in Business English Teaching from the Perspective of Mobile Learning**

*Ning Lv, Xue Yin / 5*

**The Death Penalty Should Not Continue To Exist:**

**Abolition And Replacement Of The Death penalty In China's Criminal Justice System**

*Yuemin Chen / 8*

**The relationship between globalization and populism: Will globalization promote populism?**

*Lufei Wu / 14*

**Balancing authority and affinity: Communication strategies in preschool teachers' home cooperation**

*Ruijun Ran / 18*

**Analysis on the role of ideological and political elements in college badminton**

*Shuaijun Hu, Mida Dai / 21*

**Research on Strategies for Developing Language Sensibility in Upper Elementary Chinese Education**

*Li Jie / 24*

**On the problems encountered in the development of non-profit organizations and optimization measures**

*Doudou Li, Wenchuan Li / 28*

**Significance, Challenge and Opportunity of Volunteer Participating in Museum Education**

*Qing Wang, Chuanyan Cao / 31*

**Application of Blockchain Technology in Emergency Supply Chains**

*Guanwei Huang, Xingying Wang / 36*

**Prediction of growth trend and application of *Synechococcus* PCC7002 in industrial culture based on MTS-Mixers**

*Sichao Hu / 39*

**What impact does Covid-19 have on the Fast Fashion Industry(H&M) and Luxury Fashion Industry (Louis Vuitton)?**

*Sixian(Milly) Miao / 45*

**The Problems and Countermeasures of Family Doctor Service in China**

*Yidi Xu / 48*

**High school chemistry teaching design based on project-based learning**

**—— Scientific understanding of iron supplement**

*Fenyong Zhao / 51*

**A study on the phenomenon of male couples' intimacy performance in short videos**

*Shuwen Chen / 58*

**A Study on the Chinese-English Translation of Domestic Movie Titles from the Perspective of Skopos Theory**

*Haiyan Zhou / 61*

**Analysis of the Application of Bamboo Weaving Technology in Furniture Design**

*Siyu Duan / 66*

**An Experimental Discussion on the Shaping of Confucian Business Spirit by The Great Learning**

*Lang Jie Jia Yang / 70*

**Four-Corner Model: A New Application of The Interpretive Theory in English-Chinese Written Translation**

*Wenyang Pang / 74*

**The Necessity and Feasibility of Implanting Professional Expansion Courses**

——Taking the Talent Cultivation of Art and Design Disciplines in Colleges as an Example

*Yani Yang / 78*

**On the Differences in Subjective Expressions in Contemporary Freehand Landscape Oil Painting**

*Lele Chu, Lingxi Zhou / 82*

**Reform of the rural land system and the exploration of the road of socialism with Chinese characteristics**

*Lan Zhang / 85*

**The role of differential equations in environmental science modeling**

*Sen Zhao, Zhuo Qi, Jing Lu / 90*

**Information Technology Impact on Corporate Governance: A Literature Review**

*Jiajia Deng, Xinliang Ma / 94*

**Subtitle Translation of Coco from the Perspective of Communicative Translation Theory**

*Quanju Qiu, Mengru Xu / 97*

**Couple Strength and Gentleness: Female Portrayal in Marriage and love Zajus of the Qing Dynasty**

*Beijie Ding / 102*

**Research on the Energy-Saving Design Idea of Mechanical Design and Manufacturing and Its Automation**

*Jinlong He / 105*

**Thinking and practice on the teaching reform of “sensor technology” course from the perspective of ideological and political education**

*Jun Chen, Hongbing Meng \*, Andi Yang, Jianming Xu / 108*

**The Impact of Residential Mobility on Altruistic Behavior**

*Weijian Fu / 111*

**From the Perspective of Rural Revitalization,the Existing Building Reconstruction Ideas of Rural Regional Culture are Applied**

---- take The Former Site of Liangxi Primary School in Wangcun as an Example

*Yitong Wang / 117*

**Research on the Supply of Public Cultural Services in Bayanhot Town**

*Yakun Wang, Cuiying Yu / 122*

**Duolun County Resource and Environmental Carrying Capacity Study**

*Su Ri Ge Ri Le Tu, A Ru Han / 125*

**Teaching reform and exploration of Game Programming Design to cultivate Computational thinking**

*Hao Liu / 132*

**The Enlightenment of Western Education Leadership Theory to Higher Education Management in China**

*Shanghong Sun / 135*

**Exploration on the construction of teaching Leadership in the Era of Big Data**

*Yong Yang / 138*

**Strategic Research on International Communication of Chinese Traditional Sports Culture under the Background of “the Belt and Road”**

*Sijia Jiang / 141*

**Innovative practice of RMP training mode under multi-level course objectives**

*Fang Li, Xiaofang Guo, Rong Liu / 144*

**It briefly describes the philosophical thoughts on human nature, sin and redemption in the Divine Comedy**

*Anbo Yang, Linshan Bao, Mingbo Xia, Haijia Zuo, Jiachen Ma, Jiayi Wang / 147*

**Application research of guided inquiry teaching mode in the teaching of Introduction to Educational Studies**

*Qiongxiang Xiang, Ruixiang Lv / 152*

**A Study on the Application of Group Cooperative Learning Model in the Teaching of Introduction to Education**

*Qiongxiang Xiang, Ling Xiao / 155*

**Discourse Analysis in Junior High English Material Adaptation: Holistic Unit Teaching and Activity-Based Approaches in China**

*Chunyi Chai / 158*

**A study on cross-cultural adaptation of Indian students in Changsha**

*Yuyan Qiu / 162*

**Research on the Project Management of Innovation and Entrepreneurship Training Program for College Students**

*Pingan Gao / 165*

**On the Strategies of Student Management under the Guidance of High Quality Talent Training in Universities**

*Huiming Li / 168*



**Through analysis of historical data to reappear the last moment of Zhiyuan**

*Ziming Pan / 171*

**A Study on Digital Literacy of College English Teachers in Digital Age**

*Hui Guan, Wenping Li / 174*

**The Ideological and Political Construction of Financial Management Courses Based on the FT Course Construction Model**

*Jun Yin / 177*

**Exploration of Data Science Construction in Big Data Environment**

*Tianshu Shi / 180*

**Responding to “the Asking of Qian Xuesen “-Survey and Exploration on Cultivation of Outstanding Talents in China**

*Xiaofang Guo, Rong Liu, Xiao Wang / 183*

**Research on the Path of Cultivating Self-education Ability of College Students in the Perspective of Internet**

*Xuan Weng / 186*

**Research on Preventing College Students from Overusing Network Technology for Learning under the Background of Technological Criticism Philosophy**

*Yingying Wu, Yibo Song / 190*

**Integrating popular and electronic music: strategies and practices to stimulate students' interest in modern music education**

*Chenlei Sun / 195*

**Reflections on Higher Chemistry Education**

——Study based on the aspartame carcinogenicity controversy

*Song Deng, Xiaochun Wu / 198*

# Empowering Education with AI: Insights into Personalization, Adaptive Platforms, and the Future of Learning

Lei Pei, Sarah Qiao, Shiyan Gong

University of The Auckland, Auckland 1010, New Zealand.

---

**Abstract:** In the era of Industry 4.0, AI has emerged as a transformative force in the educational landscape. This literature review investigates the profound impact of AI on modern education, with a primary focus on its role in personalized learning, adaptive education, and the advent of virtual teacher assistants like ChatGPT. Through extensive analysis, we identify that AI systems, by leveraging data, offer personalized feedback and guidance, thus optimizing the learning experience. While AI holds promising potential for revolutionizing education, it also presents challenges such as ethical considerations of data privacy and the dynamic nature of its technologies. Furthermore, AI's global influence promises to reshape traditional teaching methods, emphasizing a more individualized approach, and potentially democratizing high-quality educational access across the globe.

**Keywords:** AI; Personalized Learning; ChatGPT; Ethical Considerations

---

## 1. Introduction

In the context of Industry 4.0, the importance of intelligent manufacturing has been recognized, and the convenience and high efficiency it brings have propelled the advancement of various technologies, such as machine learning, big data, cloud computing, AI, and other emerging technologies (Strich et al., 2021). AI is the intelligence exhibited by machines that contrasts with the natural intelligence exhibited by humans. The development of AI as a discipline began in 1956 with the aim of enabling computers to perform tasks that typically require human intelligence. The goal of AI is to equip computer systems with capabilities related to human intelligence, such as understanding, learning, adapting, and performing functions like solving computational problems, processing multiple languages, recognizing images and text, and making autonomous decisions without human intervention (Asatiani et al., 2021). The field of AI draws from computer science, mathematics, psychology, linguistics, philosophy, and many other domains (Li et al., 2021). In recent years, the development of AI has progressed rapidly, making significant strides and advancements across multiple industries and domains, encompassing fields such as healthcare, finance, big data analysis, computer science, education, and various other domains.

The development of AI in the education sector has made significant strides over the past three decades. The research and development of various new technologies stem from the extensive learning of vast amounts of data. The emergence of high-performance products has provided an excellent interactive learning environment, capable of improving learning efficiency in a remarkably short time (Van den Broek et al. 2021). For instance, the evolution of personalized learning and adaptive education enables AI to offer learning content and resources tailored to each student's learning style, interests, and abilities. This personalized approach to teaching contributes to enhanced student learning outcomes.

Another prevalent AI tool is the virtual teacher assistant, employing dialogue system technology to answer students' questions, explain concepts, or provide learning advice based on individual student profiles. These assistants are available to support students at any time, alleviating the burden on teachers. Moreover, one of the most noteworthy AI support tools in recent years is none other than ChatGPT. In November 2022, OpenAI launched the AI-powered chatbot, ChatGPT, which has witnessed a rapid global user adoption, surpassing 100 million users in just a few months (Nah et al., 2023). Naturally, this technology has sparked extensive discussions about its potential impacts on the higher education industry.

To delve into the potential long-term and short-term effects of these emerging technological developments on the education sector, this literature review discusses several instances of AI applications in education. It examines the positive and negative impacts they bring and proposes the possibilities of AI's future development in the education sector, along with potential research avenues to advance these possibil-

ities.

## **2. AI's role in the rise of personalized learning and adaptive education**

### **2.1 Personalized Learning Through AI**

AI's data processing capabilities have transformed education, allowing platforms to tailor content to individual needs. Studies like those by Liao et al. (2023) and Leung et al. (2023) demonstrate AI's effectiveness in identifying student challenges and customizing learning experiences. Tools like Khan Academy use AI for real-time feedback, aiding self-assessment and addressing learning gaps.

### **2.2 AI-Enhanced Education in the COVID-19 Era**

The pandemic has shifted education towards AI-driven, responsive methods. AI has been instrumental in moving away from one-size-fits-all models to customized learning paths, as shown in research by Jahnke et al. (2022) and Leung et al. (2023). AI-powered digital simulations offer interactive learning, adapting to student comprehension in real-time.

### **2.3 Ethical and Human Considerations in AI Education**

With AI's integration in education, ethical challenges, particularly data privacy and surveillance, arise. Dehling & Sunyaev (2023) and Bozkurt et al. (2021) highlight the need for transparent data use and caution against over-reliance on AI, which may affect human creativity and knowledge.

### **2.4 Future Landscape of AI in Education**

Future educational methods, as suggested by Jahnke et al. (2022), could involve Artifact-Generated Learning (AGL) and online communities for collaborative learning. AI's potential in special education is notable, with developments like eye-tracking methods for cognitive assessment and adaptive platforms for students with learning disabilities, as discussed by Alashoor et al. (2022). AI is set to significantly reshape learning experiences and methodologies.

## **3. Analysis of Virtual Teacher Assistants and AI Chatbots in Education**

### **3.1 Enhancing Learning with Virtual Teacher Assistants**

AI chatbots like ChatGPT are redefining student engagement in education. These tools, through advanced natural language processing, offer personalized feedback and learning pathways, addressing traditional classroom limitations. Song, Xu, & Zhao (2022) emphasize their role in personalizing education, reflecting a shift towards more individualized learning experiences.

### **3.2 Benefits from the Educators' Perspective**

Educators are recognizing the value of integrating virtual teacher assistants to enhance teaching methodologies and personalize student learning. These AI tools aid in understanding student learning patterns, thus improving teaching efficiency and creativity (Seeber, et al., 2020). They are particularly useful in large classes or where direct student-teacher interaction is limited.

### **3.3 Challenges in Integrating Virtual Teacher Assistants**

Adopting virtual teacher assistants involves challenges like keeping up with AI advancements and rethinking traditional teaching models. Ethical concerns, such as data privacy and biases, also need attention. Petrović & Jovan (2021) note that effective integration of these tools requires significant effort and refinement.

### **3.4 Global Impact and Future Prospects**

AI chatbots like ChatGPT have the potential to globally transform education by facilitating access to quality resources and promoting individualized learning. The future of education may see an increased reliance on AI to complement traditional teaching, leading to more

dynamic and interactive global classrooms. Research by Turja, et al. (2020) indicates that the usage and effectiveness of these tools can be predicted by factors like perceived usefulness and social influence, pointing to their growing role in educational settings.

## 4. Conclusion

AI is significantly transforming education, turning the concept of personalized learning into a practical reality and enhancing student engagement through tools like ChatGPT. This evolution, while innovative, presents challenges, as noted by Fügener et al. (2021), emphasizing the need for a balance between AI and human elements in education. The future of education, increasingly AI-driven, points towards a more dynamic and individualized learning environment. It's crucial, however, to address the challenges of this transformation, ensuring that the advancement in educational methods remains ethical and human-centric.

## References

- [1] Alashoor, T., Keil, M., Smith, H. J., & McConnell, A. R. (2022). Too Tired and in Too Good of a Mood to Worry about Privacy: Explaining the Privacy Paradox through the Lens of Effort Level in Information Processing. *Information Systems Research*. Retrieved from <https://www.researchgate.net/publication/364758936>.
- [2] Asatiani, A., Malo, P., Rådberg Nagbøl, P. R., Penttinen, E., RintaKahila, T., & Salovaara, A. (2021). Sociotechnical Envelopment of AI: An Approach to Organizational Deployment of Inscrutable AI Systems. *Journal of the Association for Information Systems*, 22(2), 325–352. <https://doi.org/10.17705/1jais.00491>.
- [3] Bozkurt, A., Karadeniz, A., Baneres, D., Guerrero-Roldán, A. E., & Rodríguez, M. E. (2021). AI and Reflections from Educational Landscape: A Review of AI Studies in Half a Century. *Sustainability*, 13(800).
- [4] Dehling, T., & Sunyaev, A. (2023). A Design Theory for Transparency of Information Privacy Practices. *Information Systems Research*. Institute for Operations Research and the Management Sciences (INFORMS). <https://doi.org/10.1287/isre.2019.0239>.
- [5] Fügener, A., Grahl, J., Gupta, A., & Ketter, W. (2021). Will Humans-in-the-Loop Become Borgs? Merits and Pitfalls of Working with AI. *MIS Quarterly*, 45(3), 1527-1556. <https://doi.org/10.25300/MISQ/2021/16553>.
- [6] Jahnke, I., Meinke-Kroll, M., Todd, M., & Nolte, A. (2022). Exploring Artifact-Generated Learning with Digital Technologies: Advancing Active Learning with Co-design in Higher Education Across Disciplines. *Technology, Knowledge and Learning*, 27, 335-364. <https://doi.org/10.1007/s10758-020-09473-3>.
- [7] Leung, A. C. M., Santhanam, R., Kwok, R. C.-W., & Yue, W. T. (2023). Could Gamification Designs Enhance Online Learning Through Personalization? Lessons from a Field Experiment. *Information Systems Research*, 34(1), 27-49. <https://doi.org/10.1287/isre.2022.1123>.
- [8] Liao, G.-Y., Huang, T.-L., Dennis, A. R., & Teng, C.-I. (2023). The Influence of Media Capabilities on Knowledge Contribution in Online Communities. *Information Systems Research*. <https://doi.org/10.1287/isre.2023.1225>.
- [9] Li, J., Li, M., Wang, X., & Thatcher, J.B. (2021). Strategic directions for AI: The role of CIOs and boards of directors. *MIS Quarterly*, 45(3), 1603–1643.
- [10] Lou, B., & Wu, L. (2021). AI on drugs: Can AI accelerate drug development? Evidence from a large-scale examination of bio-pharma firms. *MIS Quarterly*, 45(3), 1451–1482.
- [11] Nah, F.-F.-H., Zheng, R., Cai, J., Siau, K., & Chen, L. (2023). Generative AI and ChatGPT: applications, challenges, and AI-human collaboration. *Journal of Information Technology. Case Appl. Res.*, 25(3).
- [12] Petrović, J., & Jovanović, M. (2021). The Role of Chatbots in Foreign Language Learning: The Present Situation and the Future Outlook. In *AI: Theory and Applications* (pp.313–330). Springer, Cham.
- [13] Seeber, I., Bittner, E., Briggs, R. O., de Vreede, T., de Vreede, G. J., Elkins, A., Maier, R., Merz, A. B., Oeste-Reiß, S., Randrup, N., Schwabe, G., & Söllner, M. (2020). Machines as teammates: A research agenda on AI in team collaboration. *Information and Management*, 57(2). <https://doi.org/10.1016/j.im.2019.103174>.
- [14] Song, X., Xu, B., & Zhao, Z. (2022). Can people experience romantic love for AI? An empirical study of intelligent assistants. In-

formation and Management, 59(2). <https://doi.org/10.1016/j.im.2022.103595>.

[15] Strich, F., Mayer, A.-S., & Fiedler, M. (2021). What do I do in a world of AI? Investigating the impact of substitutive decision-making AI systems on employees' professional role identity. *Journal of the Association for Information Systems*, 22(2), 9.

[16] Susarla, A., Gopal, R., Thatcher, J. B., & Sarker, S. (2023). The Janus Effect of Generative AI: Charting the Path for Responsible Conduct of Scholarly Activities in Information Systems. *Information Systems Research*, 34(2), 399-408. <https://doi.org/10.1287/isre.2023.ed.v34.n2>.

[17] Turja, T., Aaltonen, I., Taipale, S., & Oksanen, A. (2020). Robot acceptance model for care (RAM-care): A principled approach to the intention to use care robots. *Information & Management*, 57, 103220. <https://doi.org/10.1016/j.im.2019.103220>.

[18] Van den Broek, E., Sergeeva, A., & Huysman, M. (2021). When the machine meets the expert: An ethnography of developing AI for hiring. *MIS Quarterly*, 45(3), 1557-1.

# A Study on the Application of Nanolearning in Business English Teaching from the Perspective of Mobile Learning

Ning Lv, Xue Yin

QingDao City University, Qingdao 266106, China.

---

**Abstract:** With the rapid development of information technology, new mobile terminals are gradually applied to mobile micro-learning. According to the horizon report issued by NMC, mobile technology has been listed as an important technology with developmental potential and applicable space in the field of education in recent years, which will have a positive impact on both teaching and learning. As an important English for special purpose, business English has the characteristics of professionalism and practicality. It covers a wide range of learning resources and strong effectiveness, which is to a great extent different from traditional English learning. Considering the features of business English and the current situation of business English teaching, this paper discusses the advantages of mobile learning to business English teaching and talks about the popular nanolearning model with the purpose of providing new ideas for optimizing business English teaching.

**Keywords:** Mobile Learning; Nanolearning; Business English

---

## 1. Introduction

Under the background of economic globalization and “One Belt and One Road”, the reform of business English teaching should keep pace with the times, whose goal is to train comprehensive international talents who are not only equipped with business knowledge, but also the abilities to conduct business activities. In 2016, the Ministry of Education proposed in the 13th five-year plan of Educational Informatization that the concept of “E-learning space” should be transferred from “serving classroom learning” to “supporting networked ubiquitous learning”, continuing to encourage the in-depth and extensive application of information technology in daily teaching.<sup>[1]</sup> In recent years, with the rapid development of mobile technology and the continuous optimization of internet environment, the mobile micro-learning, which is based on mobile technology and utilizes micro-media to present information resources and maximize people’s fragmented learning time, arises at this historic moment. Therefore, how to give full play to the strengths of mobile learning, introduce mobile learning into the teaching and skills training system, and further deepen the teaching reform of business English majors in higher vocational colleges has become an urgent problem to be studied and solved.

## 2. The Application of Mobile Learning in Language Learning

The research on mobile learning can be traced back to a study called the Wireless Andrew project conducted by Carnegie Mellon University in 1994. In 2003, Alexander Dye proposed that “Mobile learning is a kind of learning that can be carried out at any time and anywhere with the help of mobile devices. Mobile devices used in mobile learning must effectively present learning content and provide two-way communication between teachers and learners.”<sup>[2]</sup> Compared with foreign countries, the research on mobile English learning in China starts relatively late. Since the beginning of the 21st century, the research and exploration of mobile learning mainly involves the exploration of mobile learning theory, the research of mobile learning carrier and the design and development of mobile learning resources and courses.

The researchers roughly define mobile learning from two perspectives, namely, the technical perspective and the learner’s perspective. Researchers who define mobile learning from a technical perspective believe that mobile language learning is undertaken by the use of portable mobile devices, including mobile phones, tablet computers, electronic dictionaries and so on. While from the learner’s point of view, mobile learning is any kind of learning that occurs in a place where the learner doesn’t study in a fixed or predetermined place, or where the learner makes use of the learning opportunities provided by mobile technology.

Mobile learning has the characteristics of mobility, infinity, strong personalization, autonomy as well as flexibility and strong interaction.<sup>[3]</sup> Compared with traditional learning, it has positive implications for business English majors and students in higher vocational colleges.

The flexibility of its learning environment makes the learning of applied foreign language majors break through the limitations of time and space. In addition, its social interaction and situational sensitivity also help to promote student-centered learning style and personalized learning process, and makes learners' learning motivation attract more attention.<sup>[4]</sup>

### **3. Nanolearning**

Different from other types of web-based distance learning, mobile learning can use mobile terminals to spread segmented knowledge content with short, prominent theme and strong practicability, and meet the needs of people to carry out informal learning anywhere. Especially under 5G technology, it is characterized by the clarity of learning needs, the fragmentation of learning content, the liberalization of learning environment, the mobility of learning style and the lifetime of learning time limit.<sup>[5]</sup> Nanolearning is an significant teaching method in the field of education and training after the epidemic. The earliest foreign article that can be traced back to nanolearning is the nano-learning-miniaturization of design published in 2006. Subsequent papers tend to compare nanolearning with microclasses, but there are few articles that study nanolearning alone. After 2020, nanolearning has gradually developed on a small scale in China. The time limit of each video is shorter than that of micro-classes, which lasts about 2 to 3 minutes. It is not an exposition of some part of the knowledge of the classroom, but a further expansion for specific topics. This model builds a mobile learning environment for learners, which integrates interactive experience and resource. Students can carry out collaborative learning and further deepen the ability to use knowledge appropriately.

### **4. The Current Situation of Business English Teaching**

Business English, as "English for special purpose", refers to English related to a particular profession or discipline, such as English for science and technology, legal English, and so on. Nowadays, business English teaching in colleges and universities can be divided into two modes: English teachers or professional teachers. However, both professional teachers and English teachers are lack of working experience in enterprises, and what they teach in class is still only some theoretical knowledge. Specifically, the main problems are:

#### **4.1 Single teaching mode**

3P model, namely presentation, practice and production, is the mainstream teaching mode in business English classroom at present. This model is a typical teacher-centered model. Teachers are the masters, decision-makers and main executors of the classroom, while students play the role of passive listeners in the classroom, which affects students' interest and desire for learning. However, with the help of mobile Internet, learners can learn anytime and anywhere, come into contact with rich learning resources, and break the traditional learning thinking.

#### **4.2 Little teaching interaction**

The practical teaching process in business English classroom is weak, and there are few teaching design about interactive communication and situational task. Although many teachers will ask questions in class, the questions are generally simple vocabulary and sentence translation, which is far from forming an interactive learning situation in which teachers and students cooperate with each other. There is no doubt that it is not in line with the learning-centered teaching concept. On the other hand, the mobile learning model can free teachers and learners in some ways. Learners can learn relevant content independently, while teachers can interact with students offline to answer questions and carry out case experience. Teachers are supposed to create different situational themes for learners, guide and organize students to experience real business situations in groups, and deeply improve business skills and strategies from cases.

#### **4.3 Uncertain learning resources**

Learning based on mobile terminals mainly depends on a variety of online learning resources, while all kinds of learning Apps have different functions and purposes. As a result, students sometimes combine several of them, so it is difficult to plan their learning reasonably. Therefore, it is necessary for teachers to optimize the curriculum, integrate relevant important and difficult knowledge for different topics, and assist in collocation with nanolearning model, using superstar platform, etc., to plan the content so as to help students master professional knowledge and relevant skills.

## **5. Strategies for Business English Teaching Reform under Mobile Learning Mode**

### **5.1 Utilization of mobile learning to create a good learning atmosphere**

The main purpose of business English courses is to train students to have solid English skills on the one hand and basic theories and knowledge of management, finance, law and other related disciplines on the other. Students will be qualified to have a broad international vision, high humanistic literacy and cross-cultural communication skills as well as rich international business knowledge so that students can use fluent English in business, foreign affairs, management and other fields. Therefore, business English teaching should integrate the training of language skills, the accumulation of business knowledge and the cultivation of business practical ability. Besides, mobile learning can provide students with corresponding learning resources according to their environment, so that they can be in a realistic English environment all the time. Teachers can also participate in the design of the mobile terminal App, simulate the real language environment, and integrate efficient learning plans into mobile learning resources. Students will be given more opportunities to get in touch with English, spark their interests in learning, and improve their ability to use business English in practical work.

### **5.2 Utilization of mobile learning to change English teaching concept and enrich teaching content**

Mobile learning focuses on students' individual needs in learning, emphasizing that teachers should encourage students to learn rather than simply instilling knowledge and skills into students. Teachers are no longer the leaders of the classroom, but motivators and guides, offering auxiliary guidance to stimulate students' enthusiasm for autonomous learning and tap students' interest in learning. Nanolearning not only has the characteristics of digitalization, multimedia, networking and intelligence, but also has its unique advantages. It can help students learn short videos quickly anywhere and anytime. Teachers should take into account the pros of fragmentation of mobile learning, split complex knowledge points into materials suitable for fragmented learning, and help students expand the breadth and depth of knowledge.

### **5.3 Utilization of mobile learning to improve the teaching evaluation system, curriculum design and the profession of teachers**

In business English teaching, we can change the evaluation system with examination results as the main evaluation means, and carry out dynamic and continuous formative evaluation reports on students through the background data collected by the mobile learning platform, evaluating students' learning effect more objectively and fairly. Teachers can also rely on mobile learning resources such as mobile App, online learning resource database and online discussion area, combined with nanolearning model, to solve the key and difficult points of basic and professional courses of business English. Students are guided to dig deep into topics, finally expanding the scope and depth of learning. In order to improve teachers' teaching and research level, teachers should concentrate on the improvement of their own professional ability in order to better promote and boost the teaching reform of business English majors.

Generally speaking, mobile learning is both an opportunity and a challenge for business English teaching. The combination of mobile learning and traditional teaching mode can effectively promote the reform and development of business English teaching, and give a great impetus to education for all, life-long education and personalized learning.

## **References**

- [1] Zhou Wenxin, Duan Hongying. The Practice and Enlightenment of SPOC in Business English Flipping Teaching Based on Mobile Learning. *Journal of Zhejiang Institute of Water Conservancy and Hydropower*, 2018. 09.
- [2] Huang Xiangliang. The Boundless Prospect of Mobile Education. *Computer World Network*, 2003. 07.
- [3] Ruan Jing. Business English Reading Teaching under the Concept of Mobile Learning. 2016. 06.
- [4] Xu Min, Li Po, Zhou Ling. Research on the Teaching Reform of Business English Majors in Higher Vocational Colleges Based on Mobile Learning Model. *Overseas English*, 2015. 11.

Project: 2021 Qingdao City College "Education and Teaching Research Project" -- "A study on the Application of Nanolearning in Business English Teaching from the Perspective of Mobile Learning"(Project No.2021009B)



# The Death Penalty Should Not Continue To Exist:

## Abolition And Replacement Of The Death penalty In China's Criminal Justice System

Yuemin Chen

China University of Political Science and Law, Beijing 102249, China.

---

**Abstract:** At present, many countries around the world have abolished the death penalty or no longer impose the death penalty, while China still maintains a relatively high scale of death sentences relative to these countries; in practice, the death penalty has many problems, such as undermining human rights and leading to the irreparable harm of unjust and false convictions, etc. As China's socialist rule of law and the study of human rights develop, the question of whether or not to abolish the death penalty, and whether or not China can develop a system that can replace the death penalty, will also need to be further researched in depth.

**Keywords:** Death penalty; Alternative punishment; Human rights; Chinese criminal

---

### Introduction

With the development of society, economy and culture, the retention or abolition of the death penalty is controversial in the academic world. In the world, there are most countries have abolished the death penalty, and there are also countries that retain the death penalty but have not been sentenced to death for a long time. But the death penalty still exists in our country, of course, for the system of the death penalty in our country, and there is also a controversy on the existence of the abolition of the death penalty. Supporters of the death penalty argue that it is an effective deterrent for crime and serves as a form of justice for victims and their families. They also believe that certain crimes are so heinous that the perpetrators do not deserve to continue living.

On the other hand, opponents of the death penalty argue that it is morally wrong to take another person's life, regardless of the crime they have committed. They also point out that the death penalty disproportionately affects marginalized groups and can lead to innocent people being executed. Additionally, there is evidence that the death penalty does not serve as a deterrent for crime. States without the death penalty often have lower murder rates than those with it, and studies have shown that states with the highest execution rates also have the highest murder rates. Another aspect of the controversy is the risk of executing innocent individuals. Despite advancements in forensic science, there have been cases where people on death row were later found to be innocent and exonerated. This highlights the possibility of grave injustices being carried out in the name of the death penalty. Further complicating the issue is the cost associated with carrying out capital punishment. The lengthy appeals process and specialized legal representation required for death penalty cases can be financially burdensome for states.

Based on what has been said above, this paper takes the position that China should abolish the death penalty system, and offers five ways in support of this position: development of the death penalty system in China, implementation of the death penalty system at home and abroad, the death penalty and the purpose of punishment, the dilemma of the death penalty system in China, alternative systems to the death penalty. Section 1 addresses the development of China's death penalty system from pre-Qin to modern China. Section 2 addresses the history of the survival and abolition of the death penalty system in the Americas, Europe and Asia by comparison. Section 3 addresses the purpose of the death penalty as a punishment. Section 4 addresses the dilemma of China's death penalty system. Section 5 address the alternatives to the death penalty. And the final section offers a summary and a conclusion in support of the paper's position that the death penalty system in China should be abolished.

### 1. History and development of the death penalty system in China

The practice of capital punishment, or the death penalty, has a long history in China dating back to ancient times. It has undergone significant changes and developments over the centuries, influenced by cultural, political, and legal factors.

## **1.1 Ancient China (Pre-Qin dynasty)**

In ancient China, the death penalty was used as a means of punishing severe crimes such as murder, treason, and rebellion. The earliest known death penalty law was the “Law of the Twelve Tables” created during the Zhou dynasty (1046-256 BCE). This law prescribed the death penalty for 12 different crimes, including murder, kidnapping, and robbery.

## **1.2 Imperial China (Qin dynasty - 1911)**

Throughout imperial China, the use of the death penalty continued to be prevalent. However, the methods and severity of punishment varied depending on the dynasty and the ruler’s ideology. During the Tang dynasty (618-907), for example, the death penalty was rarely used, and alternative forms of punishment such as exile were favored. During the Qin dynasty (221-207 BCE), the first unified empire in Chinese history, the death penalty was widely used as a tool to maintain social order and punish dissent. The ruler of the Qin dynasty, Emperor Shihuangdi, is famous for his harsh use of the death penalty, which included methods such as dismemberment, beheading, and boiling alive. Under the Ming dynasty (1368-1644), the laws became more codified, and specific criteria were established for sentencing someone to death. The Qing dynasty (1644-1911) followed suit, and the judicial system became even more formalized and systematic in its approach to implementing the death penalty. However, the death penalty remained a common form of punishment for various crimes throughout imperial China.

## **1.3 Republican Era (1912 - present)**

When the Republic of China was founded in 1912, a new criminal code was introduced, which did away with some of the more brutal methods of execution, such as dismemberment and boiling alive. However, the death penalty remained a prevalent form of punishment, and its use intensified during periods of political instability.

After Mao’s death in 1976, there was a shift towards a more regulated use of the death penalty. In 1979, a new criminal code was introduced, reducing the number of crimes punishable by death from 44 to 33. In the following decades, there were further reforms aimed at limiting the use of the death penalty and ensuring fair trials for defendants.

Current Status of the Death Penalty in China Today, the death penalty remains a legal form of punishment in China, but it is used much less frequently than in the past. In 2020, China ranked first in terms of the number of executions carried out.

However, this number has been steadily decreasing in recent years due to efforts to reform the justice system.

In 2007, China enacted a law that requires all death sentences to be reviewed by the Supreme People’s Court before being carried out. This review process has resulted in a lower rate of executions and has led to more stringent standards for evidence and trials.

## **1.4 Sub-Conclusion: trends in the decreasing use of the death penalty**

The development of the death penalty in China has undergone significant changes throughout history. From its harsh and brutal use in ancient times to its regulation and decreasing use today, the death penalty reflects the changing attitudes and values of Chinese society. While it remains a controversial issue, it is clear that efforts are being made to reform and regulate its use in modern China. Overall, the scope of the use of the death penalty in China and the frequency of its occurrence in sentences is gradually decreasing.

## **2. The history of the survival and abolition of the death penalty system in the Americas, Europe and Asia by comparison**

The history of the death penalty system in the Americas, Europe and Asia has been marked by both its survival and eventual abolition. While there are variations in the use and implementation of capital punishment among these regions, there are also some common themes in the evolution of their approaches.

### **2.1 Americas**

In the early colonial period, the death penalty was widely used in the Americas as a means of maintaining order and enforcing social control. This was particularly evident in the harsh punishments imposed by the Spanish and Portuguese empires on enslaved Africans and

indigenous populations. However, in the 18th and 19th centuries, there were movements for reform and abolition of the death penalty in the United States and Canada, driven by ideas of human rights and the Enlightenment philosophy of rational justice.

Despite these efforts, the use of capital punishment continued into the 20th century, with several high-profile cases bringing attention to the flaws and inequalities in the legal system. In 1972, the US Supreme Court temporarily struck down the death penalty as unconstitutional, citing its cruel and unusual nature. However, it was later reinstated in 1976, with stricter guidelines for its application. Over time, several states in the US have abolished the death penalty, and today it is only legal in some states.

## **2.2 Europe**

Europe has a long and complicated history with the death penalty. Beccaria had advocated the abolition of the death penalty in his work, but of course it was not taken seriously at the time. Throughout medieval times, it was widely used as a form of punishment for crimes ranging from treason to theft. In the late 18th century, during the Age of Enlightenment, many European countries began to question the legitimacy of capital punishment and the potential for miscarriages of justice.

One key event that spurred the move towards abolition in Europe was the French Revolution, where the use of the guillotine became a symbol of state brutality. In 1867, the Grand Duchy of Tuscany abolished the death penalty, becoming the first European state to do so. This sparked a wave of abolition in other countries, with Russia, Norway, and Germany all following suit in the late 19th century.

Today, the death penalty is banned in all European Union member states. However, Belarus remains the only country in Europe that has not completely abolished it.

## **2.3 Asia**

The use of the death penalty has been deeply ingrained in Asia's legal systems for centuries. In many Asian societies, it was seen as a necessary form of punishment to maintain social order and deter crime. This mindset continued well into the 20th century, with countries such as China, Japan, and India still practicing capital punishment.

However, there have also been movements for reform and abolition in some Asian countries. In 1947, India abolished the death penalty except for extraordinary cases such as wartime offenses. Similarly, Nepal abolished the death penalty in 1990, citing humanitarian principles. Today, the death penalty is still actively used in several Asian countries, including China, North Korea, and Iran.

## **2.4 Sub-Conclusion**

In conclusion, the history of the survival and eventual abolition of the death penalty in the Americas, Europe, and Asia reflects the ongoing debate surrounding its use and effectiveness as a form of punishment. While progress has been made in reducing its use, there remain differing views on its fairness and necessity. As societies continue to evolve and reassess the value of human life, it is likely that the debate will continue and perhaps lead to further changes in the use of capital punishment worldwide.

# **3. The purpose of the death penalty as a punishment**

## **3.1 The purpose of the punishment**

The purpose of punishment in criminal law is to promote justice and maintain social order.

It involves imposing penalties on individuals who have violated the laws of society, with the aim of preventing future wrongdoing and deterring others from committing similar offenses.

One of the main goals of punishment in criminal law is retribution. This means that offenders should face consequences for their actions in proportion to the harm they have caused. By punishing an individual for their crime, it serves as a form of just punishment and satisfies the need for revenge or "an eye for an eye" mentality.

Another purpose of punishment is deterrence. By imposing penalties on criminals, it sends a message to potential offenders that there will be consequences for their actions. This is known as general deterrence, where punishment acts as a warning to society at large. On an

individual level, it can also serve as a specific deterrence, meaning that the punishment will deter that particular offender from repeating their offense in the future.

Punishment also has a rehabilitative purpose in criminal law. This involves addressing the underlying issues that led an individual to commit a crime and providing them with the necessary resources and support to reform and become law-abiding citizens.

This approach aims to address the root causes of criminal behavior and reduce the likelihood of reoffending.

Furthermore, punishment can serve as a form of incapacitation. By incarcerating or otherwise restricting the freedom of convicted criminals, it prevents them from committing further crimes while serving their sentence. This helps protect society from dangerous individuals and maintains public safety.

Lastly, punishment in criminal law also serves a symbolic purpose. It reaffirms the values and norms of society, reflecting the seriousness of certain offenses and reinforcing the idea that crime will not be tolerated. It also provides closure for victims and their families by acknowledging the harm that was done and holding the perpetrator accountable for their actions.

In conclusion, the purpose of punishment in criminal law is multifaceted. It serves to promote justice, maintain social order, and protect society from further harm. By imposing penalties on offenders, it aims to deter future criminal behavior while also providing opportunities for rehabilitation and societal reintegration.

### **3.2 The death penalty does not fully serve the purpose of punishment**

As mentioned above, one of the purposes of punishment is rehabilitation and reintegration. However, the permanent and irreversible nature of the death penalty renders it incapable of achieving these objectives. Once a criminal is executed, there is no opportunity for them to serve their time, reflect on their actions, and regret their wrongdoings. Consequently, the opportunity for rehabilitation is also forfeited, as the criminal is unable to undergo any educational or rehabilitative programs aimed at addressing the root causes of their actions.

In other words, when a criminal is executed, they lose their right to life and are unable to be rehabilitated through education or other forms of rehabilitation, preventing them from reintegrating into society. As a result, the goals of punishment and rehabilitation cannot be achieved.

## **4. The lack of fairness and impartiality in the application of death penalty procedures**

There are several reasons why the death penalty should be abolished in China.

First and foremost, the use of the death penalty in China is highly controversial and raises serious concerns about human rights.

Furthermore, there is a lack of transparency and due process in China's judicial system, leading to a high risk of wrongful convictions and miscarriages of justice. This is especially concerning when considering that the death penalty in China can be imposed for a wide range of crimes, including non-violent offenses such as drug trafficking and economic crimes. Without proper checks and balances, innocent individuals may face the ultimate punishment for crimes they did not commit.

In addition, studies have shown that the death penalty does not act as an effective deterrent to crime. In fact, countries that have abolished the death penalty have not seen an increase in crime rates. Instead, focusing on rehabilitation and addressing root causes of crime has been proven to be a more effective approach to reducing crime rates.

Moreover, the death penalty goes against fundamental principles of human rights and dignity. Every individual has the right to life, and the use of the death penalty violates this basic human right. It also denies the possibility of rehabilitation and redemption for individuals who may have committed a crime, disregarding the potential for positive change and growth.

Lastly, the death penalty disproportionately affects marginalized and vulnerable populations, including those with low socioeconomic status and minority groups. Studies have shown that individuals from these groups often do not have access to quality legal representation, increasing their likelihood of receiving a death sentence.

In conclusion, the death penalty in China should be abolished due to its violation of human rights, lack of transparency and due process, ineffectiveness as a deterrent, disregard of rehabilitation, and disproportionate impact on marginalized populations. It is time for the Chinese government to reconsider the use of this outdated and inhumane punishment and instead focus on alternative forms of justice that

prioritize fairness, accountability, and rehabilitation.

## 5. Alternative method to the death penalty

One alternative method to the death penalty is life imprisonment without parole. This means that instead of being sentenced to death, the individual would spend the rest of their life in prison with no chance of release.

This alternative allows for punishment, as the individual will still be serving a significant amount of time in prison, but it avoids the irreversible nature of the death penalty. Although life imprisonment also undermines human rights to a certain extent, it can be seen as a reasonable transitional alternative to the direct death penalty.

Another alternative is restorative justice. This approach focuses on repairing the harm caused by the crime and facilitating healing for both the victim and the offender. It involves holding the offender accountable for their actions through various means such as restitution, community service, and rehabilitation programs. This approach seeks to address the root causes of criminal behavior and aims to reduce recidivism rates.

Some advocates also suggest implementing a system of graduated sanctions,

where the severity of punishment increases based on the severity of the offense committed. This would allow for more flexibility in sentencing and would not automatically lead to the death penalty for the most serious crimes.

Additionally, some suggest increasing access to mental health treatment as ways to prevent violent crimes from occurring in the first place. By addressing underlying issues such as access to mental illness, it is believed that society can reduce the number of heinous crimes and therefore eliminate the need for the death penalty.

Ultimately, alternatives to the death penalty seek to address the concerns raised about capital punishment while still holding offenders accountable for their actions. These methods also prioritize rehabilitation and healing, rather than solely focusing on retribution.

## 6. Summary and Conclusion

The focal point of this paper is to present a compelling argument for the abolition of China's death penalty system. In light of this, five key ways are identified to support this position, each

highlighting a different aspect of the issue at hand. These five ways have been carefully chosen to provide a comprehensive and thorough overview of the complexities and controversies surrounding the death penalty system in China. Through this multifaceted approach, this paper aims to shed light on the pressing need to dismantle the current system and to call for alternative means to address crimes and uphold justice within the Chinese society.

The first section of this paper delves into the development of China's death penalty system, stretching back to the pre-Qin era and tracing its evolution to modern China. In the second section, the paper looks beyond the borders of China and examines the history of the death penalty in contrasting regions, specifically, the Americas, Europe, and Asia. Through this comparative analysis, it becomes clear that the death penalty has been scrutinized and challenged in many parts of the world, with some countries having abolished it entirely. The third section shifts the focus to the purpose of the death penalty as a form of punishment. While the death penalty has traditionally been justified under the premise of deterrence, retribution, and rehabilitation, this section delves into the underlying issues and contradictions surrounding these justifications. It argues that the objectives of the death penalty, while perhaps having been relevant in centuries past, no longer align with the evolving legal, ethical, and moral demands of a modern society. Section four tackles the dilemma of China's death penalty system, which has been subject to intense criticism and scrutiny on numerous fronts. The final section of this paper offers alternative systems to the death penalty that can be implemented in China. It explores the successes and failures of alternative systems in other countries and presents a compelling case for their implementation in light of the shortcomings of the death penalty system. These alternative systems include life imprisonment without parole, restorative justice, increasing access to mental health treatment and restorative justice.

## References

[1] LU, HONG & MIETHE, Terance D., China's Death Penalty: History, Law, and Contemporary Practices, p. 28 (2007).

[2] ZHANG, Ruijie & JIANG, Yulu, The Debate over The Retention or Abolition of The Death Penalty: A Reflection Centered on

Criminal Policy, Journal of Jilin TV & Radio University, no. 5, p. 69-71 (2022).

[3] HOOD, Roger & HOYLE, Carolyn, The Death Penalty: A Worldwide Perspective, p. 111-128 (4th ed., 2016).

[4] CHEN, Wei, Conceptual Advocacy and Conceptualization of Penal Exit Mechanisms from The Perspective of Positive Criminal Law , Academic Forum, no. 4, p. 1-14 (2023).

[5] LU, Shizhong, Re-Examining The Purpose of Our Penalties, Journal of Gansu University of Political Science and Law, no. 4, p. 12-24 (2021).

[6] XIONG, Moulin, The Practical Basis and Prospects of Death Penalty Reform, Huxiang Law Review, vol. 3, no. 4, p. 46-63 (2023).

[7] CHEN, Xingliang, The Controversy over The Abolition of The Death Penalty: Observations and Comments, China Law Review, no. 2, p. 151-154 (2015).

[8] ZHANG, Ruijie & JIANG, Yulu, The Debate over The Retention or Abolition of The Death Penalty: A Reflection Centered on Criminal Policy , Journal of Jilin TV & Radio University, no. 5, p. 69-71 (2022).

# The relationship between globalization and populism: Will globalization promote populism?

Lufei Wu

Xi'an Jiaotong-Liverpool University, Suzhou 215123, China.

---

**Abstract:** This study delves into the intricate relationship between globalization and populism, specifically exploring whether globalization acts as a catalyst for the rise of populist movements. Analyzing the waves of globalization and employing a case study of France, we demonstrate that economic and cultural aspects play pivotal roles in fuelling populism. The rise of far-right leader Marine Le Pen serves as a poignant example of how globalization impacts job opportunities and contributes to societal discontent.

**Keywords:** Globalization; Populism; Economic inequality; Cultural clash; Far-right movements

---

## Introduction

Globalization is an inevitable trend in contemporary society. As technology and science develop, the integration of economics, culture, and community gradually becomes a phenomenon. Although globalization brings plenty of benefits, such as travel mobility, free trade, and international education, it also has some features that negatively affect other aspects. With globalization deepened, other negative problems arose, such as climate change, terrorism, and migration. Populism on the far-right wing increases simultaneously.

In recent years, populism has become a global topic. Particularly in Western countries, populism spreads quickly. Various populist movements appear, such as anti-EU demonstrations in Greece, Brexit in the United Kingdom, and Pegida in Germany. The slogan of these movements usually focuses on domestic people and opposes immigrants from other countries, especially Muslim immigrants. Moreover, populism occurred on a large scale in Western countries and caused social unrest.

Globalization and populism interact with each other; in particular, globalization positively affects the appearance of populism. The following will briefly introduce the definition and relationship between globalization and populism, then use France as a case study.

## 1. The concept of globalization and populism

To explain why globalization promotes populism, relative concepts must be defined. Globalization also deemed “hyper-globalization,” means integration in most fields, not only economics but also culture and politics. Simply speaking, it is interconnected and interdependent. Giddens (1991) UNITED KINGDOM”, “ISBN”: “978-0-7456-7711-8”, “publisher”: “Polity Press”, “publisher-place”: “Chichester, UNITED KINGDOM”, “source”: “ProQuest Ebook Central”, “title”: “The Consequences of Modernity”, “URL”: “http://ebookcentral.proquest.com/lib/liverpool/detail.action?docID=1184142”, “author”: [ { “family”: “Giddens”, “given”: “Anthony” } ], “accessed”: { “date-parts”: [ [ “2022”, 12, 8 ] ], “issued”: { “date-parts”: [ [ “1991” ] ] }, “label”: “page”, “suppress-author”: true }, “schema”: “https://github.com/citation-style-language/schema/raw/master/csl-citation.json” } believes that events occurring thousands of miles away intensify global social relations and vice versa. Transnational firms, which account for 25% to 30% of global production, 70% of international commerce, and 80% of global investment, are a rising part of the global political economy (WTO, 2021). Globalization has three waves: the first is in the colonization era, the second is in the Industrial Revolution, and the last is in technological development. Three waves of globalization benefited Western developed countries. Davos (2018) believes that the current era represents the fourth wave of globalization: artificial intelligence. China is rising quickly, and other emerging economic countries are subsequently following, yet Western countries are leaving behind. So, populism appears with globalization.

The definition of populism is debatable, but most scholars believe it is an ideological trend. As per Edward Shils (1956) “author”: [ { “family”: “Shils”, “given”: “Edward” } ], “issued”: { “date-parts”: [ [ “1956” ] ] }, “label”: “page”, “suppress-author”: true }, “schema”: “https://github.com/citation-style-language/schema/raw/master/csl-citation.json” } , populism is a kind of public discontent against the order imposed on society by a governing elite that is considered to hold a monopoly on power, property, breeding, and culture. Populism may also be based on

three other ideas: first, that “the people” are sovereign and superior to their rulers; second, that there should be a direct line of communication between “the people” and their government; and finally, that “the will of the people” is affiliated with justice and fairness. Canovan (1999) concentrated on the distinctions between movements and parties under the label “populist.” Huber and Schimpf (2017) provide a strict definition of populism, a call to action, a criticism of the ruling class, and the notion that politics ought to reflect the “public will.” Since populism has an exclusive nature, its adherents seldom consider the entire globe while making decisions. They think other nations and individuals are their foes who will interfere with their advantages.

## 2. Globalization fuels populism

Globalization will strengthen populism and have negative consequences. How globalization fuels populism embodies two fields: economics and culture (Rodrik, 2021). In terms of economics, due to economic inequality among countries, people in countries with trade deficits feel deprived and dissatisfied. Then, they accuse outsiders of stealing their jobs or lowering their wages and incomes. Many Western academics, including Kalinowski, believe that East Asia’s trade surplus contributes to global economic imbalance (Kalinowski, 2015) Japan and Korea – are playing an increasingly important role in governing the global economy. Their global political rise is frequently discussed in binary terms in which the ‘realist’ assumption of inevitable conflict between rising and declining powers is contrasted with the ‘liberal’ assumption of the region’s growing integration into international institutions. This article offers an alternative explanation for East Asia’s global political role by shifting attention to the internal dynamics of the East Asian development model. This ‘second image’ interpretation of international political economy focuses on the ways in which domestic political economies influence international negotiations and institutions. Furthermore, this article departs from a focus on national political economies and considers the global role of the East Asian model of capitalism as such. At the empirical level, this article investigates the role of East Asian G20 members in international macroeconomic coordination and in reducing global economic imbalances.”,”container-title”:”International Politics”,”DOI”:”10.1057/ip.2015.18”,”ISSN”:”1384-5748, 1740-3898”,”issue”:”6”,”journalAbbreviation”:”Int Polit”,”language”:”en”,”page”:”760-778”,”source”:”DOI.org (Crossref. For example, the widening trade gap between China and the United States is increasing, and the US maintains a trade deficit. Besides, globalization benefits the rich and the incumbent while harming the poor and the middle class. The rich get richer, and the poor get poorer because of capital flow. Therefore, globalization will inevitably exaggerate the class conflict in society. The middle and lower classes will be irritated, resulting in a form of social radicalism.

From a cultural perspective, not only are immigrants suffering culture shock, but domestic people also think immigrants influence their jobs and welfare. Because Islamic immigrants have different religious beliefs and lifestyles, Westerners will experience cultural conflicts. The perceived differences between Islam and the West have been exaggerated by increased communication and interaction between the two religions (Huntington, 1993). Domestic people believe their income has decreased due to economic inequality and the euro crisis. Low-income people will look at the competitors who take over their jobs. Then, outsider immigrants will be the target of populism. In France, immigration increases domestic support for far-right candidates. Other countries have similar outcomes.

Therefore, populism is emerging because of economics and culture in the context of globalization. Globalization frustrates the domestic people, and then populism occurs. Populists begin to backlash against the challenges of globalization and even oppose globalization. There have been more and more voices that prefer de-globalization and regaining independence.

## 3. Populism in France

Populism is fuelled by the context of globalization, which can be seen in France. By studying far-right Marine Le Pen, a recent political star with a long quest for power, insights about populism in this country can be garnered. In democratic countries, every domestic person has the right to vote, and election outcomes can reflect popular opinion. In France and most Western countries, the rise of right-wing populist parties is a trend. So, vote data, electorate composition, and election manifestos can show that populism occurred in France due to globalization.

Since the 21st century, the deepening of globalization has brought changes to the industrial structure of France and other European countries. The service industry and high-tech industry have gradually replaced agriculture and traditional manufacturing. At the same time, as many immigrants move in to compete with residents for low-skilled jobs, many local low- and middle-income groups lose their job op-



portunities, resulting in a “sense of deprivation.” On the other hand, the refugee crisis has brought further shocks to Europe, exacerbating its economic woes. Europe’s mainstream political parties, which support globalization and EU integration, often do not offer good solutions, and far-right populists echo some popular voices.

Marine Le Pen, as a firm populist, gradually gained popularity. She is a French politician who presided over the National Rally faction of the National Assembly and ran for three French presidential elections. Le Pen advocates her party’s historical policies, particularly emphasizing strong anti-immigrant, nationalist, and protectionist measures. Speaking of immigration, she believes that France needs to “de-Islamisation,” including a limitation on legal immigration, a ban on ritual slaughter, and a restriction on circumcision. Regarding economic policy, Le Pen is a trade protectionist who believes in economic nationalism, adding trade barriers to protect domestic workers, favoring government intervention, and opposing globalization. In 2012, Marine Le Pen received 17.90% of the vote, 21.3% in 2017, and 23.15% in the first round of the presidential election in 2022. Despite Le Pen ultimately falling to Emmanuel Macron in the second round of the 2022 presidential election, she received 41.45% of the vote in the second round of the race. As a result, Le Pen’s popularity percentage increased significantly.

The sociology of voters in the 2022 election is intriguing, according to Ipsos data (2022). A clear victory for Emmanuel Macron was forged on the vote of the oldest: 59% of the votes cast were in the 60–69 age category, and up to 71% were among voters over 70 years of age. Regarding professional classes, 77% of Macron voters are executives, 59% are in the intermediate professions, but 67% of Le Pen voters are workers, and 57% are employees. That means most Macron supporters are upper-class and wealthy business owners, while most worker classes support Le Pen. In addition, Marine Le Pen’s base has widened considerably compared to 2017, with 11 points gained among workers (56% in 2017) and employees (46% in 2017).

Individual policy preferences can cause electoral outcomes, which means voting for populist parties or candidates increases. Most people’s voice stems from the party programs and candidate ideologies. Emmanuel Macron had beaten Marine Le Pen in all income categories in 2017 but was just ahead of the lowest category in 2022. Despite the victory, the meritocracy Macron represents is losing its edge. The French believe that globalization with increasing immigration will take their jobs and lose “France first.” The competition has intensified, and French discontent has grown. More than two-thirds of those who say they are “satisfied with their life” voted for Emmanuel Macron (69%), but nearly 80% of those who are not voted for Marine Le Pen (79%).

## 4. Conclusion

France’s political circle reflects populism against globalization, and the political movement is not isolated; many other like-minded countries are under globalization. For example, with the newly elected president of Italy, Giorgia Meloni, in 2022, and the previous US president, Donald Trump, populism is spreading among Western countries.

Even if some people oppose globalization, it is an unavoidable trend in the global village to integrate economy, culture, and even politics. Globalization, on the other hand, fuels populism and escalates regional conflicts. People oppose globalization, vote for the far-right party, and conduct social movements. So, under globalization, how to benefit from it and decrease populism is a challenge for all countries.

## References

- [1] Canovan. (1999). Trust the People! Populism and the Two Faces of Democracy. <http://journals.sagepub.com/doi/epdf/10.1111/1467-9248.00184>
- [2] Giddens, A. (1991). *The Consequences of Modernity*. Polity Press. <http://ebookcentral.proquest.com/lib/liverpool/detail.action?docID=1184142>
- [3] Huber, R. A., & Schimpf, C. H. (2017). On the Distinct Effects of Left-Wing and Right-Wing Populism on Democratic Quality. *Politics and Governance*, 5(4), 146–165. <https://doi.org/10.17645/pag.v5i4.919>
- [4] Huntington, S. (1993). The Clash of Civilizations. *Foreign Affairs*, 72(3), 22–49. <https://doi.org/10.2307/20045621>
- [5] Kalinowski, T. (2015). Second image IPE: Global economic imbalances and the ‘defects’ of the East Asian development model. *International Politics*, 52(6), 760–778. <https://doi.org/10.1057/ip.2015.18>
- [6] Rodrik, D. (2021). Why Does Globalization Fuel Populism? *Economics, Culture, and the Rise of Right-Wing Populism*. Annual

Review of Economics, 13(1), 133–170. <https://doi.org/10.1146/annurev-economics-070220-032416>

[7] Second tour: Profil des abstentionnistes et sociologie des électeurs. (2022). Ipsos. <https://www.ipsos.com/fr-fr/presidentielle-2022/second-tour-profil-des-abstentionnistes-et-sociologie-des-electorats>

[8] Shils, E. (1956). *The Torment of Secrecy: The Background and Consequences of American Security Policies*. Glencoe: The Free Press.

[9] World Economic Forum. (2018). If this is Globalization 4.0, what were the other three? World Economic Forum. <https://www.weforum.org/agenda/2018/12/if-this-is-globalization-4-0-what-were-the-other-three/>

[10] WTO. (2021). World Trade Statistical Review ([https://www.wto.org/english/res\\_e/statis\\_e/wts2021\\_e/wts2021\\_e.pdf](https://www.wto.org/english/res_e/statis_e/wts2021_e/wts2021_e.pdf)). 136.

# Balancing authority and affinity: Communication strategies in preschool teachers' home cooperation

Ruijun Ran

Guizhou Minzu University, Guiyang 550025, China.

---

**Abstract:** This study aims to explore how to effectively balance authority and affinity in the communication between preschool teachers and parents, so as to promote good cooperation between family and school. First of all, this paper analyzes the importance of home communication in early childhood education, and the necessity of maintaining the balance between authority and affinity in home communication. Secondly, this paper deeply discusses the influence of multiple factors such as culture, social background, teachers' personal factors, parents' expectations and school environment on home communication and puts forward a series of countermeasures and suggestions. Including continuous improvement of professional knowledge and skills, maintenance of open and friendly communication attitude, implementation of regular parental communication and feedback mechanism, promotion of co-parenting cooperation model with parents, regular self-reflection and communication strategy adjustment. These strategies aim to help preschool teachers and parents establish a cooperative relationship based on trust and respect, and jointly promote the health and all-round development of children.

**Keywords:** Authority and affinity; Preschool teachers; Home cooperation; Communication strategies

---

## Introduction

According to the 2021 Guizhou Statistical Yearbook, 11,305 kindergartens will achieve a 99.9% enrollment rate for school-age children, signifying the success of universal access in preschool education. This marks a stage of comprehensive popularization and high-quality development, emphasizing the crucial role of home communication.

Balancing teacher authority and affinity in communication with parents is a challenge. Teachers must convey authority based on professional knowledge, experience, and responsibility, avoiding imposition. They also need to exhibit sufficient affinity through friendly, respectful, and effective communication. This balance is crucial for winning parental trust and maintaining the professional status of educators.

Achieving this balance is a challenge that every preschool teacher must face, essential for professional development and the healthy growth of early childhood education. Future studies should systematically explore the relationship between home communication and teacher authority, focusing on how teachers achieve this balance. Introducing more rigorous and objective research methods is crucial for accurate and practical guidance in early childhood education.<sup>[1]</sup>

## 1. Analysis of the reasons

In early childhood education, how teachers balance authority and affinity in home communication is an extremely critical issue. It is not only related to the cooperative relationship between teachers and parents, but also directly affects the effect of children's education.

### 1.1 Cultural and social background

Cultural and social contexts significantly influence the balance between teacher authority and affinity. In collectivist cultures, teachers hold high authority; in individualistic cultures, emphasis is on a teacher's affinity.

Geert Hofstede's research correlates differences in cultural backgrounds to a model based on four dimensions: individualism versus collectivism, large versus small power distance, strong versus weak uncertainty avoidance, and masculinity versus femininity.

In certain societies, teachers are considered the second "parent," enjoying high social status. In other environments, child-centered education requires teachers to prioritize coordination and communication, necessitating high affinity and communication skills. Teachers need cultural awareness to establish effective cooperative relationships with parents and promote children's healthy growth.

## **1.2 Teacher factors**

Teacher factors significantly impact home-school cooperation. Balancing authority and affinity is key for effective communication. Educators with democratic beliefs foster open relationships and emphasize affinity. In contrast, an authoritarian approach may prioritize professional standing, leading to more formal communication. Effective communication skills, such as clear information delivery and emotional management, are crucial. These factors influence teacher-parent interactions, shaping overall home communication quality. Parental factors, including education and expectations, also play a role. Higher-educated parents tend to cooperate, while conflicts arise with differing expectations. Institutional and environmental factors, such as school policies and culture, shape communication dynamics.<sup>[2]</sup> Clear policies support effective communication, while cultural openness encourages collaboration. In kindergarten communication, challenges like conflicts stem from various factors. Balancing teacher authority and affinity is crucial for building trust in the educational environment.

## **2. Countermeasures and suggestions**

In early childhood education, effective teacher-parent communication, balancing professional authority and affinity, is crucial for fostering trust, understanding, and targeted support for children's all-round development.

### **2.1 Continuous improvement of professional knowledge and skills**

Continuous improvement of professional knowledge and skills is vital for preschool teachers to naturally exhibit authority in home communication. This involves participating in vocational training, reading professional literature, and obtaining relevant qualifications. Close communication with peers through activities like case sharing further enhances teachers' knowledge and methods, promoting a solid professional foundation for effective home cooperation.

### **2.2 Maintain an open and friendly communication attitude**

Preschool teachers should maintain an open and friendly attitude, set fixed communication times, and transparently share a child's progress. Sincere and respectful communication, along with receptivity to parents' opinions, helps foster collaboration. Emotional wisdom is essential to understand and respond to parents' emotions, providing support when needed. Accepting parental suggestions and discussing solutions collaboratively strengthens the teacher-parent relationship. Initiatives like inviting parents to participate in activities establish cooperation, fostering mutual respect and support.

### **2.3 Implement regular parent communication and feedback mechanism**

Effective communication involves regular parent communication times and digital tools like the Home Communication APP for real-time updates on children's progress. Encouraging parental feedback through suggestion boxes, questionnaires, or seminars is essential. Teachers should respond promptly and professionally, following up to assess improvements and understand new concerns. Organizing parent workshops facilitates information exchange.

Establishing a regular summary and evaluation mechanism allows teachers to assess the implementation of the system, identify problems, and set improvement goals. This continuous optimization aims to enhance home cooperation and promote children's all-round development.<sup>[3]</sup>

### **2.4 Promote the cooperative mode of co-parenting with parents**

Promoting co-parenting involves regular parent education workshops and collaborative discussions on educational topics. Encouraging parent involvement through volunteer service or participation days fosters a close parent-teacher relationship. Jointly designing and implementing projects enhances parental participation in educational activities. Establishing a resource library for parents facilitates the sharing of educational resources. Creating a child's growth file in collaboration with parents helps them understand the child's development.

Regular evaluations enable adjustments to strategies, ensuring sustainability. Semester discussions with parents allow for feedback and collaborative planning, optimizing the co-education model for the common growth of teachers, parents, and children.<sup>[4]</sup>

## 2.5 Regular self-reflection and communication strategy adjustment

Preschool teachers should regularly self-reflect on communication, adjusting strategies for authority and affinity. Scheduled reviews, using recordings or observations, offer an objective perspective. Sharing reflections with team members fosters diverse insights and collective improvement. Teachers devise clear adjustment plans with specific actions and outcomes, using a timetable for systematic self-improvement. This demands awareness, responsibility, and collaborative learning for effective balance in parent communication.

## 3. Conclusion

In early childhood education, home communication is vital for children's growth but presents challenges due to diverse educational views and cultural backgrounds. Balancing authority and affinity is crucial—authority establishes leadership, while affinity builds trust. A teacher with both gains parent trust, fostering an ideal environment. Implementing comprehensive strategies supports effective cooperation, creating a harmonious home communication system and an all-encompassing educational environment for children.

## References

- [1] Pan Sijia. Introduction to young children with different ages communications strategy [J]. Journal of popular science education (science), 2018 (7) : 98. DOI: 10.16728 / j.carol carroll nki KXDZ. 2018.07.091.
- [2] Liang Qiuxia. Research on Parents' Communication Strategies for educating children through joint efforts [J]. China Journal of Multimedia and Network Teaching (Xunjun),2018(07):60-61.
- [3] Dong Yan, Wang Fei. [3] Study on wechat support model and parents' recognition of home-school cooperation [J]. China Audio-Visual Education,2017(02):122-127.]
- [4] Hofstede G. Cultural differences in teaching and learning [Z]. Elsevier BV, 1986: 301–320(1986).

# Analysis on the role of ideological and political elements in college badminton

Shuaijun Hu, Mida Dai

SouthWest Petroleum University, Chengdu 610500, China.

---

**Abstract:** Ideological and political education is an indispensable key link in the special badminton teaching in colleges and universities. It not only pays attention to the physical and mental health of college students, but also promotes the students to master the special badminton technology. This paper discusses the practical significance of integrating ideological and political elements into badminton courses in colleges and universities. Through the in-depth analysis of the difficulty of integrating professional knowledge with ideological and political elements, the problems of teachers' quality and ideas, and the problems of students' individual differences and acceptance, this paper reveals the challenges faced in the badminton specialized courses. The difficulty of the integration of professional knowledge and ideological and political elements is mainly reflected in the technical characteristics, the particularity of disciplines and the division of disciplines, while the problem of teacher accomplishment and concept involves the understanding and recognition degree of PE teachers on ideological and political education.

**Keywords:** Badminton turn; Ideological and political elements; Physical education teaching

---

## 1. Ideological and political elements into the theoretical basis of college badminton courses

### 1.1 Ideological and political education theory

Political and ideological education. The orientation of ideological and political education to individual needs in the new era is the unity of regularity, epochal nature and pertinence, which is not only the necessary demand to follow the law of the formation and development of human ideological and moral character, but also the actual demand to solve the individualized dilemma of ideological and political education, and the inevitable requirement to promote the high-quality development of ideological and political education.<sup>[1]</sup> Political and ideological education aims to guide students to form correct political positions and ideological concepts. In badminton courses, the relationship between sports and social politics can be explained to stimulate students' awareness of social responsibility and political participation. For example, by discussing the political impact of sports throughout history, students develop sensitivity to social and political issues. In the badminton elective courses, students can be guided to respect the rules and opponents by discussing the discipline and rules in sports events, and enhance their concept of rule of law. This helps to form students' good habits of abiding by the law.

### 1.2 Concept of all-round development

The concept of all-round development emphasizes the all-round development of individuals in many aspects, including intelligence, sports, aesthetic education, labor and so on. This concept has important implications for educational, social and individual growth. According to Marx's concept of comprehensive human development, sports should not only promote the development of human physical body and perceptual body, but also pay attention to helping human beings build a happy community through sports, and first emphasize the improvement of individual comprehensive quality to become a complete person.<sup>[2]</sup> The concept of all-round development advocates the cultivation of individuals in various fields, so that they not only have strengths in professional fields, but also can be comprehensively developed in many aspects such as thought, emotion, morality and social interaction. This will help to cultivate more comprehensive quality talents and improve the comprehensive competitiveness of individuals. The second is to emphasize the diversity of human values and promote innovation and comprehensive ability. Therefore, the introduction of the concept of all-round development in college badminton courses can enable students to develop individual intelligence, sports quality and comprehensive literacy more comprehensively while cultivating professional skills, and provide a more solid foundation for their future career and social life.

## **2. Ideological and political elements into the university badminton curriculum challenges**

In the badminton elective courses, the problems of teacher quality and philosophy become a significant challenge that hinders the integration of professional knowledge with ideological and political elements. This challenge is mainly reflected in the lack of understanding of the concept of ideological and political education, and their tendency to emphasize the cultivation of professional skills while ignoring the ideological and political elements in teaching. On the one hand, physical education teachers usually receive special education and training in physical education, emphasizing the cultivation of sports skills, tactical training and physical quality. However, in this professional education system, the idea of ideological and political elements may not receive sufficient attention and in-depth understanding. The education teachers receive in the professional knowledge system emphasizes the teaching of subject skills, while the training and concept transmission in ideological and political elements are relatively small, which may make it difficult for teachers to naturally integrate ideological and political elements in teaching design. On the other hand, PE teachers may pay more attention to the imparting of subject knowledge and the cultivation of professional skills, and their understanding and recognition of ideological and political elements may be different. Because in their professional fields, they emphasize sports training and technical improvement, while ignoring ideological and political elements such as sports ethics and social responsibility to varying degrees. This makes the status of ideological and political elements relatively low in the minds of professional teachers, and it is difficult to be effectively reflected in teaching practice.

## **3. The ideological and political elements into the university badminton curriculum strategy research**

Designing scenario simulation and comprehensive case analysis is one of the strategies to integrate ideological and political elements into college badminton courses. This method not only stimulates students' interest in learning, but also improves the practicability of ideological and political elements in actual sports training, which has significant advantages and operability.

First of all, through the design of scenario simulation and comprehensive case analysis, the abstract ideological and political elements can be made more concrete and vivid, and closer to the actual experience of students. The introduction of specific situations in badminton training, such as moral decision-making in simulated games and ethical issues in team cooperation, can guide students to think about ethics and social responsibility in practice, so as to deepen their understanding of these ideological and political elements. Secondly, this method can cultivate students' ability of comprehensive analysis and problem solving. Comprehensive case analysis usually involves multiple aspects of knowledge, requiring students to make comprehensive analysis and judgment by using ethics, morality and other ideological and political elements on the basis of badminton professional skills. This cultivates the students' ability to think comprehensively, making them more able to cope with complex situations in the future. episodic memory refers to the memory of individual experiences that occur in specific time and space background.<sup>[4]</sup> In addition, this strategy increases the interest and interactivity of the course. Through scenario simulation, students can more intuitively feel the integration of ideological and political elements and badminton professional knowledge, which improves the attractiveness of learning. Comprehensive case studies can also be conducted through group cooperation to promote communication and discussion among students and form a common understanding and consensus.

In terms of operability, teachers can design relevant cases in combination with actual situations and real competition experience, and use teaching resources and technical means to simulate. With the help of advanced technology, such as virtual reality (VR) technology, teachers can create more realistic and vivid situations for students and improve the practicability of case studies. Teachers also have the flexibility to select or design cases according to students' level and interests to ensure that the cases are appropriate and challenging, prompting students to engage and think deeply. Therefore, the design of scenario simulation and comprehensive case analysis is an innovative and practical teaching strategy, which helps to organically combine ideological and political elements with badminton courses and improve students' learning motivation and comprehensive literacy.

## **4. Ideological and political elements into the practical significance of college badminton courses**

The integration of ideological and political elements into college badminton courses has far-reaching practical significance, which not only helps to cultivate students' overall quality, but also promotes higher education to develop in a more comprehensive and humanistic

direction. This process involves moral ethics, social responsibility, humanistic care and other aspects, which has a positive impact on the growth of students and the improvement of comprehensive literacy.

By integrating ideological and political elements into badminton training courses, we can cultivate students' all-round quality. Traditional sports courses focus on the cultivation of students at the technical and tactical levels, while the introduction of ideological and political elements enables students to cultivate more comprehensive qualities in addition to professional skills. Ethical and moral education can guide students to form correct values and moral concepts, and cultivate their sense of responsibility, civic consciousness and social participation ability, so as to lay a solid humanistic foundation for their future career and social communication.

In general, the integration of ideological and political elements into college badminton courses is not only conducive to the overall development of students, but also can guide students to form a positive outlook on life and social outlook. This has important practical significance for the innovation of higher education and the improvement of students' humanistic literacy, and lays a foundation for cultivating a new generation of talents with a sense of responsibility and mission.

## References

- [1] Zhao Benyan, Wang Jianxin. Multi-dimensional thinking of Ideological and Political Education for Individual needs in the New Era [J/OL]. Journal of Hohai University (Philosophy and Social Sciences Edition),1-8[2023-12-18]
- [2] Yu Sumei, Wang Xiaoyan. How can "Happy Sports" be confirmed? -- The value purport and realistic pursuit of Sports in the context of Marxist philosophy [J]. Journal of Physical Education,2023,30(06):1-8.
- [3] Wang Jian. The main problems and countermeasures of the development of school physical education in China in the new era [J]. Journal of Central China Normal University (Humanities and Social Sciences Edition), 2019,62(06):166-178
- [4] A study on the influence of emotional titer and self-reference on new/old effects of episodic memory [D]. Zhejiang University,2019.

About the author: Name: Hu Shuaijun, 1997.08, male, Han Nationality, born in Xinxiang, Henan province, master student, School of Marxism, Southwest Petroleum University, major in Marxist Theory

Dai Mida, January 11,1998, Huaihua City, Hunan Province, law School of Southwest Petroleum University, sports Humanities and Sociology



# Research on Strategies for Developing Language Sensibility in Upper Elementary Chinese Education

Li Jie

Xi'an Fengjing Primary School, Xi'an 710018, China.

---

**Abstract:** With the implementation of the 2022 version of the New Curriculum Standards for Compulsory Education Chinese (referred to as the Curriculum Standards hereafter), the focus on core literacy has become a central concern and inevitable trend in Chinese language teaching research. This paper, starting from the practical aspects of Chinese language learning in the fifth and sixth grades of primary school, investigates the language sensibility of upper-level students. Based on the findings regarding the sensibility status, it identifies a series of issues such as inappropriate methods and insufficient attention in the cultivation process and proposes specific strategies to address the current state of students' language sensibility.

**Keywords:** Language Sensibility; Students; Strategies

---

## 1. Conceptualization of Language Sensibility

### 1.1 Definition of Language Sensibility

The term "language sensibility" was initially introduced in the 1920s when Mr. Xia Miao Zun first defined the concept in the context of Chinese language education. Subsequently, educator Mr. Ye Shengtao further supplemented the definition as "a sensitive feeling towards language and words." Language sensibility research has continued to evolve, reaching unprecedented peaks in the late 20th century. Guided by various theoretical frameworks, language sensibility research has injected vitality and diversity into the field.

### 1.2 Characteristics of Language Sensibility

Examining the historical research, a consensus has been reached on several key characteristics of language sensibility, including:

- (1) Intuitiveness: the general explanation for intuitiveness is direct and non-logical reasoning, emphasizing speed, agility, and unconsciousness.
- (2) Individuality: Evident in diverse language styles, showcasing a strong personal touch.
- (3) Holistic Nature: As a language skill, language sensibility manifests through the overall presentation of abilities in listening, speaking, reading, and writing.
- (4) Creativity: Primary school students, drawing on past learning experiences, creatively imbue more meaning into concepts such as the "yue" (moon).

## 2. Language Sensibility Teaching in Chinese Education

### 2.1 What is Language Sensibility Teaching?

As the name implies, language sensibility teaching is "an instructional activity conducted to cultivate language sensibility. It involves activities aimed at perceiving and utilizing language to achieve educational goals, considering students' psychological and linguistic development."

### 2.2 Importance of Language Sensibility Teaching

The necessity of implementing language sensibility teaching can be summarized from several perspectives:

Firstly, competence of language sensibility is at the core of language abilities. Students' reading proficiency, oral communication, expressive skills, and organizational abilities in written language are closely linked to the manipulation of language sensibility. The essence of

Chinese language learning lies fundamentally in the study of language, following the pattern of “perception—comprehension—accumulation—application.”

Secondly, language sensibility cultivation contributes to moral education. The linguistic form and content of a text permeate the author’s thoughts and emotions. Through repeated perception of language materials conveying truth, goodness, and beauty, students assimilate, adapt, and modify their cognitive patterns.

### 3. Analysis of Issues in the Current State of Students’ Language Sensibility

The author conducted a sample survey on the language sensibility status of over 500 fifth and sixth-grade students in a primary school in Xi’an:

Survey Questionnaire on the Language Sensibility Status of Fifth and Sixth-grade Students in a Primary School in Xi’an (excerpt)

Survey Content	Options	Number of Respondents	Percentage
After multiple readings, can you achieve?	A	94	47%
	B	52	26%
	C	54	27%
How do you handle the “reading” aspect when studying course texts?	A	78	39%
	B	104	52%
	C	18	9%
How do you usually arrange your morning reading class?	A	31	15.5%
	B	100	50%
	C	29	14.5%
	D	40	20%
How many times do you usually read a course text?	A	98	49%
	B	67	33.5%
	C	35	17.5%
Do you think there is a significant correlation between reading and language learning ability?	A	114	57%
	B	50	25%
	C	36	18%
Do you have the habit of making simple annotations or writing reflections while reading articles?	A	38	19%
	B	88	44%
	C	74	37%
How would you rate your oral expression skills?	A	20	10%
	B	47	23.5%
	C	111	55.5%
	D	22	11%

To assess the current language sensibility level of primary school students, the author conducted a questionnaire survey involving 597 fifth and sixth-grade students in a primary school in Xi’an. A total of 597 questionnaires were distributed, with 502 valid responses collected (an effective rate of approximately 84.09%).

Based on the analysis of the questionnaire results, students generally acknowledge the importance of reading but do not emphasize it sufficiently in practice. They fail to develop the habit of thinking while reading and making timely reading notes. Most students engage in shallow reading, lacking critical thinking, and relying on teacher explanations for text comprehension. If students’ reading quality does not meet the standards, the cultivation of language sensibility becomes a theoretical concept without practical implementation.

#### 3.1 Lack of Good Reading Habits

The Song Dynasty philosopher Zhu Xi proposed the famous “Six Steps of Reading”, emphasizing that “the essence of reading lies in personal enrichment, and one should be able to derive insights and feelings from the text through reading.”.

### **3.2 Overreliance on Teacher Explanations**

Following recent curriculum reforms, the “authoritative role” of teachers is gradually diminishing, allowing students to become more active participants in the classroom, and enhancing their awareness as the main contributors to the learning process.

### **3.3 Insufficient Oral Training, Weak Language Organization and Expression**

Within the training phase of oral expression, teachers often simplify course content, inadequately implementing oral training, or substituting regular lessons to save time.

### **3.4 Lack of Language Accumulation, Weak Organizational Skills in Written Language**

Written language composition serves as another crucial benchmark for language proficiency. Common issues observed in writing instruction include difficulties in capturing and extracting key information from the prompt, frequent grammatical errors, incoherent sentences, a paucity of vocabulary, and a lack of aesthetic sense.

## **4. Strategies for Developing Language Sensibility Focused on Student Audience**

The process of forming students’ language sensibility is not instantaneous. It requires active engagement with language materials, internalizing these materials into cognitive structures, and reinforcing the learning through practical application. The author introduces the following strategies for cultivating language sensibility in student groups:

### **4.1 Critical Reading and Analysis, Appreciating Language**

- (1) Insightful Reading: Reading is a crucial step in Chinese language learning, occupying a significant portion of the curriculum.
- (2) Creating Scenarios: Language context influences the formation and content of language, and it affects the environmental setting in which language and words exist, influencing their meaning.
- (3) Analytical Contemplation: The ultimate goal of language learning is its practical application.

### **4.2 Extensive Reading and Knowledge Expansion**

(1) Wide Reading and Vocabulary Accumulation When students encounter a vocabulary word during reading, the information associated with that word stored in their “mental lexicon” is promptly activated. Typically, students with higher reading proficiency expend less time extracting information; while the students with weaker reading skills exhibit slower responses in capturing pertinent information, resulting in a comparatively delayed understanding.

(2) Utilizing Multimedia for Indirect Experience Accumulation Multimedia teaching aids, as auxiliary tools in Chinese language instruction, can compensate for students’ lack of life experience.

### **4.3 Transfer Training, Reinforcing Language Sensibility Application**

(1) Reading Notes Writing reading notes is the process of presenting the information after assimilation and adaptation. “the form of reading notes is simple and easy to operate; recording feelings at any time, possessing timeliness.” 19% of the surveyed participants who selected “yes” exhibited relatively strong language perception and expressive abilities in the subsequent written language tests.

(2) Comparative Imitation Writing Comparative imitation writing occurs after the study of Chinese literary texts. Students are tasked with mimicking the given text, using the text’s title as a prompt for their writing. The difficulty level of the material should align with the “zone of proximal development”. The second step involves modification, including group revisions and teacher guidance.

(3) Situational Writing The words “I write with my hand and speak with my mouth; how can tradition restrain me?” was mentioned by Huang Zunxian in Zagan. The situational writing involves on-the-spot composition in a specific context.

The current study primarily addresses issues related to cultivating language sensitivity identified through questionnaire surveys and teaching observations. While this paper may have limitations, it is hoped that it will serve as a catalyst, sparking further contemplation on

language sensitivity and its teaching methodologies.

## References

- [1] Ministry of Education of the People's Republic of China. New Curriculum Standards for Compulsory Education Chinese [R]. Beijing: People's Education Press. 2022
- [2] Wang Shangwen. On Language Sensitivity [M]. 3rd ed. Shanghai: Shanghai Educational Publishing House, 2006:17-20, 353-356.
- [3] Ye Shengtao. Collection of Ye Shengtao's Chinese Education Essays [M]. Beijing: Education Science Publishing, 1980:266.
- [4] Du Caoyong, et al. On Xia Miaozi's Chinese Education [M]. Zhengzhou: Henan Education Press, 1987:116.
- [5] Xu Yunzhi. Research on Language Sensitivity and Language Sensitivity Teaching [M]. Beijing: Higher Education Press, 2004: 12-20, 106-117.
- [6] Li Hailin. On Language Teaching [M]. Shanghai: Shanghai Educational Publishing House. 2000.
- <sup>[7]</sup> Ni Wenjin, Wang Rongsheng. Language Sensitivity: A Hotspot for Theory and Practice. Humanities · Language Sensitivity · Dialogue [C]. Shanghai: Shanghai Educational Publishing House, 2010: 243-247.

About the author: Li Jie (1992-), female, Han Nationality, Xianyang city, Shaanxi Province, primary school teacher, graduate student, Xi'an Fengjing Primary School, research direction: Language sense cultivation in primary school Language teaching.

# On the problems encountered in the development of non-profit organizations and optimization measures

Doudou Li, Wenchuan Li

College of Economics and Management, Zhejiang Agriculture and Forestry University, Hangzhou 310000, China.

---

**Abstract:** In recent years, China's non-profit organizations have developed rapidly and their social influence has been expanding. With the rapid development of non-profit organizations in China, there have been problems such as single source of funds, shortage of talents and imperfect operation system. In view of the problems encountered in the development of non-profit organizations, it is suggested that non-profit organizations should enrich financing channels and standardize fund management in terms of funds. In terms of human resources, we should pay attention to cultivating employees' leadership and management ability, improving volunteer recruitment and management mechanism; in terms of organization-al operations, it is recommended to develop clear strategic planning, strengthen internal communication and collaboration; in terms of social influence, enhance public awareness and strengthen cooperation and contact with the outside world. The optimization measures will help non-profit organizations to achieve their mission and develop better.

**Keywords:** Rapid development; Improving volunteer recruitment; Management mechanism

---

## Introduction

Against the backdrop of rapid economic development and inadequate government services, nonprofit organizations have emerged rapidly and played a significant role, growing into an important component of social governance <sup>[1]</sup>. Nonprofit organizations, driven by the goal of promoting social welfare, provide resources and services to society in areas where the government fails, such as education, healthcare, and elderly care, contributing to social construction and sustainable development.

However, compared to developed countries, the nonprofit sector in China is still immature, facing issues such as limited funding sources, talent shortage, and governance structure confusion. In recent years, negative news related to nonprofit organizations has emerged frequently, drawing attention from various sectors of society. How to better fulfill their mission and promote sustainable development <sup>[2]</sup> has become a key concern in nonprofit organization management.

## 1. Problems faced by non-profit organizations in their development

### 1.1 Financial resource issues

Non-profit organizations have a single and low utilization rate of financial resources. On one hand, they heavily rely on government subsidies and social donations to obtain funds. However, with limited government subsidies and policy benefits, relying solely on donations from businesses or individuals restricts the development of non-profit organizations. Once the sources decrease or are interrupted, it will have a negative impact on the financial stability of the organization. Additionally, some non-profit organizations are not actively seeking donors and passively rely on fundraising. For newly established or small-scale organizations, it is often difficult to attract donations due to lack of reputation and influence. Lastly, some non-profit organizations fail to fully utilize the funds raised and instead keep them idle in banks.

### 1.2 Human Resources Issues

Firstly, non-profit organizations lack professional talents. In these organizations, there is often a shortage of professionals who can handle multiple tasks, which hampers operational efficiency and limits the growth of the organization and the progress of projects. Additionally, there is a lack of talent incentive mechanisms. There is a misconception that staff in non-profit organizations should provide their services for free or at a low salary. However, this viewpoint does not align with the theory of needs. Staff members need to meet their physiological needs in order to better contribute their value. Furthermore, most employees in non-profit organizations lack professional training, which hinders

their work efficiency and effectiveness in achieving desired goals <sup>[3]</sup>.

### **1.3 Organizational Operational Issues**

Non-profit organizations often lack market research, long-term strategic planning, and development goals, resulting in inconsistent decision-making and inefficient resource allocation. For example, museums and cultural institutions tend to maintain their original state after establishment, rarely engaging with their customers or understanding their changing needs. The long-standing display models reduce their attractiveness to consumers, making it difficult for them to effectively respond to external environmental changes and adversely affecting their long-term development.

## **2. Optimization measures for the sustainable development of non-profit organizations**

### **2.1 Solutions for Financial Issues in Nonprofit Organizations**

Nonprofit organizations should diversify their financing methods, expand their sources of funding, and achieve self-sustainability. They can raise funds through project fees, donations, direct financing and investments, as well as collaborations with funds and trusts to preserve and increase their capital. When seeking financing from the public, nonprofit organizations should enhance the standardization and transparency of their project operations and finances <sup>[6]</sup>. They should also organize gratitude events for donors, establish continuous communication, and build long-term relationships in order to meet the needs and preferences of different donors. By making donors feel valued and important, nonprofit organizations can increase their involvement and support from both current and potential donors.

### **2.2 Solving Human Resources Issues**

Firstly, non-profit organizations and government departments should collaborate to establish talent development mechanisms. This can be achieved by setting up specialized programs and formulating training plans to cultivate talents with relevant academic backgrounds, professional knowledge, and skills. Secondly, it is important to establish a standardized mechanism for volunteer recruitment and management. Recognizing and rewarding outstanding or high-performing talents with material or honorary incentives can attract and retain excellent volunteers, thereby enhancing the organization's execution and influence. Providing training and development opportunities can also improve the capabilities and career development prospects of employees. Lastly, establishing mechanisms for employee participation and communication is crucial. Fully listening to employees' opinions and suggestions can foster a positive work environment and enhance organizational effectiveness.

### **2.3 Addressing Organizational Operational Issues**

Non-profit organizations should formulate long-term strategic plans based on market research. These plans should clearly define the organization's vision, mission, and goals to guide decision-making and resource allocation. This ensures that the organization maintains direction and coherence during its development process.

## **3. Conclusion**

Non-profit organizations face common challenges in their development process. Firstly, funding is a universally existing challenge. Many non-profit organizations rely on limited sources of funding, leading to operational difficulties and constrained development. Secondly, a lack of effective leadership and management skills among the management team, as well as the inadequacy of volunteer recruitment and management mechanisms, pose difficulties in the organization's operations and project implementation. Additionally, internal communication and collaboration challenges, as well as unclear strategic planning, affect the organization's operations and development. Lastly, the social impact of non-profit organizations is sometimes limited, with a lack of public awareness and cooperation and support.

In response to these issues, this paper proposes several optimization measures. In terms of funding, nonprofit organizations should diversify their fundraising channels, explore more funding sources, and establish standardized financial management practices. In terms of human resources, organizations should focus on cultivating leadership and management abilities among their staff, and establish a robust

mechanism for volunteer recruitment and management. In terms of organizational operations, clear strategic planning should be established, internal communication and collaboration should be strengthened to enhance organizational efficiency and effectiveness. To address the issue of social impact, nonprofit organizations should enhance public awareness and establish cooperative and supportive relationships with relevant stakeholders.

## References

- [1] Sun, B., & Wang, Y. (2023). Breaking the “Presumption”: How to optimize and enhance the interaction between government and non-profit organizations - Path suggestions based on signal theory. *New Horizon*, 04, 89-96.
- [2] Ma, Q., & Zhang, L. (2022). How the government supports the internationalization development of non-profit organizations: An analysis based on samples from five countries. *Chinese Public Administration*, 10, 109-117. DOI: 10.19735/j.issn.1006-0863.2022.10.12.
- [3] B., A., R., H-G., & B., M. A. (2023). Addressing social-business tensions in hybridized nonprofit organizations: The contribution of strategic human resource management. *Human Resource Management Review*, 33(4).
- [4] Hua, R. (2021). Political Label and Selective Information Disclosure: Evidence from Charity Foundations in China. *VOLUNTAS: International Journal of Voluntary and Nonprofit Organizations*, 32(2).
- [5] Yang, H., & Li, L. (2021). Commercialization of non-profit organizations: A study on the social enterprise development of social work agencies. *Social Work and Management*, 21(05), 14-24.
- [6] Jiang, P., & Liu, H. (2016). Analysis of the operating mechanism of social work agencies under the CORPS model: A case study of L Organization in Beijing. In *Decision and Information* (pp. 111-114). [Publisher unknown].
- [7] R., A. B., E., S. E., & E., C. (2023). The role of leadership perceptions in performance appraisal participation. *Management Research Review*, 46(9).
- [8] Zhang, H., & Zhang, X. (2016). Innovation and implications of the regulatory mechanism for non-profit organizations in Japan. *Foreign Social Sciences*, 02, 28-34.

## Author’s Bio:

Li Doudou, female, born in 1999, currently a part-time master’s student at the School of Economics and Management, Zhejiang Agricultural and Forestry University. Her research focus is on financial management.

Li Wenchuan, male, born in 1966, holds a master’s degree and is a professor. His research focus is on enterprise management.

# Significance, Challenge and Opportunity of Volunteer Participating in Museum Education

Qing Wang<sup>1</sup>, Chuanyan Cao<sup>2</sup>

1. Wuxi Wu Culture Site and Cultural Relics Protection Center, Wuxi 214000, China.

2. Runshuo Kindergarten in Xinwu District, Wuxi 214000, China.

---

**Abstract:** This paper aims to explore the significance, challenges and opportunities of volunteer participation in museum education activities. First of all, the paper analyzes the significance of volunteer participation in museum education, including enriching educational resources, enhancing audience experience, promoting social participation, promoting cultural heritage, and promoting personal development. Secondly, the paper points out the challenges, including the average age of museum volunteers is relatively high, the uneven level of museum volunteers, the imperfect management system, the lack of volunteer training, the lack of incentive mechanism for volunteers, and the difficulty in evaluating the effectiveness of volunteer services. Then, it puts forward two development opportunities: the application of digital technology in volunteer management and the potential of interdisciplinary cooperation and innovation in volunteer training and development. Finally, some suggestions are put forward from the perspectives of raising awareness, optimizing process, establishing mechanism and strengthening cooperation.

**Keywords:** Museums; Educational activities; Volunteers

---

As the guardian of human cultural heritage, museums play an important role in inheriting history and carrying forward culture. Nowadays, more and more attention has been paid to the function of museum education. As an important force in museum education, volunteers play a positive role in promoting the development of museum cause. This paper will probe into the significance, challenge and opportunity of volunteer's participation in museum education in order to provide beneficial reference for the sustainable development of museum cause.

## 1. Significance of volunteer participation in museum education activities

The aim of educational activities is to promote people's all-round development and social progress through various educational means. Museum education is a kind of public welfare activity, which takes museum as the carrier and disseminates knowledge, culture and values to the public through various forms of education.

The museum education activity forms are various, including exhibition, explanation, guide, interactive experience, educational curriculum and so on. Among them, the exhibition is the basis of museum education activities, through the display of cultural relics, pictures, models and other physical information, to transfer history, culture, art and other knowledge. Explanation and guide is to help the audience to understand the exhibition better through professional explanation and guidance. Interactive experience and education curriculum is through a variety of interactive forms, let the audience experience and practice, deepen the understanding of knowledge and memory.

The participation of volunteers in museum education is of great significance to museums, volunteers and the society, which is mainly reflected in the following aspects:

### 1.1 Enrich educational resources.

The participation of volunteers provides rich human resources for museums. They can help explain, organize activities and provide guided tours. It not only alleviates the shortage of staff in museums, but also brings a variety of experiences and skills to museums and enhances their team strength. Volunteers who can translate foreign languages may assist museums to translate foreign languages; school teachers' volunteers may promote museums' educational activities to meet educational requirements; volunteers with different backgrounds of geography, biology, physics, chemistry and other disciplines may provide professional support for broadening types of educational activities and enriching educational contents.



## **1.2 Improve audience experience**

Volunteers can enhance the visitors' experience. They can help the museum to carry out various educational activities, such as lectures, workshops, parent-child activities, etc. Their personal experiences and stories can also serve as models and examples for the audience to learn and stimulate the interest and motivation of the audience to learn. Rather than standardised commentary by regular commentators, volunteers offer personalized commentary that can sometimes help viewers better understand and appreciate the exhibits.

## **1.3 Promoting social participation**

The participation of volunteers helps to promote social participation and cultural exchange. They not only provide services for museums, but also convey the concept and educational value of museums to the society.

## **1.4 Promote cultural heritage**

In the process of museum education, volunteers not only spread knowledge, but also cultural values and cultural heritage, which has a positive effect on cultural heritage and development.

## **1.5 Enhance personal development**

By participating in the volunteer activities of museums, volunteers can improve their personal abilities such as cultural attainments, organizational skills and communication skills.

## **2. Challenges of volunteer participation in museum education activities**

### **2.1 Overall age of museum volunteers is higher than normal**

According to the present situation of museum volunteer service in our country, the age of museum volunteer is generally higher. With the renewal of contemporary educational ideas, museums have gradually become the main places for primary and secondary school students to study and study.

### **2.2 Uneven level of museum volunteers**

At present, museums generally recruit volunteers in a unified way, but the cultural quality of social volunteers varies greatly, and most of the volunteers are not professional.

### **2.3 Imperfect management system**

Museum volunteer management has not yet formed a sound mechanism, the lack of unified management standards and processes, resulting in confusion, affecting volunteer service quality and museum image.

### **2.4 Insufficient volunteer training**

Museum training for volunteers is not systematic and perfect, lack of training programs and courses for different positions and tasks, resulting in uneven service levels and quality of volunteers.

### **2.5 Insufficient incentive mechanism for volunteers**

The incentive mechanism of museums to volunteers is not sound enough, the lack of effective incentives and incentive measures to stimulate the enthusiasm of volunteers and participation.

### **2.6 It is difficult to assess the effectiveness of volunteer services**

It is difficult for museums to evaluate the service effect of volunteers scientifically and objectively, and to evaluate and manage the service quality and contribution of volunteers effectively.

### **3. Development opportunities**

At present, with the social development and scientific and technological progress, the participation of volunteers in museum education activities has ushered in important development opportunities, mainly in the following two aspects:

#### **3.1 Application of digital technology in volunteer management**

The application of digital technology in volunteer management is mainly as follows:

3.1.1 Online recruitment and registration: through the establishment of a digital volunteer management system, museums can achieve online recruitment, online registration, online review and other functions to improve recruitment efficiency and accuracy.

3.1.2 Information management and update: the digital technology can realize the centralized management of volunteer information, including personal information, service records, training records, etc., and facilitate the management and service arrangement of volunteers.

3.1.3 Online training and education: through digital technology, museums can provide online training and education courses to facilitate volunteers to learn relevant knowledge at any time and any place, and improve service quality and level.

3.1.4 Task allocation and scheduling: The digital technology can realize the task allocation and scheduling for volunteers, and reasonably allocate service posts and work tasks according to volunteers' specialties and time arrangements.

3.1.5 Service effect evaluation and feedback: Digital technology may, through the establishment of an evaluation system, objectively evaluate and give feedback on the service quality and effect of volunteers, so as to help volunteers discover problems and deficiencies and improve service quality.

3.1.6 Data analysis and decision support: Digital technology can analyze and mine volunteer data, provide support for decision-making of museums, and help museums better manage and develop volunteer teams.

#### **3.2 Potential of interdisciplinary cooperation and innovation in volunteer training and development**

The potentials of interdisciplinary cooperation and innovation in volunteer training and development are as follows:

3.2.1 Integration of multiple knowledge systems. Interdisciplinary collaboration can integrate knowledge and methods from different fields, such as history, art, education, psychology and so on, thus providing volunteers with more comprehensive and in-depth training. This diverse body of knowledge can help volunteers better understand and convey museum exhibits and information.

3.2.2 Exploration of innovative training methods. Combining the theory and practice of different disciplines, we can develop more innovative and attractive training methods. For example, the use of pedagogy in the context of teaching methods, role play, or the introduction of virtual reality, augmented reality and other advanced technology to provide volunteers with immersive training experience.

3.2.3 Improve the comprehensive quality of volunteers. Interdisciplinary cooperation can not only improve the level of volunteers' professional knowledge, but also cultivate their interdisciplinary thinking and comprehensive quality. For example, by participating in interdisciplinary projects, volunteers can learn skills such as teamwork, innovative thinking, and cross-cultural communication, which are important for their personal development and social participation.

3.2.4 Expand the service scope of volunteers. Interdisciplinary collaboration can provide volunteers with more diverse service areas and opportunities. For example, combined with sociology, anthropology and other research methods, volunteers can participate in community cultural research, oral history, so as to expand its service content and influence.

3.2.5 Promoting the innovative development of museum education. Interdisciplinary cooperation and innovation can not only improve the quality and ability of volunteers, but also promote the overall innovation of museum education activities. By introducing new educational concepts and methods, museums can develop more attractive and influential educational programs to enhance public awareness and interest in museums.

To sum up, interdisciplinary cooperation and innovation have great potential in the training and development of museum volunteers. Museums should actively seek cooperation with different disciplines to explore and innovate the methods and contents of volunteer training so as to promote the common development of museum education and volunteer service.

## **4. Suggestions**

### **4.1 Raise the awareness and motivation of volunteers participating in museum education**

4.1.1 Carry out volunteer awareness education activities: organize volunteer awareness training courses on a regular basis, and enhance volunteers' understanding of the value of museum education and their enthusiasm for participation through explanation, case analysis, experience sharing, etc.

4.1.2 Setting up volunteer role models: Select and commend excellent volunteers in museum education services, and encourage more people to actively participate through their role models.

### **4.2 Optimize the recruitment, training and management process of volunteers**

4.2.1 Broaden recruitment channels: release recruitment information through multiple online and offline channels to attract more volunteers with willingness and ability to participate.

4.2.2 Standardized training: develop a unified training program and teaching materials to ensure that volunteers receive systematic and comprehensive training and improve service quality and effect.

4.2.3 Improve the management process: establish a volunteer information management system to realize the unified management of volunteer registration, training, service records and other information and improve the management efficiency.

### **4.3 Establish an effective incentive mechanism and evaluation system for volunteers**

4.3.1 Incentive mechanism: a reward system for volunteers shall be established to give material and spiritual rewards to the volunteers who have performed well in museum education services, and to stimulate their enthusiasm and sense of honor.

4.3.2 Evaluation system: a scientific evaluation system shall be established to evaluate the service effects of volunteers on a regular basis, provide timely feedback and guidance, and help volunteers improve and enhance their services.

### **4.4 Strengthening cross-departmental and cross-field cooperation and resource integration**

4.4.1 Cross-departmental cooperation: establish close cooperation with other departments within the museum to jointly plan and implement museum educational activities and improve the overall effect of the project. Such as archaeology, cultural relics preservation and other departments to participate in cooperation, can enhance the scope and depth of museum education activities.

4.4.2 Cross-field cooperation: establish cooperative relations with relevant institutions and experts in other fields, introduce new educational concepts and methods, and enrich the contents and forms of museum educational activities. In particular, strengthen cooperation with schools to jointly carry out educational projects and activities. By working with schools, museums can better understand the needs and characteristics of students and provide more targeted training and support to volunteers.

4.4.3 Resources integration: make full use of various resources inside and outside museums, including manpower, material resources and financial resources, to provide better training and support for volunteers and promote the development of museum education. For example, professionals can be invited to give lectures to volunteers, organize volunteer sharing sessions, and carry out volunteer visits.

## **5. Conclusion**

With the increasing attention to cultural education, the number and enthusiasm of volunteers participating in museum education will continue to grow. With the integration of advanced technical means and the emphasis on "people", future museum education activities will pay more attention to diversified and personalized service needs. While promoting the innovative application of digital technology, museums should also pay attention to volunteer experience and feedback, as well as their rights and welfare. Of course, whether now or in the future, the premise for museums to carry out all work is the safety and protection of cultural relics. Protection first "is the primary task in the policy of cultural relics work in the new era."

## References

- [1] Christy Van Hoffen, Ronnie Wellman. Recruiting and Management Volunteers - Museum Volunteer Management Handbook [M]. Shanghai Science and Technology Education Press, 2016.
- [2] Ma Liwei. Museum Volunteer Education [M]. People's Press, 2019.
- [3] Chen Zenglu. The Present and Future of the Museum's Microrevolution: Museum Volunteers [J]. Chinese Museum, 2012 (03).
- [4] Wu Xin. Research on the detailed management of volunteers in the free opening of museums [J]. Journal of the National Museum of China, 2019 (01).

About the author: Wang Qing (1982-), male, Han nationality, Changzhou, Jiangsu, Wuxi Wu Culture Site and Cultural Relics Protection Center, associate researcher, cultural relics protection and museum education.

Cao Chuanyan (1988-), female, Han nationality, Pizhou, Jiangsu, Runshuo Kindergarten in Xinwu District, second-level teacher, pre-school education.

# Application of Blockchain Technology in Emergency Supply Chains

Guanwei Huang , Xingying Wang

School of Economics and Management, Tongji University, Shanghai 200092, China.

---

**Abstract:** COVID-19 has brought great challenges to the world. As an important part of emergency supplies support, the information sharing level of the Emergency Supply Chain(ESC) plays an important role in its rapid response capability. Firstly, this paper analyzes some problems existing in China's ESC during the epidemic. Then, the emergency supply chain is divided into four stages. Finally, the paper conducts a coupled analysis of the problems within each phase and the integration of blockchain technology. In conclusion, the application of blockchain technology can realize information transparency, which could improve China's ability to supply emergency supplies under public health emergencies.

**Keywords:** Emergency Supply Chain; COVID-19; Blockchain; Information Sharing

---

## 1. Introduction

The COVID-19 pandemic emerged in China at the end of December 2019 and erupted globally in 2020<sup>[1]</sup>. The assurance of emergency medical supplies is fundamental to logistical support for frontline medical forces, with the Emergency Supply Chain(ESC) representing a crucial link in securing these supplies. This significance was particularly highlighted during this unprecedented global health crisis<sup>[2]</sup>. The ESC during this pandemic exhibited characteristics of multiple participating entities, strong systemic requirements, intricate processes, extensive frontline operations, widespread geographical coverage, and close interlinking of various stages. However, the lack of transparency, asymmetry, and non-disclosure of information at different stages became the primary issues within the ESC, resulting in mismatches between supply and demand, delayed responses, and untraceable donated supplies<sup>[3]</sup>. Despite efforts by governmental bodies to coordinate multiple resources to ensure the supply of emergency materials<sup>[4]</sup>, the lack of swift establishment of a collaborative mechanism within the ESC persisted, leading to issues of non-transparency and hampering the response speed of the ESC.

Blockchain technology, characterized by its decentralized, tamper-proof, and transparent nature, offers a secure and efficient solution for information sharing<sup>[5]</sup>. Presently, blockchain applications span various domains such as financial services, big data services, and the Internet of Things. This paper, through a thorough analysis of the actual impact of the COVID-19 pandemic on the ESC and its existing problems, coupled with an analysis of the characteristics of blockchain technology, aims to ensure the public disclosure, transparency, and immutability of supply and demand data after public health incidents. The goal is to achieve supply chain traceability for emergency supplies, enhance the response speed of the ESC, and ensure the rational allocation of emergency materials.

## 2. Problems in the Emergency Supply Chain

### 2.1 Inaccurate Emergency Supplies Demand

During the COVID-19 outbreak, shortages in emergency supplies arose due to insufficient local reserves to match the rapid spread of the virus. The unpredictability of the outbreak's duration and scope increased uncertainty in estimating emergency supply needs, causing significant discrepancies between estimated and actual demands. This inaccuracy hindered decision-making for supply procurement and allocation, challenging the central coordination of emergency supplies.

### 2.2 Unreasonable Procurement Plans

Panic caused by the pandemic led to mismatches between supply and demand, prompting urgent and excessive procurement of emergency supplies in various regions. This rush led to hoarding even in less affected areas, complicating supply distribution to severely affected

regions. Lack of transparent demand information, delayed monitoring, and information dissemination contributed to these challenges.

### **2.3 Non-disclosure of Available Emergency Stock**

The lack of comprehensive national emergency supply information made it hard to prioritize supplies based on epidemic severity. Regional governments hesitated to share available stock, leading to gaming behaviors among regions and difficulties in efficiently distributing supplies to high-risk areas, despite later central government supervision.

### **2.4 Opacity in the Allocation and Direction of Donated Supplies**

Amidst the outbreak, donations poured in, but logistical issues emerged. Donated supplies often didn't meet medical standards and faced allocation chaos and unclear destinations. Existing platforms for donation information lacked scale and comprehensive functionality.

### **2.5 Delayed Information Sharing**

Delays in emergency supplies reaching regions due to procurement, shipment, and transportation timeframes caused ineffective regulation and resource wastage, increasing logistics and storage costs.

### **2.6 Information Asymmetry Between Supply and Demand Parties**

China's lack of a real-time platform for crucial emergency supply-demand data led to delayed updates on demand information. This delay caused surplus supplies due to production delays in reducing output, incurring substantial storage costs and wastage.

### **2.7 Incomplete and Insecure of the Existing Emergency Supplies System**

Existing systems lacked efficient interdepartmental and interregional information sharing. These top-down managed systems operated independently from demand information, hindering supply-demand matching. Additionally, storing most information in main nodes posed risks of information loss due to node issues or cyberattacks.

## **3. Coupling Analysis with Blockchain Technology**

This paper defines the ESC as a demand-driven dynamic supply-demand network established for rapid response and delivery of emergency materials in an epidemic environment caused by the spread of viruses or bacteria with the core objectives of rapid treatment implementation and early prevention and control. The ESC is divided into four phases: procurement planning, material supply, distribution, and material reception. After the outbreak, based on information released by the National Health Commission regarding epidemic levels, infection numbers, and material reserves, rapid responses were initiated for material procurement. The central government and relevant institutions engaged in procurement, production, and reasonable allocation of emergency materials. The distribution center facilitated supply-demand matching, ensuring timely delivery of these emergency materials to the required regions. Subsequent responses were adjusted based on the epidemic level, infection numbers, and updated demand in the recipient regions, creating a dynamic process for emergency material allocation. Information sharing plays a pivotal role in coordinating supply chain businesses, forming an integral part of business coordination. Despite partial reliance on information management systems like ERP in the current ESC, there remains a lack of comprehensive integration and coordination across all stages. This leads to varying degrees of information asymmetry among entities, escalating coordination costs. Blockchain technology, with its decentralized ledger utilizing encryption, hash algorithms, digital signatures, and consensus mechanisms, addresses this issue. It ensures transparency, data authenticity, and immutability in the ESC, eliminating asymmetry, enabling information sharing, and maintaining data integrity across all stages.

Blockchain's application enhances the ESC's response speed and reliability. It secures data on fund flow, logistics, and information flow in each stage, cutting coordination and management costs. This guarantees the efficient allocation and use of emergency materials. The study conducted a coupling analysis between the issues in the COVID-19 ESC and blockchain technology:

Firstly, a blockchain-based ESC enables real-time sharing of procurement, supply, distribution, and epidemic information. Through information sharing, various participating entities can effectively formulate procurement, scheduling, transportation, and production plans to

match supply and demand, thereby enhancing the utilization of emergency materials. In the later stages of the epidemic, symmetrical supply and demand information will reduce the bullwhip effect. Manufacturers and local governments can timely adjust production and procurement plans to avoid overcapacity and material waste.

Secondly, by applying blockchain, the correctness and integrity of information are ensured. Entities can only add new information within each block of the blockchain, without the ability to modify or delete existing information. This guarantees the reliability of data at each stage of the ESC, making inventory and logistics information immutable, thereby improving the security and reliability of the supply chain.

Thirdly, in cases where information errors or data tampering occur during information sharing in the supply chain, hash function pointers can quickly locate the storage position of erroneous information, enabling data traceability. This helps ensure the reliability of all data related to the movement of emergency materials, avoiding situations where the dynamics of donated materials are unclear.

Fourthly, blockchain's distributed ledger system decentralizes supply chain data storage, spreading it across the blockchain. Accessible by authorized participants, this ensures transparency, enabling coordinated information flow across the ESC. It minimizes information disparities, allowing efficient material allocation and rapid responses. Moreover, this method offers heightened data security compared to traditional databases, enabling data recovery through other nodes in case of a node or block issue

#### **4. Conclusion**

The ESC forms the foundation for ensuring the availability of emergency materials. The sharing and exchange of information among various entities at each stage of this chain facilitate both horizontal and vertical coordination of all information. This integration fosters unified management, providing the fundamental groundwork for coordinated efforts in combating epidemic situations. This paper, through coupling analysis, has demonstrated that the application of blockchain technology in the ESC effectively resolves issues such as information asymmetry, inaccuracies, and delays during information transmission. It ensures that all participating entities in the ESC can access data information in real-time with precision, reducing the impact of the bullwhip effect, accelerating the responsiveness of the ESC, supporting traceable and controllable emergency logistics. Ultimately, it achieves a scientific, efficient, and precise process for the production, procurement, scheduling, and distribution of emergency materials, thereby enhancing the management level of the ESC.

#### **References**

- [1] Wang, J., Cui, Z., Pan, X., & Dong, S. (2020). Simulation of the transmission mechanism and intervention effects of COVID-19 based on a generalized SEIR model. *Science and Technology Review*, 38(22), 9.
- [2] Jia, Y., Zhou, J., & Qiu, J. (2020). Analysis of emergency material management risks and responses during the COVID-19 pandemic. *Chinese Hospitals*, 24(09), 77-79.
- [3] Zhao, Y., & Yang, T. (2021). Research on emergency medical supply chain of novel coronavirus in cloud logistics environment. *Logistics Technology*, 44(3), 123-125. DOI: 10.3969/j.issn.1002-3100.2021.03.032.
- [4] Huo, J., Zhang, J., & Xu, S. (2023). Strategic reserve and rotation analysis of emergency medical supplies: a case study of masks. *Shanghai Management Science*, 45(1), 43-49.

Author's Bio: Wang Xingying (1998--), female, from Xiaoyi City, Shanxi Province, currently pursuing a master's degree. Research focus: Emergency Supply Chain and Logistics Management.

# Prediction of growth trend and application of *Synechococcus* PCC7002 in industrial culture based on MTS-Mixers

Sichao Hu

Hunan University of Science and Technology, Xiangtan 411100, China.

---

**Abstract:** Industrial closed culture of Marine microalgae requires higher environmental parameters in the whole process. *Synechococcus* PCC7002 was selected as the culture object in the pilot stage of the culture, and a variety of parameters in the culture process were collected and a data set was established. A growth prediction model of *synechococcus* PCC7002 based on LSTM neural network was constructed. Multiple environmental parameters, such as temperature, pH, light intensity, air input and dissolved oxygen value, were used as input parameters of the model. After repeated training and learning, turbidity value (i.e., cell concentration) of the growth state of microalgae was obtained. The turbidity value of quantifiable microalgae growth conditions and the growth trend of PCC7002 were obtained after the coupled training of the main environmental factors in the microalgae culture process. Then, the MTS-Mixers algorithm was integrated to predict the external environment prediction curve required for the growth of microalgae in the stable and exponential stages in the culture process.

**Keywords:** LSTM; MTS-Mixers; Industrial training; *Synechococcus* PCC7002

---

## 1. Introduction

With the explosion of population, the problem of food shortage has been difficult to solve effectively by traditional industrial and agricultural means. In recent years, people have turned their research direction to biotechnology, hoping to develop organisms with rich nutrient content and short culture cycle into one of the raw materials for nutrient intake through biotechnology means. Due to the advantages of fast splitting speed, high photosynthetic efficiency and short production cycle, microalgae organisms have shown wide application prospects and huge demand in animal feed and food industry. Among them, *Synechococcus* sp. strain PCC7002 and other algae have the potential to act as nutritive substitute materials due to their high protein, low carbohydrate water and low fat characteristics, which have gradually attracted the attention of scientists.

Microalgae are widely distributed in nature, it is difficult to achieve enrichment, and it is not worth the loss to harvest microalgae raw materials by artificial fishing. The photobioreactor is the core equipment for the industrialization and large-scale cultivation of microalgae. At the same time, the growth process of microalgae can be divided into delayed period, exponential period, stable period and decline period according to the growth characteristics. The lag period is characterized by slow growth of cell number; The exponential stage is characterized by the close relationship between the number of viable bacteria and the total number of bacteria, the shortest generation time of cell division, and the largest growth rate, which is the key stage of microalgae culture. The stable period is characterized by the growth of microalgae has reached the peak, which is the best period to harvest products. The decline stage was characterized by a very low proportion of the live bacteria in the total bacteria number, and a large area of microalgae died. In the whole culture process, the lag period and exponential period have direct influence on the output. When the culture environment is suitable for the growth of microalgae, the lag period is shortened, and the exponential cell generation is shortened and the growth rate is accelerated. According to the growth process of microalgae and the demand of industrial culture, a photobioreactor which can be intelligently controlled was designed to improve the culture efficiency.

With the rapid development of deep learning, some neural networks can predict the trend of data within a certain period of time according to the demand because of their nonlinear fitting and ultra-high training operation ability. Based on Long short-term memory (LSTM) and multiple time series prediction model (MTS-Mixers), this paper predicted and analyzed the cultivation process of polycoccus PCC7002 in the pilot stage, and obtained the optimal curve of various environmental parameters suitable for polycoccus cultivation in this equipment. LSTM is a kind of temporal Recurrent Neural Network, which comes from solving the long-term dependence problem of recurrent neural network (RNN). Compared with RNN, which only has a hidden state  $h_t$ (hidden state), LSTM adds a passing state and a cell state  $c_t$ (cell state) in the



optimization process. It acts as a “processor” to determine whether the information is useful. Adam optimization algorithm effectively solves the problem of gradient descent. In this paper, LSTM can be introduced to solve the problem of predicting the growth trend of microalgae by environmental variables during the culture process. MTS-Mixers is a general framework for multivariate time series prediction proposed by Huawei in 2023. It is not only used to improve the performance of time series prediction by combining attention mechanism, but also to solve the problem of the lack of explanation of attention mechanism in the actual use of Transformer, which is used to capture the long-term correlation of time series prediction. It also solves the problem that the data in the process of acquisition is affected by the sampling frequency and the sensor.

In the process of microalgae culture, a large amount of data will be generated, mainly including the temperature, pH, dissolved oxygen value, light and turbidity of the algae solution in the culture environment, and the turbidity in the reactor. The process environmental parameter database after successful culture of polycoccus can be established, and the model can be trained and established to predict the growth trend of polycoccus with high accuracy. The department confirmed the scientific nature of the culture process with LSTM. However, due to the real-time monitoring and control of the temperature, pH, light intensity and dissolved oxygen value inside the reactor in a wide range during the culture process, the synechococcus is not in the best growth environment at every moment due to its biological characteristics such as growth, division and cell activity. Therefore, the optimization curves of various environmental factors in the stable period and exponential period of polychococcus in the process of polychococcus culture can be predicted by the turbidity change of polychococcus in turn through the fusion of MTS-Mixers.

In view of the above studies, a microalgae growth prediction model was proposed in this paper in combination with the corresponding deep learning framework and the data set of the successful cultivation of PCC7002 synechococcus, and the optimized environmental parameters of the synechococcus in the stable and exponential stages of the culture process were predicted by the changes in the cell concentration of the synechococcus. First, the environmental data of a single successful culture of synechococcus were collected, including temperature, pH, light intensity, air input and dissolved oxygen value, and the culture process was repeated several times to obtain the data set. Secondly, a multivariable temporal recurrent neural network prediction model with five environmental parameters as input parameters was established to predict the growth of synechococcus in the short term. Finally, the fusion MTS-Mixers algorithm predicted the external environment prediction curve of polycoccus in the stable and exponential stages of the culture process through the cell concentration changes, providing technical support for improving the success rate and yield of industrial cultured microalgae products.

## **2. Data and models**

In this study, a microalgae growth prediction model was proposed based on the multi-variable temporal recurrent neural network and the data set of the successful cultivation of PCC7002 in the pilot stage. Five environmental parameters, including temperature, pH, light intensity, dissolved oxygen value and air input, which have major effects on microalgae growth, were taken as input parameters. The turbidity value (i.e., cell concentration) of the growth state of microalgae was used as the output variable. The construction of the model is divided into three stages: (1) data collection; (2) Data preparation and preprocessing; (3) Neural network training.

### **2.1 Strain pre-culture and data collection**

The data set used in this study is the real-time environmental parameters recorded in the reactor during the self-cultured synechococcus PCC7002. Polycoccus was inoculated with BG11 (Rippka, 1988) solid medium plate (1.5% AGAR). When algal colonies appeared on the plate, single algal colonies were selected and inoculated in 50mL liquid BG11 medium (250mL conical bottle). 75  $\mu\text{mol photons m}^{-2}\text{s}^{-1}$  (4000K white light) in 1% (v/v) CO<sub>2</sub> at 37°C.

### **2.2 Data Preparation**

After the strain was placed in a 1L culture bottle for secondary expansion, the algal liquid was poured into a closed tube photobioreactor for further culture, and the growth of the polycoccus was recorded. In order to reduce the complexity of the model, the environmental parameters were divided into elements, and a time series model was established to predict the turbidity value of microalgae. The input variables

suitable for the artificial neural network included the temperature inside the reactor, pH, light intensity, air input and dissolved oxygen value, and the cell concentration at a certain time was defined as the output variable. This dataset converts the time read into a timestamp, and the parameters for this study include five input parameters and one output parameter (Table 1).

Table 1 Input and output parameters of neural network

	temperature	pH	light	air_in	O2	turbidity
count	6012.000000	6012.000000	6012.000000	6012.000000	6012.000000	6012.000000
mean	30.524251	8.129087	102.700432	1.996770	11.777792	312.283081
std	8.772746	0.090406	151.761402	0.015042	6.509991	204.550519
min	17.900000	7.910000	0.000000	1.899100	5.800000	1.130127
25%	23.100000	8.060000	0.000000	1.987200	6.347000	182.438259
50%	29.800000	8.120000	1.000000	1.996400	7.005000	317.564981
75%	36.800000	8.210000	146.000000	2.006000	20.000000	429.218871
max	48.800000	8.400000	501.000000	2.075800	20.000000	806.312219

## 2.3 Neural network training

### 2.3.1 Prediction of growth process of *Polycoccus* by LSTM

LSTM is a multivariable temporal recurrent neural network optimized to alleviate the gradient vanishing and forgetting problems of RNN for excessively long sequences. Its output mode is shown in Figure 1. LSTM adds a passing state in the optimization process. Compared with RNN, which only has a passing state ht(hidden state),LSTM adds a cell state ct(cell state) on this basis. With the increase of ct-1, ct not only changes slowly with the change of c, but ht and ht-1 will show great differences with the rapid change of h.

The internal structure of LSTM is trained by the current input value xt and the ht-1 passed from the previous state value through the network to obtain four states, which are transmitted to the next state through the forget stage, the selection stage and the output stage. In the forget stage, the input from the previous node is selectively forgotten, and the discarded part of ct-1 in the previous state is controlled by the calculated zf. In the select stage, the input information is filtered, the current input content is represented by z calculated in the previous step, and the signal is controlled by zi. The ct transmitted to the next state is obtained by combining the two, namely:

$$c^t = z^f \odot c^{t-1} + z^i \odot z \quad (1)$$

The output phase uses zo to determine the output that will be regarded as the current state, and the output yt is often changed by the transfer state ht:

$$h^t = z^o \odot \tanh(c^t) \quad (2)$$

$$y^t = \sigma(W^o h^t) \quad (3)$$

The neural network model is built by using all parameter training data, and the optimal neural network architecture is obtained by integrating training set, verification set and test set. In this experiment, 5 input parameters temperature, pH, light, air\_in, O2 and 1 output parameter turbidity were used. After data set partitioning and training for several times, the data set was divided into the training set and the verification set in the ratio of 4:1. Adam optimization function was used and the number of prediction steps was set to 200 and the number of iterations was set to 50 to get the corresponding curve. The LSTM algorithm model is shown in Figure 1.

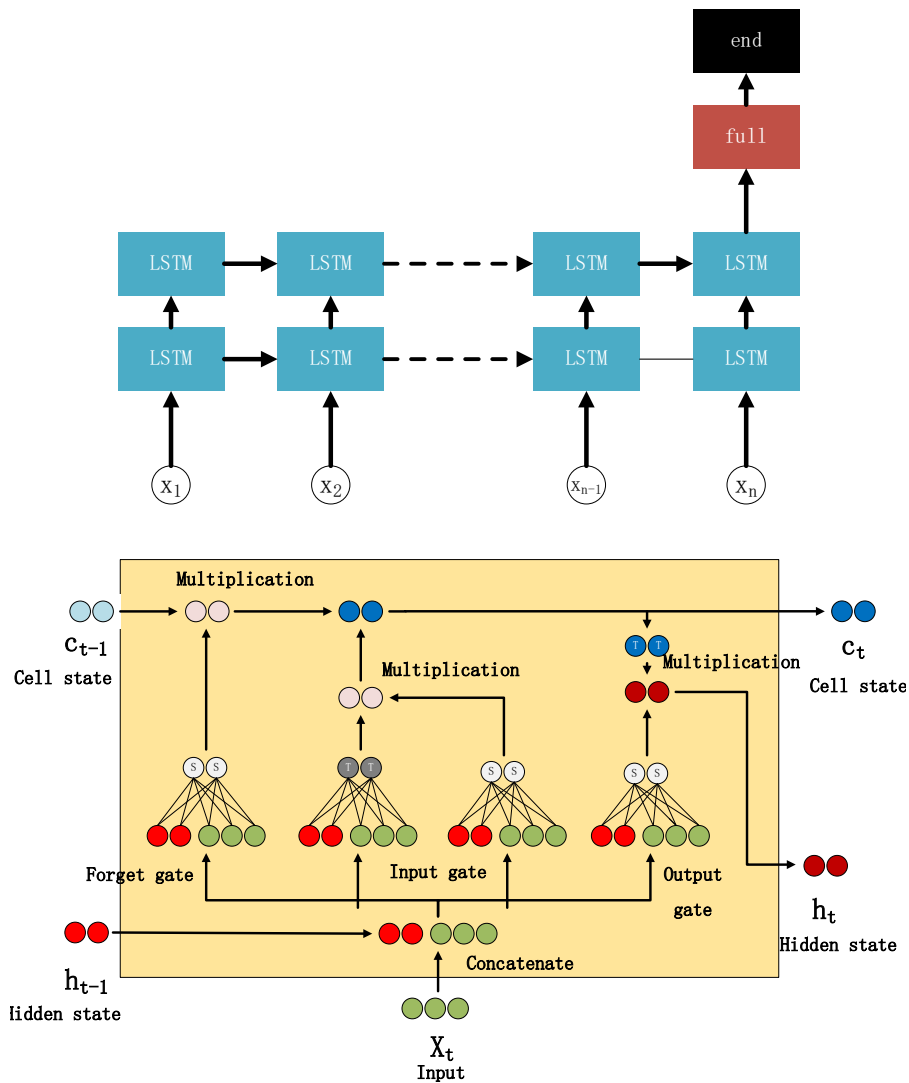

Figure 1 LSTM algorithm structure (top), LSTM internal structure (bottom)

The turbidity prediction of polycoccus was obtained through training, as shown in Figure 2, where the horizontal coordinate is the time stamp and the interval is 1 minute. The ordinate is the turbidity value used to characterize the concentration of synechococcus cells. The left figure is the comparison between the actual value of the trained data set and the predicted value, and the right figure is the comparison between the actual value of the trained test set and the predicted value. After model training and curve comparison, it can be seen that the actual value is highly consistent with the predicted value.

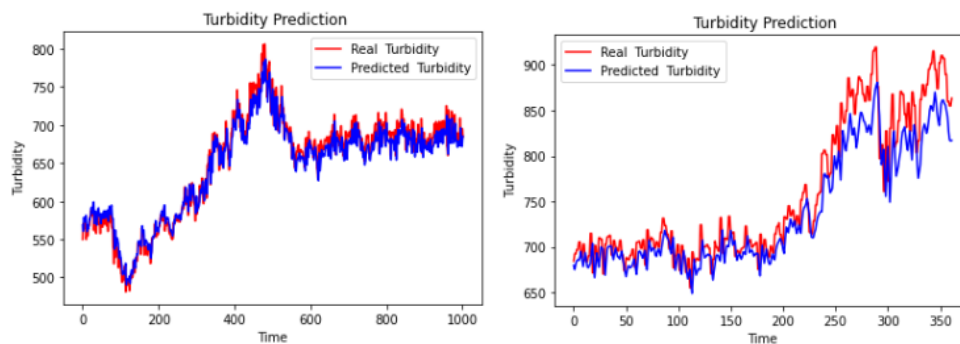

Figure 2 Turbidity prediction

### 2.3.2 Prediction of environmental parameters of synechococcus culture by MTS-Mixers algorithm

On the condition that the prediction curve of the growth trend of polycoccus was highly consistent with the actual value, the rationality of the culture process was confirmed. On this basis, the MTS-Mixers algorithm was integrated to predict various environmental parameters of the culture process. The structure of MTS-Mixers algorithm is shown in Figure 3. In the actual industrial culture process, what has a direct impact on the yield of microalgae is the growth of microalgae in the lag period and exponential period. When the culture environment is suitable for the growth of microalgae, the lag period is shortened, and the exponential cell generation is shortened, and the growth rate is accelerated, and a large number of products can be harvested in a short time through industrial culture means. The hysteresis period and exponential period of synechococcus were analyzed respectively.

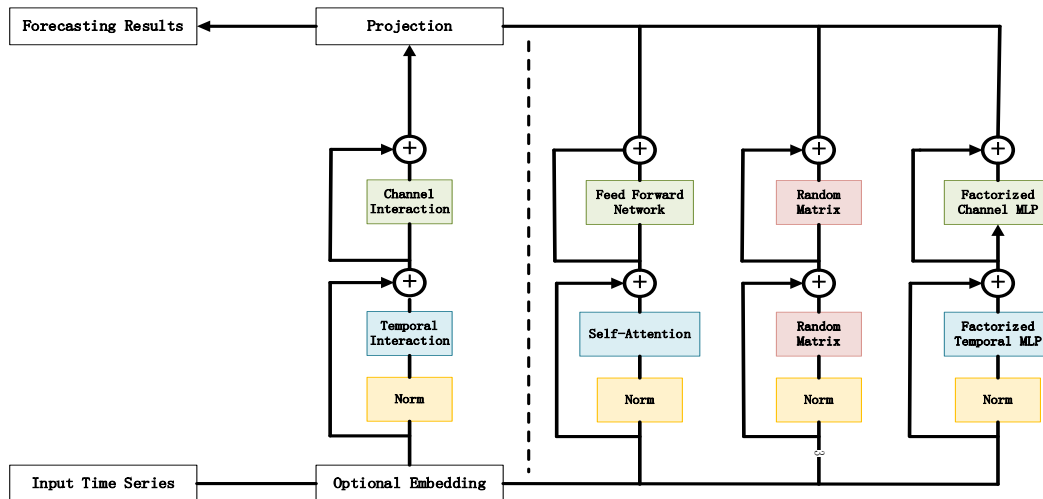

Figure 3 MTS-Mixers algorithm structure

When synechococcus is in the lag period, its growth is determined by the length of time. By excerpting the turbidity changes of synechococcus during the lag period, the optimization curve of the predicted environmental parameters is shown in Figure 4. Where the horizontal coordinate is the time stamp of the delayed period of the synechococcus, and the vertical coordinate is the corresponding eigenvalue.

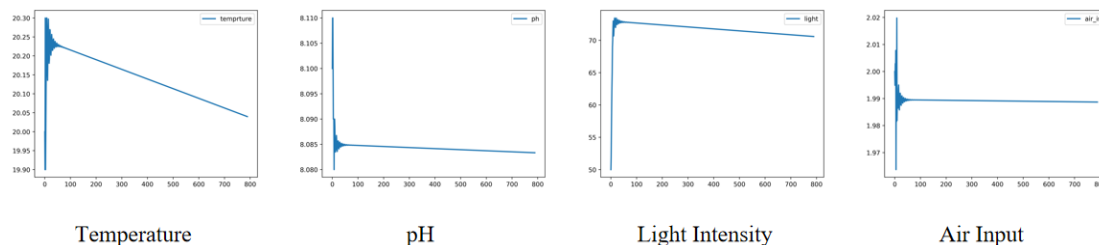

Figure 4 Prediction of environmental parameters of demurrage period

Through the analysis of the predicted data of the lag period, the predicted data fluctuated weakly, which can be approximately regarded as linear changes. As shown in the figure, during the growth process of the lag period, the temperature should be controlled within the range of 20.0-20.2°C, the pH value should be controlled at 8.08, the light intensity should be controlled at 70W/m<sup>2</sup>, and the air input should be controlled at 1.99Ln/m.

When polycoccus is in exponential stage, its growth is determined by multiplication algebra  $n = 3.322(\lg x_2 - \lg x_1)$ , growth rate constant  $R = 3.322(\lg x_2 - \lg x_1) / (t_2 - t_1)$  and generation time  $G = (t_2 - t_1) / 3.322(\lg x_2 - \lg x_1)$ .

By excerpting the turbidity changes of synechococcus in the exponential period, the optimization curve of the predicted environmental parameters is shown in Figure 5. Where the horizontal coordinate is the time stamp of the exponential phase of synechococcus, and the vertical coordinate is the corresponding eigenvalue.

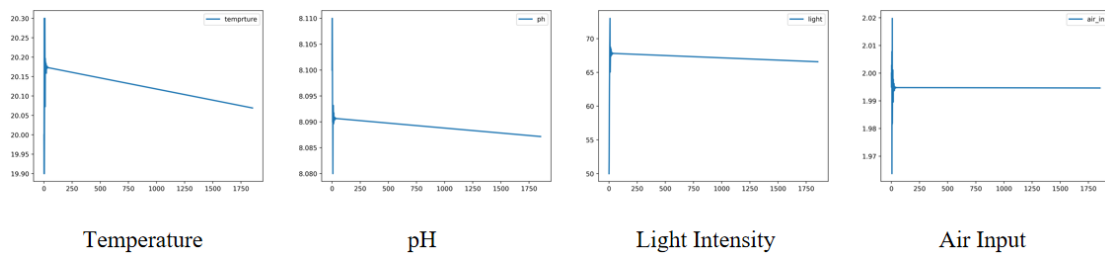

Figure 5 Prediction of environmental parameters in the index period

Through the analysis of the predicted data in the index period, the predicted data has a weak fluctuation range, which can be approximately regarded as linear change. As shown in the figure, during the growth process of the lag period, the temperature should be controlled within the range of 20.0-20.2°C, the pH value should be controlled within the range of 8.08-8.09, and the light intensity should be controlled within 67W/m<sup>2</sup>. air input should be controlled between 1.99-2.00L/n/m.

### 3. Conclusion

The typical growth curve of microorganisms is usually derived by appropriate culture in a laboratory setting and periodic measurement of cell content, with few precedents in pilot stage and industrial production culture environments. In the laboratory environment, the lag time of *Synechococcus* depends on the volume of *Synechococcus*, and the exponential period is between 1.5-2.3 hours. In the process of cultivating *Polycoccus*, the exponential generation time of the equipment is mostly about 1.9 hours, indicating that under the premise of increasing the cultivation capacity in the culture process, the normal growth of *Polycoccus* can be achieved through intelligent control and the high yield of *Polycoccus* raw materials can be obtained through industrial production. In this paper, a large capacity photobioreactor was designed as a vessel for data collection. The fusion LSTM predicted the growth curve of *Polycoccus* by taking environmental factors in the culture process as input parameters, which confirmed the authenticity and scientificity of the data set. The fusion MTS-Mixers predicted the optimization curve of various environmental factors in the culture process through cell concentration in the culture process. For the industrial production of high-value photoorganisms such as *Polychloccoccus*, the situation of large-scale death of organisms caused by poor culture environment during industrial production of photoorganisms was solved, and the technical support was provided for improving the survival rate and yield of photoorganisms.

### References

- [1] Zhilan Chen, Yun Tian, Chenhong Zhu, et al. Sensitive detection of oxidative DNA damage in cyanobacterial cells using supercoiling-sensitive quantitative PCR[J]. *Chemosphere*, 2018, 211: 164-172.
- [2] Ryan L. Clark, Laura L. McGinley, Hugh M. Purdy, et al. Light-optimized growth of cyanobacterial cultures: Growth phases and productivity of biomass and secreted molecules in light-limited batch growth[J]. *Metabolic Engineering*, 2018, 47: 230-242.
- [3] Zhe Li, Zhongwen Rao, Lujia Pan, et al. MTS-Mixers: Multivariate Time Series Forecasting via Factorized Temporal and Channel Mixing[J]. *Machine Learning*, 2023: 1-14.
- [4] Noguchi R, Ahamed T, Rani D S, et al. Artificial neural networks model for estimating growth of polyculture microalgae in an open raceway pond[J]. *Biosystems Engineering*, 2019, 177: 122-129.
- [5] Hochreiter, S, and J. Schmidhuber. "Long short-term memory." *Neural Computation* 9.8(1997):1735-1780.
- [6] Gers F A, Schmidhuber J, Cummins F. Learning to forget: Continual prediction with LSTM[J]. 1999.

# What impact does Covid-19 have on the Fast Fashion Industry(H&M) and Luxury Fashion Industry (Louis Vitton)?

Sixian(Milly) Miao

University of Manchester, United Kingdom, Manchester M1 7FE

---

**Abstract:** This report is going to discuss the impact of Covid-19 on fast fashion industry and luxury fashion industry. In this paper, it will specifically discuss H&M(fast fashion) and Louis Vuitton since they are quite well-known among the public. The research questions are: What is the impact of Covid-19 on both Louis Vuitton and H&M? What are the challenge for both fast-fashion and luxury industries in the context of H&M and Louis Vuitton? What are the potential solutions and strategies for improving the current situation and future trends faced by H&M and Louis Vuitton? The paper uses a mix of qualitative and quantitative method. For the first research question, the paper uses a quantitative method to demonstrate the revenue changes of both companies because of the pandemic. After that, it uses qualitative method by a questionnaire. All the participants are the staff from H&M and Louis Vuitton. For the final research question, the report uses a qualitative method. It asks participants on what can both company do to recover from the pandemic. It also uses academic resources to find out others' thought on improvements. It is suggested that H&M should focus on online store and Louis Vuitton should pay more attention to marketing innovation by launching new collections to attract more customers. It should also focus on online purchase and ensure a on time delivery. It is also suggested that Louis Vuitton should also build a good brand image by engaging with customers.

**Keywords:** Covid-19; Fast fashion; Luxuries; Revenue; Share/stock price

---

## Introduction

The outbreak of Covid-19 at the end of 2019 became a huge event globally. Many countries had to start lockdown and staying-home strategies, which became necessary to control the spread of the disease (Sintema, 2020).<sup>[1]</sup> Even though these measures effectively control the pandemic, they still have a negative impact on society. Furthermore, the negative impact of Covid-19 on society was also enormous. More specifically, it directly affect because of the pandemic, many stores and restaurants had to close according to government policy, and they can not get their income due to the lockdown. As a result, a great number of workers might face unemployment and even lose their jobs due to the pandemic(Douglas, 2020). The pandemic has led to financial losses for many fashion brands, especially for those who rely heavily on physical sales. This article will focus on the fashion industry, specifically H&M(fast fashion) and Louis Vuitton(Luxury). This paper seeks to investigate whether the pandemic has had an impact on different types of fashion industries while H&M and Louis Vuitton are representative of fast fashion and luxury brand.

## 1. Literature Review

It will use both qualitative and quantitative methods including demonstrating the numerical figures to represent any profit changes during Covid-19 and producing several questionnaires to ask for staff or peers opinions. The result of the quantitative method will be illustrated through excel or line graph while questionnaires will be generated through some website links. Furthermore, this paper will also investigate the challenges that H&M and Louis Vuitton have to face and provide some solutions based on experts' opinions. According to the report for 2020, H&M generated global sales of 22.48 billion (Sato, 2020). Meanwhile, according to white and Aloisi, In 2020, Louis Vuitton's sales declined by 17% compared to the previous year, as the company was forced to close many of its stores and delay the launch of new products. However, the e-commerce sales of Louis Vuitton raised significantly during the pandemic in May and June, since more customers start their online shopping(White and Aloisi, 2020). However, these two industries also come up with some strategies to recover from the impact of Covid-19. Some of them tried to connect with customers and try to use some marketing strategies to advertise their goods and gradually changed their selling strategies (Ansari & Ganjoo, 2020).

## 2. Research Question

### 2.1 Research Questions

- (1) What is the impact of Covid-19 on both Louis Vuitton and H&M?
- (2) What are the challenge for both fast-fashion and luxury industries in the context of H&M and Louis Vuitton?
- (3) What are the potential solutions and strategies for improving the current situation and future trends faced by H&M and Louis Vuitton?

### 2.2 Population and sampling

For the questionnaire, there are two for each question since each question needs one questionnaire. Only research question two and three need questionnaire. There are 40 participants for H&M among two stores in Manchester and 19 participants from Louis Vuitton from London and Manchester. In the first research question, H&M participants need to answer closed questions while Louis Vuitton participants need to answer a open question. The result will be demonstrated through a pie chart In the second question(RQ3), all participants will be asked to choose a optimal choice from the closed question. The result will be illustrated through pie charts.

## 3. Results

### 3.1 Data Analysis

Explanation: the sales of H&M experienced a decrease because of Covid-19 from around 24,000 million dollars to approximately 19,600 million dollars from 2015 to 2021.

Explanation: Revenue of Louis Vuitton decreased during the Covid-19(2019-2020) but then increased significantly during the next year(\$75,000millions).

Explanation: The chart above shows Louis Vuitton's revenues in five different groups from 2021-2022 which is during the pandemic. All of them increased.

## 4. Discussion

Nearly 50% of the H&M staff believe that financial losses are the biggest impact of the pandemic for H&M(Figure 3). According to figure1, H&M kept going upwards until 2019, which reflects that it is quite popular before the outbreak of Covid-19. In 2017, H&M's sales peaked, which is 27696.63 million in US dollar. Although H&M's sales have fluctuated slightly, it still remain around 20,000 million until 2019. However, during 2019, the revenue significantly dropped. It decreased from 22,321.2 in 2019 to 19,736.3. Although it recovered by 2021, revenues did not increased very much. Situation in Louis Vuitton was somewhat better than H&M. According to the participants, most of their shops in the UK are temporarily closed in early 2020, leading to a lower revenue in 2020. The revenue decreased from \$60,000 million in 2019 to around \$52,000 million in 2020(Figure 2, Figure 3). Unlike H&M, revenue of Louis Vuitton did not take as big a loss as H&M. In 2021 their revenues rose straight to \$75,000 million, an increase of 30%.

Most of the H&M participants think that the most significant impact of Covid-19 is financial loss which comprise of 48%. Moreover, 15% believe that it has reduced the demand for H&M purchases and 12% believe that the pandemic has disrupted H&M's supply chain. A small minority of 5% believe that the impact of the pandemic has been a shift from offline to online sales(figure 3). The results are similar at Louis Vuitton. According to the appendix, Louis Vuitton closed some of its offline shops, so their revenue was also affected. Louis Vuitton employees also mentioned employment issues, but said they continued to pay their staff during the temporary closures. However, although it is mentioned in literature review that Louis Vuitton experienced a 17% decrease in revenue.

To recover from the pandemic, Zhao suggests that Louis Vuitton should increases its brand affinity through cause marketing and gain numerous benefits by donating money to the social organization. LV stated on 17 out of 40 people think H&M should focus more on online sales since more people go shopping online more frequently. They think H&M should invest in improving its e-commerce platform. 25% of them think H&M should develop local manufacturing to prevent production delays since many of the suppliers were forced to shut down or

reduce production due to lockdown. On the other hand, Louis Vuitton staff do not think online shopping is a good way because it might reduce or lose the uniqueness. Almost half of LV participants think that the best solution is innovation.

## 5. Conclusion

In conclusion, the impact of Covid-19 on Louis Vuitton and H&M was significant and quite similar. Firstly, the financial losses is the most obvious for H&M while Louis Vuitton was able to recover from its financial losses more quickly. Furthermore, according to the Louis Vuitton's staff, H&M's staff and Thomas, they both recognize unemployment as one of the major impacts of Covid-19. They both think the pandemic has disrupted the supply chain of their company. suppliers were forced to shut down or reduce production during the early months of the pandemic due to lockdown and restrictions on movement. Besides, Pandemic has changed the way that H&M sells, customers also change their shopping style. they are used to making online purchases, which introduces a new way of shopping. In addition, all participants gave their opinion on how the company should recover. Even though they might think of different solutions to recover, both of them mention sustainability, which demonstrates that sustainability is important in business. It is suggested that H&M should focus on online sales. As a fast fashion brand, more customers find it more convenient to buy online. As a result, H&M should focus on investing in online platforms. For Louis Vuitton, it is suggested that they should focus on innovation such as launching new collections to attract more customers. They also need to enhance their services, such as on time delivery services. They also need to enhance their interaction with consumers, such as sending them wishes on festivals regularly and ask them for suggestions on the brand, which can be efficient for expanding brand awareness and retaining some customers.

## References

- [1] Sintema, E. J. (2020). Effect of COVID-19 on the Performance of Grade 12 Students: Implications for STEM Education. *Eurasia Journal of Mathematics, Science and Technology Education*, 16(7). [https://www.ejmste.com/article/effect-of-covid-19-on-the-performance-of-grade-12-students-implications-for-stem-education-7893?utm\\_source=summari](https://www.ejmste.com/article/effect-of-covid-19-on-the-performance-of-grade-12-students-implications-for-stem-education-7893?utm_source=summari).
- [2] Adegeest, D. (2021). Fast fashion retailers are closing their stores, shrinking global retail. *Fashion*.
- [3] United, from <https://fashionunited.uk/news/retail/fast-fashion-retaille>.



# The Problems and Countermeasures of Family Doctor Service in China

Yidi Xu

Qufu normal university, Rizhao 276800, China.

---

**Abstract:** In response to the persistent problems of “difficult and expensive medical treatment” in China, family doctor contract based services and related policies have become important content in deepening medical reform and promoting graded diagnosis and treatment in recent years. Existing research is mostly based on developed large cities, mainly analyzing the static and dynamic aspects of policy implementation subjectively and objectively, However, there is less attention paid to the problems of collaborative cooperation between grassroots governments and other governance entities in third tier cities with lower levels of development. This study indicates that there are still problems with the management model of family doctors, such as “signing but not signing”, poor funding and referral between superiors and subordinates. It is necessary to further strengthen the vertical and horizontal linkage mechanism, expand the number of family doctors and enhance their professional attractiveness, and strengthen publicity to create a good social environment for the implementation of the family doctor service model, so as to further promote and sustainably develop the system.

**Keywords:** Family doctor service; The issues and countermeasures; Community health service

---

## Introduction

In order to implement the Party’s policy on health and wellness work in the new era, establish and improve the contract guarantee system for family doctors, and form a work mechanism led by the government, coordinated by departments, with grassroots medical and health institutions as platforms, and various social resources participating. The service management model adopts a family service team, consisting of a “2+X” model consisting of a general practitioner or practicing (assistant) physician at a community health service center (community health service station), a practicing nurse, a public health physician, and experts from a higher-level contracted hospital. They accept outpatient appointments from patients and come to the contracted residents and key populations for treatment.<sup>[3]</sup>

## Literature Review

The family doctor system plays a crucial role in promoting the construction of a graded diagnosis and treatment system, deepening the reform of payment methods, optimizing the allocation of medical and health resources, and promoting convenient access to basic medical services.<sup>[4]</sup>The research on family doctor signing services can be mainly divided into two levels: Firstly, the implementation of family doctor services has important practical significance for improving the quality and level of medical services for residents and improving the quality of building a healthy China. The signing of community family doctor contracts significantly reduces the medical expenses of the elderly, promotes graded diagnosis and treatment, optimizes the allocation of data resources, and has a significant impact on improving the health level and accessibility of medical services for the elderly (Li Lele, Li Yixuan, Chen Xiangyu, Gao Jianzhe, Wei Donghao, 2022). Based on the empirical analysis of mobile recognition test data in Guangzhou, Taiyuan, and Chongqing in 2018, it was found that family doctors are conducive to promoting the equalization of basic public services and the realization of urbanization (Liang Tukun, 2022).The second is the problems and mechanism construction faced by the family doctor policy. Due to the ambiguity and conflict in the current family doctor policy, there has been a long-standing dilemma of “signing but not agreeing” in the implementation of family doctor policies. Scholars have explored the reasons why family doctor signing service policies are hindered from the perspectives of the structure and context of policy implementation (Gao and Rong, 2018), as well as issues such as human resource gaps, insufficient incentives for family doctors, and the lack of corresponding supporting facilities (Lu and Wu Zhong, 2015).In summary, existing research has not focused on the impact of collaborative governance among local government departments and community organizations on policy implementation. Thus, collaborative cooperation among various departments and organizations of local grassroots governments is necessary, especially in cities with lower levels of develop-

ment. This article intends to take J City, a third tier city, as an example to explore the problems in the combination of collaborative governance with the implementation of the family doctor model.

## Research methods

The method of case analysis is adopted, which is based on literature research and interviews. Firstly, conduct a preliminary analysis of the internal project plan and policies, as well as relevant government documents; secondly, the interview method used is a semi-structured interview, with the main interviewees being government staff who hold key positions in the family doctor signing service project, including frontline staff or department heads from departments such as the Municipal Health Commission. The questions involved the contradictions and conflicts that arise between the collaboration of various governance entities that the interviewees face when implementing policies. 5 interviewees from different departments were interviewed. In addition, interviews were conducted with some family doctors and residents who had signed with family doctors. Based on the above information collection channels, this paper has obtained 14 pieces of effective information, including relevant Report on the Work of the Government, community implementation plan and family doctor work report, involving 10 subjects.

## Results

According to a survey, there are a total of 21 family doctor signing institutions in J city, with 482 family doctors, responsible for approximately 2000 people per family doctor. The total population of H community is 13420, with 2840 signed family doctors. There are a total of 3 family doctors in the community. And according to relevant documents issued by the provincial government, in principle, each family doctor service team is responsible for 600 households, with a maximum of 800 households; the number of people is around 2000. Each family doctor serves no more than 200 households, with a population of approximately 600 people.

## Discussion

The contract management model for family doctors requires the establishment of effective mechanisms with departments such as medical insurance and pricing. The health and family planning administrative department needs to develop admission standards, service processes, and division of labor guidance for family doctor teams with grassroots medical and health institutions based on actual situations, In addition, collaborative governance needs to be carried out by government departments such as the Municipal Health Commission, some public hospitals, and community health service centers or health centers in pilot streets. Collaborative governance refers to the process of government, economic organizations, social organizations, and the public, within a predetermined scope, with the goal of maintaining and promoting public interests, and with existing laws and regulations as common norms, under the leadership of the government, through extensive participation, equal consultation, cooperation, and joint action, jointly managing social and public affairs, as well as the sum of various methods used in this process.<sup>[5]</sup>

## 1. Existing problems

### 1.1 There is a phenomenon of ‘signing without signing’

#### 1.1.1 Insufficient number of family doctors

According to relevant documents issued by the provincial government, in principle, each family doctor service team is responsible for 600 households, with a maximum of 800 households; The number of people is around 2000. Each family doctor serves no more than 200 households, with a population of approximately 600 people. The relevant departments are also facing problems when trying to increase the number of family doctors. J City does not offer higher salaries and benefits to family doctors compared to other cities with higher economic development levels, so they are unwilling to work here.

#### 1.1.2 Residents still hold a reserved attitude towards the “family doctor service model” for new students

According to the interview results, even though most residents have already signed a family doctor, they still choose to go to the hospital first when facing health problems. In order to complete the tasks of residents signing contracts and establishing health records, many com-

munities have begun to gather acquaintances to sign contracts to increase the signing rate. For residents who are more actively participating in signing contracts, the psychological gap of not enjoying the policy benefits after signing contracts has led to a lack of trust in the executors, and has also exacerbated the difficulty of carrying out family doctor signing work on a larger scale.

## **1.2 There are financial issues**

Each department of the grassroots government needs corresponding houses as office locations when participating in community collaborative governance. According to staff from relevant government departments, the community did not provide government related preferential policies, including water and electricity fees, when renting houses to the government. The Municipal Health Bureau divides financial allocation according to the proportion of signing contracts, leading to blind increase in the signing rate in the community. In this situation, each responsible party responsible for signing the contract will try to achieve or even exceed the signing rate target set by the superior institution.<sup>[3]</sup>

## **2. Countermeasures**

### **2.1 Strengthen vertical and horizontal linkage between departments**

Firstly, strengthen vertical communication and collaboration among medical institutions, and optimize two-way referral. Secondly, strengthen horizontal linkage between departments. The Health and Family Planning Bureau should strengthen its organizational leadership and coordination capabilities, establish a government led collaborative mechanism with relevant departments, clarify the responsibilities of various governance entities, and achieve collaborative governance. Therefore, medical institutions at all levels need to clarify their own positioning and responsibilities, build good collaborative relationships, improve referral standards and processes, and increase regulatory efforts to ensure the implementation of relevant systems and policies.<sup>[2]</sup>

### **2.2 Expanding the number of family doctors and enhancing professional attractiveness**

Reform and innovate the employment, promotion, continuing in-service education, and training systems for family doctors. The standardized training of general practitioners is currently a top priority in strengthening and enhancing the construction of grassroots medical teams. However, top-level design and strong promotion are also needed.

## **References**

- [1] Liang Tukun. A Study on the Accessibility of Family Physician Policy and Its Citizenizational Effect ——Based on the Empirical Analysis of the Monitoring Data of Migrant Population in Guangzhou, Taiyuan and Chongqing in 2018. *Lanzhou Academic Journal*. 2022; (12): 52-67.
- [2] LI Lele, LI Yixuan, CHEN Xiangyu, GAO Jianzhe, WEI Donghao. Research on the Impact of Community Family Doctor Contracting on the Utilization of Medical Services for the Elderly. *Social Security Studies*. 2022; (02): 45-58.
- [3] GAO Herong. Signed Without Agreement: Why Family Doctor Service Policy Hindered. *Journal of Northwest University (Philosophy and Social Sciences Edition)*. 2018; 48(03): 48-55.
- [4] LU Yu, WU Zhong. Assess the Effect of Implementation of Family Doctor System. *Scientific Decision Making*. 2015; (11): 18-34.
- [5] ANSELL C & GASH A. Collaborative Governance in Theory and Practice [J]. *Journal of Public Administration Research and Theory*, 2008; 18(4): 543-571.

# High school chemistry teaching design based on project-based learning

## —— Scientific understanding of iron supplement

Fenyng Zhao

Tianshui Normal University, Tianshui 741000, China.

---

**Abstract:** In order to deepen the reform of basic education teaching, change the teaching method and explore the penetration of project-based learning in basic education, in the teaching of “iron and its compounds” the evaluation gauge is set to provide the direction for students to improve the learning content and methods. The theme of “Scientific understanding of iron supplement” is to let students feel and understand in the real situation and the significance of knowledge, promote the deep understanding of the core knowledge of chemistry, establish the relationship network of the experience that chemistry comes from life and serve our life, gradually develop the core literacy and provide reference for comprehensively improving the quality of teaching.

**Keywords:** High school chemistry; Project-based learning; Iron and its compounds

---

At present, the field of education world-class transformation, which is due to the transition from the industrial age to the information age. As a result of the challenge of artificial intelligence, the demands of work on people are also increasing, namely, the ability to think critically and innovate. 《Opinions on Deepening the Reform of the Education System Mechanism》 also put forward that we should pay attention to cultivating students ability of independent thinking, teamwork and innovation, which put forward higher requirements of basic education. Students are required to not only acquire knowledge in school education, but also have the ability to use what they have earned to solve problems creatively, pay attention to basic and practical, and realize the promotion from low-order ability to higher order thinking. The literacy orientation is reflected in the classroom transformation. The chemistry classroom teaching requires students to comprehensively apply the subject knowledge and skills to the new uncertain situation, solve the real social life problems, and gradually move towards the subject creation of chemistry and enhance the understanding of chemistry. Project-based situations, teachers set challenging problems or tasks, organize students to autonomous cooperation, and display project results and works. To carry out project-based teaching in chemistry teaching in senior high school, the starting point is to change students' learning mode, and the goal is to cultivate higher-order thinking and develop students' core quality.

### 1. Project theme content analysis

The deep learning of chemistry is that under the guidance of teachers, students carry out experiment-oriented inquiry activities, and gradually develop the core quality of chemistry in the process of solving problems in real situations<sup>[1]</sup>. Project-based learning is based on real problems and situations, closely links learning with real life and practice, and focuses on cultivating students' ability to solve practical problems from the level of relevance structure, which is consistent with the concept of deep learning. The structuring and contextualization of curriculum content is mentioned in 《General Senior High School Curriculum Program(2017 Edition)》. Content structuring requires students to enrich cognitive structure and make connections diversified. Content contextualization requires students to solve problems in the real situation, so that the knowledge learned in school is no longer inert and can be transferred to the real problem situation which is the meaningful deep learning. This requires teachers not only to pay attention to the integration of knowledge within the subject, but also to design teaching in connection with real life, and pay attention to the forefront of the development of The Times. Teachers summarize the complicated curriculum content and sort out the ones with lasting transfer value within the discipline basic concepts, principles or methods, which can help students to accurately and deeply understand chemical knowledge, realize knowledge transfer, establish a more complete knowledge structure, and transform it into ideas and methods to solve real world problems.

As a new course, “Iron and its compounds” should focus on the mutual transformation and expansion of application between  $\text{Fe}^{2+}$  and  $\text{Fe}^{3+}$ . This lesson combines the requirements of 《General Senior High School Curriculum Standards of Chemistry<sup>[2]</sup>(2017 Edition, 2020 Revision)》 (“properties of Iron and its Compounds “for students to do experiments and carry out” “experiments on the properties of Iron and its compounds, preparation of ferrous hydroxide and other activities), teaching materials, students have the foundation, from the perspective of biology, to emphasize the physiological role of iron in maintaining human life activities; From the perspective of the chemistry, it emphasizes the composition, properties, transformation and uses of substances; From the perspective of materials science of good iron supplement packaging material sand technologies, etc and pay attention to the cross integration of multi-disciplines. Based on the internal connection between knowledge, the project theme that carries the core knowledge of chemistry and the thought and method of chemistry discipline is sought, and the project theme of “Scientific understanding of iron supplement” is established The project tasks are divided into several independent and progressive sub-projects: identifying iron in iron supplements, understanding the development history diagram of iron supplements<sup>[3]</sup>, carrying out a series of scientific inquiry activities promoting deep learning in real sense, and promoting problem solving ability. Through the method of studying substances with classification thought was odium metal and its compounds is established; the study of nonmetallic chlorine and its compounds embodies the method of studying the properties of substances from the point of view of valence, iron is a variable valence element, which can help students to construct a transformation model from two perspectives of substance category and element valence (as shown in Figure I), strengthen the mutual transformation between different valence states of iron, further enrich the understanding of classification view, transformation view, ion reaction, redox reaction, and learn sodium and chlorine, sulfur, nitrogen and their compounds, as well as the structure of matter and the aw of elements Refine the big concept of “Understanding the nature and transformation of inorganic substances based on the substance class and the valence state of the element”, so as to make the knowledge of inorganic compounds structured.

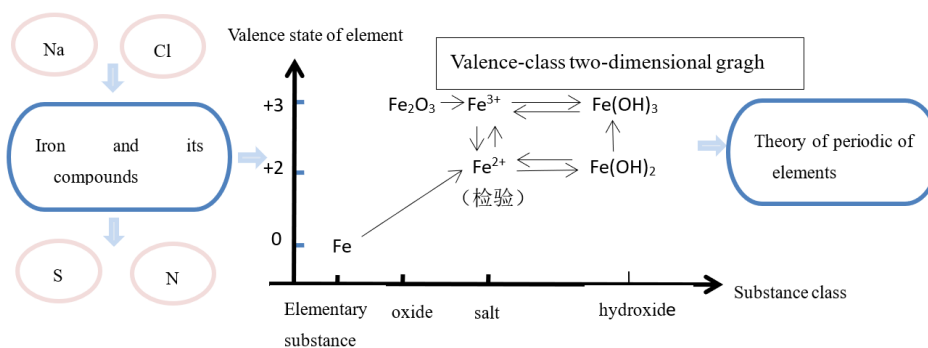

Figure I structural frame diagram of “Iron and its compounds”<sup>[4]</sup>

## 2. Teaching objection of the project

In the teaching of “Scientific Understanding of Iron Supplement project, according to the corresponding content requirements and academic requirements in the curriculum standards, combined with relevant teaching resources and students’ learning situation, the project teaching objectives are formulated:

- (1) To understand the human body through understanding the role of iron in the human body. The principle of absorbing iron, understanding the great contribution of chemistry to the research of pharmacology, and feeling the application value of chemistry in human health.
- (2) By exploring the reparation of  $\text{Fe}(\text{OH})_2$ , experience the value of literature and form a rigorous and realistic attitude. To explore the reductibility of vitamin C and strengthen the awareness of evidence reasoning.
- (3) By constructing a two-dimensional cognitive model, the transformation relationship between iron-containing substances is sorted out to form a knowledge structure. Through the use of materials around to test Fe, forming the consciousness of sustainable development of saving resources and protecting the environment.
- (4) Through the analysis of iron supplement packaging materials and technology, water solubility, absorption effect, comprehensive application of multidisciplinary knowledge to solve the problem in the real situation, develop interdisciplinary thinking.

### 3. Evaluation of project results

In order to evaluate learning fairly, improve practical and effective feedback, and provide directions for improvement in student learning content and methods, detailed evaluation gauges have been developed (as shown in table I).

Table I “Scientific Understanding of Iron Supplement” evaluation gauge<sup>[5]</sup>

Project topic	Scientific understanding of iron supplements
Task1: Analysis iron is in the human body's role	C1: Understand the symptoms and manifestations of patients with iron deficiency anemia; ( 2 points) C2: knows that iron is an important component of hemoglobin; ( 2 points) C3: links biology to analyze iron's involvement in blood oxygen transport and REDOX metabolic processes. ( 4 points)
Task 2: Identification Iron supplements	C1: Master the testing methods of $Fe^{2+}$ and $Fe^{3+}$ ; ( 3 points) C2: According to the experimental phenomenon, the inner core and outer composition of ferrous sulfate supplement were analyzed; ( 3 points) C3: Conjecture on the composition of the grey-green precipitate and group discussion on designing feasible preparation Solution of $Fe(OH)_2$ ; ( 3 Points) C4: Explore and explain the reason why strong tea can not be drunk when taking oral iron supplement, but take Vitamin C together can promote iron absorption reasons; ( 3 Points) C5: Construct the conversion model between iron-containing substances from two perspectives of valence-class, and explain the reasons; ( 3 Points) C6: Put forward the use of materials around to complete the Fe2t inspection scheme. And verify the feasibility, form the awareness of sustainable development of saving resources and protecting the environment. ( 5 points)
Task 3: Know iron supplement exhibition history	Level 1: Compare different iron supplements to understand the advantages and disadvantages; Using conservation thought, analysis can not over supplement iron, in more point structure level; (3 points) Level 2: Combine physiology, pharmacology and chemistry knowledge, analyze the pharmacological mechanism of ferrous sulfate and ferrous succinate, and reach the multi-point structure level; (5 points) Level 3: From the perspectives of physiology, pharmacology, chemistry, material science and technology, the selection of iron supplement packaging materials, water solubility and body absorption effect can be analyzed to achieve the level of correlation structure. (8 points)
Task4: Recognize iron in food	C1: give examples of iron-rich foods, (3 points) C2: help make dietary recommendations for people with iron deficiency anemia. (3 points)

### 4. Project teaching implementation process

#### 4.1 The role of iron in the human

**【Question】** According to a study in 2010, one-third of the world's population suffers from anemia, and iron deficiency anemia accounts for about half of them<sup>[6]</sup>. So what is the important role of iron in the human body?

**【Group report】** The source of iron in the human body, one is from food; Second, endogenous iron mainly comes from aging and damaged red blood cells. When the human body is iron deficient, the amount of hemoglobin synthesized by red blood cells is reduced, resulting in the small size of red blood cells and the decrease of oxygen carrying capacity, forming iron deficiency anemia. Iron is an important component of hemoglobin in red blood cells and participates in blood oxygen transport and redox metabolism in the body. So  $Fe^{2+}$  should be included in iron supplements.

Under the action of iron reductase  $Fe^{3+}$  is converted into  $Fe^{2+}$ , stored in the liver, bone marrow, called ferritin. When ferritin enters the serum, it forms serum ferritin. When used,  $Fe^{2+}$  is converted to  $Fe^{3+}$  by iron oxidase, and  $Fe^{3+}$  binds to transferrin in the plasma to form serum iron<sup>[7]</sup>.

**【Question】** Are there any iron deficiency anemia patients around the students? What do you know about iron deficiency anemia?

**【Group report】** Consult the data, found that iron deficiency in the body is a gradual process from light to heavy, initial iron deficiency, storage iron consumption adjustment, serum ferritin concentration decreased; metaphase iron deficiency, serum ferritin concentration decreased, serum iron also decreased, red blood cell free protoporphyrin concentration increased; Severe iron deficiency, in addition to the

above indicators change, hemoglobin and hematocrit ratio decreased, human iron deficiency performance including fatigue, fatigue, palpitation, breathing difficulties, headache, pale skin and so on. The main patients of iron deficiency anemia are preschoolers (<5 years old), women of childbearing age and pregnant women.

**【Data card】** Iron deficiency anemia is attributed to the imbalance between the body's demand and supply of iron, resulting in a decrease in the hemoglobin content in red blood cells and a decrease in the number of red blood cells. When there is severe iron deficiency anemia, the patient needs to take iron supplements to treat, let's explore the secret of iron supplements.

## 4.2 Explore the secret of iron supplements.

### 4.2.1 Identification of iron in iron supplements

**【Question】** Show the iron supplement (ferrous sulfate tablet) What method can we use to identify the  $Fe^{2+}$  in the iron supplement?

Table 2 Test of  $Fe^{2+}$  and  $Fe^{3+}$

	$Fe^{2+}$	$Fe^{3+}$
observational method	laurel-green	claybank
alkali addition	the white precipitate quickly turns gray-green and finally reddishbrown	Reddish brown precipitate
add KSCN	after adding KSCN solution, there is no obvious phenomenon, and then adding $H_2O_2$ solution, the solution turns blood red	after adding KSCN solution, the solution turned blood red
method of precipitation	add $K_3Fe(CN)_6$ solution, with blue precipitates generated	add $K_4Fe(CN)_6$ solution, with blue precipitates generated

**【Group report】** 1. Ferrous sulfate tablets are dissolved in distilled water and drops of KSCN solution showed no obvious phenomenon. 2. Ferrous sulfate tablets are dissolved with hydrochloric acid, and the solution is added with KSCN solution, and the solution turn blood red.

**【Analytical reasoning】** The inner core of ferrous sulfate tablets contains  $FeSO_4$ , and  $Fe^{2+}$  is easy to be oxidized, so  $Fe_2O_3$  is wrapped in its outer layer. Because  $Fe_2O_3$  is an alkaline oxide, soluble in hydrochloric acid, easily dissolved by stomach acid, in the body it is reduced to  $Fe^{2+}$ , thereby improving the absorption rate of iron supplements.

**【Student】** The experiment found that the use of alkali method to identify  $Fe^{2+}$ , the white precipitate will quickly become grayish green, why?

**【Discussion】** White  $Fe(OH)_2$  is easily oxidized, but  $Fe(OH)_3$  is a reddish-brown precipitate. and the gray-green precipitate may be a mixture of  $Fe(OH)_2$  and  $Fe(OH)_3$ .

**【Document literature】** Using hand-held technology, the researchers found that the initial light gray-green precipitate was not a mixture of  $Fe(OH)_2$  and  $Fe(OH)_3$ , but an  $Fe(OH)_2$  colloid adsorbed with  $Fe^{2+}$ [8].

**【Group report】** White  $Fe(OH)_2$  easy to be oxidized, need to prevent the interference of oxygen, prepare the solution with distilled water after boiling and cooling, in addition, vegetable oil can be liquid sealed; reduce the concentration of  $Fe^{2+}$ , while increasing the concentration of lye, can prevent  $Fe^{2+}$  from being adsorbed.

**【Question】** That contains both  $Fe^{2+}$  and  $Fe^{3+}$  in the acidic solution of ferrous sulfate tablets. How do you test it?

**【Group report】** Take two identical parts of the above solution and drop KSCN solution into one. The solution immediately turns blood red, to prove that it contains  $Fe^{3+}$ . And a solution of KSCN was added to the other, no obvious phenomenon was observed, but acid  $KMnO_4$  was added to the other, the solution turned blood red, proving the presence of  $Fe^{2+}$ .

**【Summary】** The idea of testing certain particles in real complex system

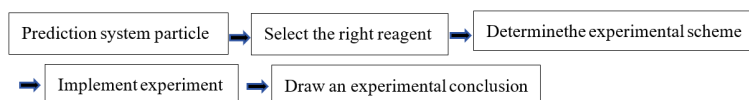

**【Pharmacological effect】** During oral iron, tea should be avoided as much as possible, especially strong tea, but with vitamin C, can promote iron absorption. Why?

**【Experimental investigation 1】** 1. Add tea to 25ml beaker about 1g, and then brew with boiling water, after a period of time to get strong tea. 2. Add 3 drops of  $\text{FeSO}_4$  solution to 2ml of strong tea water, observe the phenomenon, and then add 2 drops of vitamin C solution, oscillate and observe the phenomenon.

**【Phenomenon】** Add 3 drops of  $\text{FeSO}_4$  solution, observed that the tea turn blue black, and then add vitamin C solution, the tea return to the original color.

**【Data card】** Polyphenols in the tea react with  $\text{Fe}^{2+}$  to form tea polyphenol ferrous complex, the electrode potential between FeIII /FeII will be greatly reduced, the reductive property of FeII is enhanced, and it will soon be oxidized into blue-black precipitate of tea polyphenol iron, which can significantly inhibit the absorption of non-heme iron<sup>[9]</sup>.

**【Conclusion】** 1. Vitamin C is reductive. 2.  $\text{Fe}^{2+}$  in solution can be converted to  $\text{Fe}^{3+}$  by selecting suitable oxidant. And the appropriate reducing agent can convert  $\text{Fe}^{3+}$  to  $\text{Fe}^{2+}$  in the solution. Therefore, adding vitamin C to iron supplements can promote the absorption of iron, enhance the effect of iron supplementation and prevent the deterioration of iron supplements.

**【Summary】** Conversion between  $\text{Fe}^{2+}$  and  $\text{Fe}^{3+}$

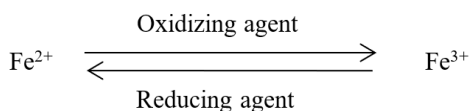

Figure 2 Conversion model between  $\text{Fe}^{2+}$  and  $\text{Fe}^{3+}$

**【Task】** Please establish the Fe,  $\text{Fe}^{2+}$ ,  $\text{Fe}^{3+}$  mutual conversion network diagram from the perspective of redox reaction.

**【Results Show】** Construct the conversion between iron-containing substances from the perspective of “valence - class”(Figure 3)

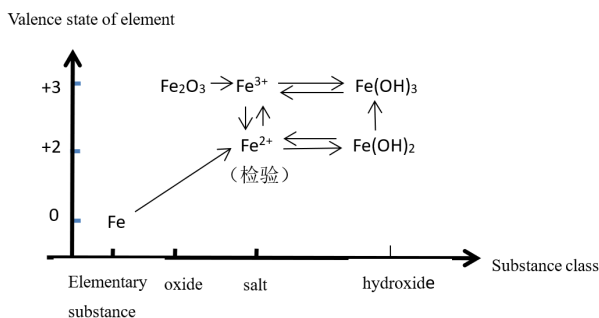

Figure 3 iron-containing substances from the perspective of “valence - class”

**【Student】** If we want to test  $\text{Fe}^{2+}$  at home, how do we choose reagents and instruments?

**【Question】** Students brainstorm, the experiment need:  $\text{Fe}^{2+}$  in the solution under test, alkaline solution, oxidizing agent, reducing agent, plant oil and the reaction container, etc. Think about how to use the materials around you to complete the experiment?

**【Student 1】**  $\text{Fe}^{2+}$  can be obtained by reacting iron nails with vinegar, or directly with iron supplements. The reaction container can be made of medical waste penicillin bottle or disposable syringe.

**【Student 2】** “84” disinfectant can be used as an oxidizing agent, and vitamin C can be used as a reducing agent.

**【Student 3】** The sodium hydroxide used to unclog drains can be used as an alkaline solution.

**【Group report】** White precipitate can be observed, and then inhaled “84” disinfectant, white precipitate immediately changed to red-dish-brown precipitate.

**【Student】** The experiment found that the reaction rate of iron nails and vinegar is relatively slow. What method can be used to increase the reaction rate?

**【Discussion】** The carbon rod in the discarded No.1 battery or the discarded copper wire can be used to form a galvanic battery to speed up the reaction.



#### 4.2.2 Understand the development history of iron supplement

**【Question】** If you are a drug researcher, what problems should be considered?

**【Student】** The selection of packaging materials for iron supplements should adopt good packaging technology and coating materials, not only to protect the iron and other nutrients in the supplements from loss, but also to facilitate swallowing; 2. Various groups of people should be considered when writing the instructions of the supplement, indicating the ingredients, indications and adverse reactions. 3. Water solubility and body absorption effect of iron supplement.

**【Data card】** Types of iron supplements

Types of iron supplement	Representative	Characteristic
First generation iron supplement (inorganic iron)	FeSO <sub>4</sub>	cheap; low absorptivity; rusty taste; side effects on the gastrointestinal tract were significant
Second generation iron supplement (conventional organic iron)	Ferrous succinate; Ferrous fumarate; Ferrous gluconate	little irritation to the gastrointestinal tract; Long-term is easy to produce black tooth staining; rusty taste
Third generation iron supplement (new organic iron)	Ferric sodium edelate; Ferric hydroxide polymaltose compound	no rusty taste; high absorptivity; little irritation to the gastrointestinal tract;

**【Question】** How should we choose and take iron supplements?

**【Student】** When choosing the drug for iron deficiency anemia, the drug with high absorption rate should be preferred. It is important to pay attention to the large dose of supplementation. Filling iron is easy to lead to acute iron poisoning, when there is iron deficiency anemia, taking iron supplements can increase the amount of hemoglobin, and then gradually increase the amount of stored iron, so we must adhere to the principle of as small amount, long-term, do not blindly use drugs, to follow the doctor's advice.

**【Knowledge development】** Ferrous succinate tablets are best taken after meals or meals to reduce its effect on stomach irritation, but also effectively improve its bioavailability, blood and serum iron levels should be checked regularly during treatment. After Fe<sup>2+</sup> in ferrous sulfate is oxidized to Fe<sup>3+</sup> by ceruloplasmin in the blood, it binds to plasma transferrin, and then enters the cell to bind protoporphyrin and globin to form Hb and promote Fe<sup>2+</sup> absorption<sup>[10]</sup>.

### 4.3 Understanding iron in food

Diet treatment is the basis of all kinds of anemia treatment, if the long-term partial diet, picky eating, may limit the intake of iron-rich food, resulting in long-term dietary iron can not meet the needs of the body. In plant foods, the main form of iron is non-heme iron (also known as plant iron), and the main form of iron in animal foods is heme iron. There are a lot of iron-rich foods in life, although the iron content of plant foods is higher<sup>[11]</sup>, but the human body has a better absorption of iron in animal iron-containing foods. Such as animal viscera, meat, fish, eggs and other animal food iron is easy to be absorbed.

**【Role Play】** As a drug researcher: Please help people with iron deficiency anemia make diet recommendations.

**【Group report】** Consult the data and make the following dietary recommendations:

- (1) Combine foods rich in vitamin C, such as citrus fruits. Strawberries, tomatoes, etc, can improve the absorption rate of non-heme iron.
- (2) After eating foods rich in phytic acid, avoid taking iron supplements or other iron-fortified foods immediately, as phytic acid can affect iron absorption.
- (3) Try to avoid foods rich in phytic acid after consuming foods high in calcium, as phytic acid combines with calcium to affect iron absorption.

## 5. Epilogue

This lesson takes "Scientific Understanding of iron supplements" as the project teaching theme. Teachers guide students to identify iron supplements, take iron supplements and a comprehensive understanding of iron supplements which is to experience the value of chemistry. In students' thinking to find available addition, if you are a pharmaceutical researcher be taken into account when studying iron supplements,

apply multidisciplinary knowledge to solve problems in real life. After class, the author interviewed situations, and feel that chemistry comes the students about the learning task of and the students all agreed that classroom learning in project tasks can better inspire initiative and curiosity for full exploration. And can be well connect complicated and redundant knowledge in series. It builds a bridge between real world and school education. Ren Xuebao said: "Teaching and research is the secret weapon of China's basic education, and an important support for ensuring the quality of basic education." The teaching-oriented classroom understand the functional value of the teaching needs to use the power of the curriculum content, consideration of problem, activity, selements and knowledge matching. To ensure that each driving question and core activity points to the development of students' ability cultivation<sup>[12]</sup>.

Today, with the rapid development of information technology, project-based learning will be combined with big data, artificial intelligence and other technologies to accurately analyze students' earning and provide support for personalized teaching. However, the promotion of the concept of project-based curriculum needs the cooperation and support of education departments, schools, teachers and parents, so as to promote the education reform to pay more attention to the development of students' ability and literacy.

## References

- [1] Jiuhua Hu. Chemistry teaching with deep learning to promote core literacy development [J]. Basic Education Curriculum, 2019, (21): 70-78.
- [2] Ministry of education of the People's Republic of China, General Senior High School Curriculum Standards of Chemistry (2017 Edition, 2020 Revision), Beijing: People's Education Press, 2020: 15-17.
- [3] Jiaqi Liu ,Lin Shengxuan ,Zhang Lang. Project-style teaching design of "Iron and its Compounds" -- taking "mumaing iron fertilizer as an example[J]. Experiment and Equipment for Primary School, 2023, 33(03): 14-17.
- [4] Chuqi Xie. Research on teaching design of high school chemistry large unit based on deep learning [D]. Guangzhou University, 2023.
- [5] Xianjin Hu, Fenghua Xu. Project-based teaching practice and element analysis for students' subject understanding: Take "homemade chlorine-containing disinfectant" as an example[J]. Education in Chemistry, 2023(09): 41-45+67.
- [6] J N K ,Rashmi J ,Mohsen N , et al. A systematic analysis of global anemia burden from 1990 to 2010[J]. Blood, 2014, 123 (5): 615-24.
- [7] Zheng Hu, Xu Hengyu. Discussion on trace element iron and human health[J]. Agriculture of Henan , 2009, (07):58-59.
- [8] Chengdong Zhu, Sun Yongcheng. Further improvement of ferrous hydroxide preparation [J]. Teaching Examination, 2023, (41):59-62.
- [9] Shun Dong, Bo Cheng. Experimental study on the interaction of tea water with ferrite [J]. Education in Chemistry, 2021, (07): 60-64.
- [10] Yanjie Liu. Effects of combined treatment of ferrous sulfate and ferrous succinate tablets on blood related indexes and pregnancy outcomes in patients with iron deficiency anemia during pregnancy Tuan [J]. Chinese and Foreign Medical Research, 2023, 21(29): 60-63.
- [11] Yu Mao, Chen Bo ,Gu Ning. Research status and development trend of oral iron supplement[J]. Journal of Chinese Pharmaceutical Sciences ,2017, 36(11):621-626.
- [12] Jiuhua Hu, Tong Chu, Wang Xuan ,Yuan Liqin. Research on the ability composition, level rank and development progression of Chemistry teaching design for normal university students [J]. Chinese Journal of Chemical Education, 2022, 43(24): 70-78.

Fund project: This paper is the teaching design and practice of high school chemistry large unit based on deep learning of the graduate innovation Guidance Project of Tianshui Normal University in 2023 and the phased research results of project number TYCX2346, taking "iron and its compounds" as an example. The project is funded by the research management of Tianshui Normal University Practical Research.

About the author: Fenying Zhao (1985—, female, ethnic Han, Minqin County, Gansu Province; Master Degree Candidate; research direction: Discipline Teaching (chemistry).

# A study on the phenomenon of male couples' intimacy performance in short videos

Shuwen Chen

Jinan University, Guangzhou 510632, China.

---

**Abstract:** Nowadays, short videos have become a platform for many people to show their bodies and express their emotions, so that male couples can also take advantage of the short video platform to be more bold in publicizing their sexual orientation, and even to put their intimate relationships on display. And the gay community's activism in public space facilitates their access to more media discourse and promotes the realization of their identity. However, such face value-based performances of intimacy may be nothing more than fantasies of romantic love woven by people.

**Keywords:** Male couples; Short videos; Homosexual intimacy; Male consumption

---

With the increasing development of short videos, the gay community in short videos has also become more and more visible. They post photos, shoot short videos, open live broadcasts to communicate with other users, and even making their intimate relationships public and sharing their lives with others. In heterosexual orthodox society, the behavior of gay and lesbian groups as a minority group to show their intimate relationships in a public space has gained a lot of respect and blessings, and some couples have even accumulated a large number of fans, but there is no doubt that gay couples moving from private to public also need to bear a certain amount of risk and controversy.

## 1. Catalysts for coming out: the gaze on the male body

Baudrillard said, "In the full kit of consumption, there is one object that is more beautiful, more precious, more glorious than all the rest, and that is the body."<sup>[1]</sup> The abundance of material conditions makes people no longer satisfied with the consumption of things, the consumption of symbols has become the pursuit of people's fervor, in this process, the body has gradually been included in the symbolic system, and has become the object of people's consumption and aesthetics. The development of network technology has created a visual feast for people, in which the body is transformed into a symbol of visual culture, which is regulated into various forms under the construction of mass media, and then acts on the real body.

With the awakening of women's consciousness, the public's attention has gradually shifted from "looking at women" to "looking at men", and the male body has become an object of consumption, with various male figures such as warm men, strong men, fresh men, and beautiful men appearing on the screen. The public can obtain a sense of possession by consuming others, while screen men hope to obtain a sense of happiness by consuming themselves, which has further led to the emergence of short videos with low production thresholds that show their excellent body and appearance, and gradually accumulate fans and grow into netroots on short video platforms, such as "Wang BuRan" on the TikTok, which has 1.02 million fans.

The general state of existence of homosexuals in China at this stage is that they identify themselves as homosexuals but do not come out of the closet, probably because they have acquired the homophobia of the heterosexual society and formed a kind of internal self-sanctioning mechanism<sup>[2]</sup>, for which "coming out" is a kind of social death.<sup>[3]</sup> However, with the continuous development of Internet technology and the arrival of the era of male consumption, the gay community is more and more willing to put themselves in front of the public, acting out their intimate relationships and sharing the sweet details of their love affairs on the Internet, just like ordinary heterosexual couples.

The popularity and consumption of the male body on short video platforms has led to less public pressure on homosexuals to come out publicly, and the development of slash culture has made many people, especially women, more tolerant of intimate relationships between same-sexual. In the eyes of women who are passionate about slash culture, same-sex relationships are less burdened by responsibility, and the conclusion of such a relationship is not based on reproduction as the destination, but is more concerned about the feelings of the heart, which in itself represents a kind of cynicism and deviation from the norm.<sup>[4]</sup> This more "pure" emotion makes many people addicted, and real

gay couples have a more realistic context, not only in people's imagination, which makes more people willing to pay attention to and support them.

## **2. From exclusive to public space: the self-presentation of gay couples in videos**

Homosexuality and its concepts are different in different media eras. In the paper media era, homosexuality was stigmatized as both sin and disease. In the radio and television era, more images of homosexuals on the screen gradually dispelled the concerns of sin and disease; since entering the network era, network technology has created an "exclusive space" for homosexual groups, and to defend themselves from the offensive from outside world. The Internet technology has changed the way people socialize, with offline interactions gradually moving online, the socialization of strangers on the Internet is not as easy for gay men to coalesce.

However, while the development of cyber technology may seem to weaken "the sense of community cohesion that has been built up in gay-exclusive spaces and places, such as gay bars"<sup>[5]</sup>, the new cyberspace has also given gay the possibility to build new social interactions and community connections between the real and the virtual.<sup>[6]</sup> In the public cyberspace, some "heterogeneous spaces" have been established, like "Sunny Zone" and "Blue", which is a new form of socialization for the gay community to create an exclusive space for themselves in the open cyberspace. Communication technology has changed the establishment and maintenance of intimate relationships. People can talk to any stranger in cyberspace through social media, and lead to a new relationship. For example, the gay couple "Jielin CP" on the TikTok began their acquaintance with each other's self-presentation on social media.

Social media has an impact on the day-to-day presentation of intimate relationships. For example, the openness dimension of romantic relationships between the sexes is greatly enhanced by social media.<sup>[7]</sup> Some gay and lesbian couples, like most ordinary heterosexual couples, share their sweet romantic details in video, such as "JieLin" "HaoHao NieNie" and "HeKai". Among them, the topic "#JielinCP" has 210 million fans, "#HeKai" has 270 million fans, and "#HaoHaoQuiQiuQiu" has 240 million plays in TikTok. Their popularity is evident. As a marginalized group in society, coming out from the "darkness" to stand in the sunlight is a kind of courage to throw oneself into the fray, and making the more private love routine public is more of a heroic romance, which may also be the reason why it impresses so many fans.

## **3. Access to media discourse is proving the identity and cultural identity of homosexual**

There is always a tension between sympathy, tolerance and recognition of homosexuality and the perception of it as pathological and perverse.<sup>[8]</sup> More and more homosexuals have accumulated a large number of followers through their practices on short video platforms, which also means that they have kinds of media discourse power, and they are able to counter stigmatization, and at the same time push gay and lesbian issues into the realm of public discourse, and promote gay and lesbian groups' own identities as well as society's recognition of gay and lesbian subcultures.

The performance of homosexual in short video platforms puts them at the center of public opinion. On the one hand, due to stigmatization and marginalization in the cyberspace dominated by heterosexual groups, and this kind of public "coming out" implies confrontation and conflict with the mainstream discourse, and it is inevitable that they will be obscured, rejected and even abused, they may be more silenced. On the other hand, there are also someone support the gay community, and related topics will lead to common discussions between homosexuals and others communities. In the course of continuous discussion, negotiation and reflection, the gay community may gain more understanding and become more resolute about their identity, alleviating the binary opposition between homosexuality and heterosexuality and expanding the inclusiveness of mainstream social space.

At the same time, more homosexual couples have shown homosexuals their true situation, which also helps those homosexuals who are still hiding in the dark to identify themselves, break free from confusion and guilt, and alleviate the long-standing marginalization and stigmatization of the individual, and inspires more homosexuals to dare to express their sexual orientation in open online platforms, and to challenge and even structure the hegemony of heteronormative discourse.

## **4. Reflection: a romance against the world or a fantasy of love utopia**

Gay have provided Chinese women with a discursive space in which they can freely talk about and gaze at the male body and sexuality in an uninvolved manner.<sup>[9]</sup> The paradigm of heterosexual love between a man and a woman is fundamentally incapable of carrying women's

beautiful expectations of utopian love, and so the slash text opens the floodgates for such fantasized sleepwalking.<sup>[10]</sup> But, the gay who exist in slash texts are virtual characters that can be compiled, and their love stories are also works that have been created, in which the author's writing can almost perfectly match people's imaginations of romantic love, and can defy the world to fight against the ostracization of the heterosexual orthodox society. If placing this romantic fantasy in a realistic context, are the romantic routines of gay couples fighting the world in short videos actually fantasies wrapped in a beautiful package?

If we look at the gay men in short videos, it is not difficult to find out, that the gay couples who dare to come out in public, and are willing to show their private relationships in public, are all men who have excellent physical appearance. "Beauty is governed by the culture of a society. It is a symbol, a vehicle, and a metaphor for the culture of a society".<sup>[11]</sup> So to what extent is the respect and support for the gay male community presented in short videos today based on face value, and is the more average-looking gay community receiving more ill-will as they emulate them in exhibiting their own lives? These are questions for further study.

## References

- [1] Jean Baudrillard (F). The Rise of Western Consumer Society and Cultural Mirror [M]. Beijing:China Social Science Press,1970:140.
- [2] Qingfeng Wang. Identifying but not "coming out"—an investigation of the survival status of homosexuals [J]. Journal of China Agricultural University (Social Science Edition), 2011(4):142.
- [3] Yoshino Kenji. Covering up: the double life of homosexuality and beyond [M]. Jingshu Zhu , Translation . Beijing: tsinghua university press, 2016: 65
- [4] Qinghe Zhu, Xiaoming Zhang. Media Empowerment and Value Dispelling of Delay Culture[J]. Modern Communication(Journal of Communication University of China),2017,39(04):12-17.
- [5] Luo Wang. Conceptual change and characterization of homosexuality in media evolution[J]. Today's Media,2015,23(02):175-176.
- [6] Liang Wang."The desire of other bodies": desire, body and sexual practice in cybersex [J]. China Youth Research, 2019( 4) : 27-33.
- [7] Jun Jing,Xiaoshu Sun,Peifeng Zhou.Intimate strangers:Gay men's dating patterns in three Chinese cities[J]. Open Times,2012(08):107-117.
- [8] Lenhart & Madden, 2007 Buber, Martin, 2002, Me and You, translated by Weigang Chen,Beijing: Sanlian Bookstore.
- [9] Weidong Lian. Gay and lesbian community and its construction in cyberspace [J] . Southeast Communication,2007( 5): 39-40.
- [10]Jingyi Zhang. Corrupt Girls:The Era of "Male Colors" Consumption and Girls' Utopia[J]. Masterpiece Appreciation,2015(19):87-91.
- [11]Jian Guan. Exploration of the phenomenon of face value worship under the perspective of social psychology[J]. People's forum,2020(24):87-89.

# A Study on the Chinese-English Translation of Domestic Movie Titles from the Perspective of Skopos Theory

Haiyan Zhou

Xi'an International Studies University, Xi'an 710000, China.

---

**Abstract:** In the context of film globalization, movie titles, as important cultural symbols, have a significant impact on the promotion of movies. However, there are currently limited researches exploring the Chinese English translation of domestic movie titles from the perspective of Skopos theory. Therefore, this study analyzes the Chinese-English translation strategies and effects of domestic movie titles, as well as the purpose, objectives, and translation methods in the translation process, through the three rules of Skopos theory. The aim of this study is to provide a theoretical basis and practical reference for the translation of domestic movie titles from Chinese to English, improve the international spreading effect of movies, promote the development of Chinese-English translation research, and have important significance for promoting the development of domestic movies in the international perspective.

**Keywords:** Skopos Theory; Movie Titles; Chinese English Translation Strategies

---

## 1. Introduction

As an important cross-cultural communication medium, the title of a movie is not only the identification and naming of the movie, but also an important means of promotion and publicity. The translation of movie titles plays a crucial role in promoting communication and understanding between different cultures and is increasingly valued. However, translating movie titles involves multiple levels such as language, culture, and art, and translators often face various challenges and difficulties in the process of translating domestic movie titles from Chinese to English. At present, research on the Chinese English translation of domestic movie titles is still relatively limited, especially lacking research based on the perspective of Skopos theory. Therefore, it is necessary to carry out this research. This study will take Skopos theory as the theoretical framework, analyze a series of movie titles, explore the strategies chosen by translators in different contexts, and how these strategies affect the understanding and acceptance of target language audiences, thereby revealing the problems in movie titles translation. Through research and analysis, this study suggests that translators can use methods such as literal translation, free translation, transliteration, and modified translation to translate movie titles, in order to provide theoretical guidance and practical reference for the Chinese-English translation of domestic movie titles, provide more systematic and feasible guiding principles, and so as to promote cross-cultural communication.

## 2. Overview of Skopos Theory

In recent years, the widespread application of Skopos theory in the field of translation research has attracted great attention from scholars. Skopos theory is a translation theory proposed by German translator Hans Vermeer in the 1970s. The core viewpoint of this theory is that the purpose of translation determines the choice of translator, and it is believed that the purpose of translation directly affects the decision-making and selection of translation methods and strategies in the translation process<sup>[1]</sup>. According to the Skopos theory of translation, the purpose of translation is to meet specific communication goals and complete specific communicative tasks<sup>[2]</sup>. Therefore, the quality of translation should be evaluated based on whether the predetermined communication objectives have been achieved. In the translation of movie titles, this viewpoint has been applied, making researchers pay more attention to the impact of translation purposes on translation strategies and methods.

Skopos theory includes three major rules: Skopos rule, Coherence rule, and Fidelity rule<sup>[3]</sup>. (1) Skopos principle: The main focus of translation is to serve as a specific function or purpose in the target culture, which means that the translator needs to consider the target audience, the expected function of the translation, and the expectations of the client. (2) The principle of coherence: Translation should maintain internal coherence and consistency within its own context, rather than attempting to completely replicate the form, structure, and content of

the source text. This means that translators are free to adapt and modify the text as long as it achieves the expected purpose and maintains the coherence of the target language and culture. (3) The principle of fidelity: The translator should be faithful to the intention and spirit of the original text, but not necessarily copying word for word. The purpose is to achieve equal results in the target culture while considering language and cultural customs.

Overall, Skopos theory emphasizes the importance of considering the functional and communicative aspects of translation, rather than strictly adhering to literal or literal translation methods.

### **3. Overview of the role, influencing factors, and translation methods of movie title translation**

#### **3.1 The role of translating movie titles**

The essence of translation is to spread ideas on condition that translations of movie titles are correct<sup>[4]</sup>. In this sense, the movie title translation is the destination of all kinds of translation. Movie title translation is the process of translating the original title of a movie from the source language to the target language<sup>[5]</sup>. As an identifier of a movie, the movie title plays an important role in promoting the film, attracting box office from audiences promoting the market, summarizing the content of the movie, and shaping the brand image. The movie title mainly has three functions: informational function, aesthetic function, and commercial function<sup>[6]</sup>. The informational function serves as the most basic function of a movie title, which can convey partial information about the movie content to the audiences, allowing the audiences to have a preliminary understanding of the theme, content, and style of the movie, and thus determine whether they are interested in the movie. Aesthetic function refers to the fact that attractive movie titles can greatly influence the audiences' first impression of the movie, stimulate their curiosity and interest, and thereby increase the movie's popularity and viewing rate. In addition, due to the nature of films, their titles also have commercial functions, which can yield economic effects.

#### **3.2 The influencing factors of movie title translation**

There are many factors that affect the translation of movie titles, including cultural factors, historical allusions, aesthetic factors, and commercial factors. Cultural factor is an important influencing factor, and different languages and cultural differences determine the way titles are expressed in different target languages. Therefore, when translating movie titles, it is necessary to consider the acceptance and taste preferences of the target language audiences towards the film culture. Historical allusion is another influencing factor, and some movie titles may involve historical allusions or specific cultural backgrounds. When translating, translators need to possess relevant cultural knowledge and convey it through reasonable translation strategies. Aesthetic factors are also of great importance, and the translation of movie titles needs to conform to the aesthetic habits of the target language audiences, including appropriate symbolism. Therefore, accurately conveying the artistic quality of the movie to the audiences through translation is also crucial. In addition, commercial factors can also affect the translation of movie titles, including market demand and commercial interests. Sometimes, titles may need to be modified appropriately to attract audiences and highlight marketing strategies.

#### **3.3 Translation methods for movie titles**

Understanding the origin of the title in the context of the original film is a prerequisite for the correct translation of the title. Specifically, most of the titles of films are based on plots, backgrounds, themes, protagonists, and clues<sup>[7]</sup>. Therefore, according to different situations, four methods of translation as follows could help with film titles translation such as literal translation, free translation, transliteration, and modified translation. Each method has its own advantages and limitations. When choosing the translation method, it is necessary to consider factors such as meeting the audiences' needs, accurately conveying the core information of the movie, and conforming to cultural habits.

##### *3.3.1 Literal translation*

Literal translation, also known as direct translation, aims to translate every word in the source text word by word into the target language<sup>[7]</sup>. This method tends to maintain the original meaning of the title, but may overlook cultural and linguistic considerations. Due to the cultural differences of various countries, the title of an English film often has its own unique internal meaning, which is difficult to express

from the literal translation of the title. If the method of literal translation is used, it will not only be confusing, but also may lose the characteristics of the original title<sup>[7]</sup>. For example, the English literal translation of the Chinese movie “活着” is “To Live”. Although the translation accurately reflects the central theme of the movie, it fails to capture the emotional and historical connotations related to the original intention.

### 3.3.2 Free translation

Free translation, also known as dynamic equivalence, focuses on conveying the essence or overall meaning of the title rather than strictly following the original text<sup>[7]</sup>. This method can make the translation process more creative and flexible. For example, the Chinese movie 重庆森林”(Chongqing Senlin) was casually translated into English “Chungking Express”. This translation successfully captures the urban atmosphere and romantic narrative of the movie, providing international audiences with a title that can evoke more memories and appeal. Another example is the English title “Crouching Tiger, Hidden Dragon” of the Chinese movie “卧虎藏龙”, which uses free translation to show the hidden and soaring martial arts masters in the movie, while also having a certain poetic meaning in the English language. The selection of these title translation methods can accurately convey the core information of the movie and meet the cultural and aesthetic needs of the target language audience.

### 3.3.3 Transliteration

Transliteration involves using speech equivalents in the target language to represent the sound of the source language<sup>[7]</sup>. This method is usually used when the source text involves proprietary names (such as person names or place names). A prominent example is the Chinese kung fu film “英雄”(Ying Xiong), which is transliterated as “Hero” in English. This title maintains its original pronunciation and creates a sense of curiosity and admiration associated with heroic characters.

### 3.3.4 Modified Translation

Modified translation, as the name suggests, involves making slight modifications to the source text to enhance its communicative functions in the target language<sup>[7]</sup>. This method considers both cultural and linguistic factors, striking a balance between staying faithful to the original intent and appealing to the target audience. One illustrative example is the Chinese film “无间道”(Wu Jian Dao), which was modified translated into “Infernal Affairs” in English. This title not only captures the underworld ambiance of the movie but also invokes the idea of moral ambiguity and conflicts within.

Based on the Skopos theory, it can be concluded that the use of literal translation, free translation, transliteration, and modified translation by translators can make the translation more in line with the information, aesthetic, and commercial functions of the film, making it easier for the target language audiences to accept and more conducive to the promotion of the films.

## 4. Analysis of Translation issues of Movies Titles from the Perspective of Skopos Theory

As a globally artistic form, the translation of movies involves cross linguistic and cultural dissemination, and accurate translation of movie titles from Chinese to English is crucial. In the process of translating movie titles from Chinese to English, there are some issues related to language and cultural differences, cultural characteristics and audience acceptance, as well as plot and emotional expression.

### 4.1 Language and cultural differences

Translation is not only a transfer between languages, but also an exchange between cultures<sup>[8]</sup>. The whole process of translation is a process of cultural exchange. The translator “deals with individual words, and he deals with two kinds of different cultures<sup>[8]</sup>. The first issue faced in translating movie titles is the difference between Chinese and English languages and cultures. Firstly, there are differences in grammar structure and expression between Chinese and English, which may require some grammar adjustments or reorganization of sentence structure during the process of translation. Secondly, there are differences in the use of vocabulary and idioms between Chinese and English, which may involve some translation difficulties, such as how to accurately convey the meanings of Chinese idioms or English idioms. In addition, the differences between Chinese and Western cultures may also bring some challenges, such as the unique cultural symbols and symbolic meanings in Chinese that may not be properly conveyed in English. Therefore, when translating movie titles, it is necessary to consider the characteristics of the target language and culture to ensure that the target audiences can understand and accept the meaning of the



film title. Although the English title serves as a summary and expression, it cannot fully convey the cultural connotations of the original film. Therefore, in translation, it is necessary to adjust and transform the expression methods appropriately while retaining the original meaning of the title, in order to meet the needs of the target language and culture.

## 4.2 Cultural characteristics and audiences' acceptance

The close relationship between language and culture is destined for the close relationship between translation and culture<sup>[10]</sup>. The translation of movie titles also needs to consider cultural characteristics and audiences' acceptance. Different cultures have different preferences and habits for the naming and expression of movies, and translation requires selecting appropriate translation strategies based on the cultural background and taste of the target audiences. Some movie titles may reflect strong cultural characteristics and emotions, and if translated directly into English, they may lose their original charm and emotional color, making it difficult for audiences to truly appreciate the characteristics and emotions of the movie. In this case, translators can consider using English words or phrases with similar cultural characteristics and emotional colors to better convey the meaning and emotions of the original title. The English title of the movie "Chongqing Forest" is "Chungking Express". Although the literal translation of "Chongqing Forest" in English may be more accurate, considering the audiences' acceptance, the translation of "Chungking", which is more familiar to English speaking countries, can better convey the meaning and emotions expressed in the movie title.

## 4.3 Plot and emotional expression

As an artistic form with strong plot and emotional expression, movies should summarize the theme and core content of the movie through concise and powerful language, accurately conveying the plot and emotions expressed by the original title. This requires translators to fully understand the original title and movie plot, and choose appropriate words and expressions to ensure that the translation results can accurately convey the plot of the movie. In addition, emotional expression in movies also needs to be accurately conveyed in translation, including character emotions, tone of dialogue, and emotional color. At the same time, translators also need to be careful not to overly personify or exaggerate, in order to avoid misleading the audience's expectations of the movie.

By analyzing the translation of movie titles from the perspective of Skopos theory, it can be found that language and cultural differences, cultural characteristics and audiences' acceptance, as well as plot and emotional expression, have significant impacts on the translation. When translating movie titles from Chinese to English, translators need to consider these factors comprehensively and adopt appropriate translation strategies to ensure that the movie titles translation can accurately convey the meaning and emotions of the original meaning, while adapting to the needs of the target language and culture.

## 5. Conclusion

The study of translating movie titles from Chinese to English from the perspective of Skopos theory has attracted widespread attention and discussion, emphasizing the importance of understanding audience needs and preserving cultural characteristics in movie title translation. This paper makes a comprehensive analysis of translation principles and strategies in translating movie titles. Research has found that Skopos theory has been widely applied in translating movie titles from Chinese to English<sup>[6]</sup>. Translators should choose appropriate translation strategies and methods based on the needs of the target audiences and the cultural backgrounds of various movies. Meanwhile, the acceptance and feedback of the target audiences towards translation have significant impacts on translation quality and effectiveness.

Although scholars have previously provided some insights for the improvement of film translation quality and the success of cultural transmission by studying and analyzing the translation of specific movie titles, there are still some limitations in current research, such as limited sample size and limitations in research methods. Therefore, future research can further expand the sample size, use multiple methods for verification, explore more empirical studies to verify the applicability of Skopos theory in movie title translation, and thus gain a more comprehensive understanding of the practical and theoretical issues of translating movie titles from Chinese to English. Additionally, with the advancement of technology, it is also possible to study the application of automated translation tools in the framework of Skopos theory to improve the efficiency and quality of movie title translation.

## References

- [1] Reiss K, Vermeer HJ. Towards a general theory of translational action: Skopos theory explained. Routledge; 2014.
- [2] Vermeer Hans. Skopos and Commission in Translational Action. Venuti,L(Ed and Trans).Translation. London and New York: Routledge, 2000.
- [3] Vermeer,H,J. A Skopos Theory of Translation: Some Arguments for and against[M].1996.
- [4] Yang DL, Yang HY. On English translation of terms with Chinese characteristics. Shanghai Journal of Translators. 2006;(3):73-74.
- [5] Nida E .Language, culture, and translating[J]. Shanghai Foreign Language Education Press, 1993.
- [6] Nord, C. Translating As a Purposeful Activity Functionalist Approaches Explained. Shanghai: Shanghai Foreign Language Education Press, 2001.
- [7] He Y. Translation theories and methods of film titles[J]. Foreign Language Teaching, 2001, (01):56-60.
- [8] Yan XH, Liu XQ.Cultural gaps in Chinese-English translation and their strategies of translation [J].Chinese Science and Technology Translation, 2002, 2, (15) 8-10, 63.

# Analysis of the Application of Bamboo Weaving Technology in Furniture Design

Siyu Duan

School of art, Yunnan Minzu University, Kunming 650500, China.

---

**Abstract:** Bamboo weaving is one of the traditional handicrafts in China. It has a history of thousands of years, represents the civilization of a country and a nation, and is the crystallization of the hard work and wisdom of the working people. With the continuous development and change of The Times, the bamboo weaving technology and products are also constantly developing and changing. This paper will study the bamboo weaving craft and the bamboo weaving furniture.

**Keywords:** Bamboo weaving technology; Furniture design

---

## 1. Overview of bamboo weaving process

“In China, bamboo weaving is a molding technique with bamboo. It is a traditional weaving technique and also one of the traditional modeling techniques with various categories.”<sup>[1]</sup> And has the precipitation of historical and cultural connotations, and exquisite technical techniques. In the long history, bamboo weaving products are the basic living utensils that people need from beginning to end. Traditional bamboo weaving technology is produced by the continuous needs and practices of the working people in life. It generally has various kinds of living utensils and works of art, with artistic culture and practical functions, reflecting the combination of bamboo culture and human wisdom.

The earliest bamboo weaving is human to avoid the attack of wild animals, using the characteristics of bamboo thin skin, but good toughness, bamboo weaving “wall”, their rest place with bamboo woven around. Early bamboo products had bamboo baskets, mainly used to store food; bamboo ware for fishing, bamboo mats for sitting, lying, etc. The middle stage of bamboo weaving pattern patterns gradually emerged. In the later stage, bamboo weaving technology was further developed and has been widely used in people’s production and life. Due to the large demand for bamboo weaving products, their types and colors have also increased, including square, round, corner, waist shape, and other modeling forms. The woven bamboo thread is closely arranged and can weave many patterns.

With the development and change of society and economy, bamboo weaving skills also continue to inherit and develop, but the whole shows a declining trend, only some bamboo weaving daily necessities still exist in people’s life.

## 2. The characteristics of the bamboo weaving technology

### 2.1 Process flow

The process of the bamboo weaving process is fine and complex, which requires carefulness and patience, and each process needs to invest a lot of energy. The process of bamboo weaving probably has the following processes: picking bamboo - preparing material - weaving - locking.

Step 1: Pick the bamboo. The knife used to cut bamboo is shaped like a curved hook. Bamboo picking is very exquisite, and the type of bamboo should be selected according to the woven objects. Small, tender bamboo is used to weave fine bamboo ware, and thick, old bamboo is used to weave large bamboo ware. Step 2: Prepare the materials. First, handle the selected bamboo with a knife, and soak, steam, bake, and smoke to enhance the softness and toughness of the bamboo slices, and finally, stain it. The dyeing method is mostly to boil the bamboo slices in the colored boiling water. Step 3: Knitting. Weaving the processed bamboo slices. The process of weaving can be rough: bottom, waist, shaping, and turning. Step 4: Lock the edge. With fine soft bamboo wire, insert, bundle, pull, tie, and lock the edge, make the edge of the bamboo more stable. This process can make the bamboo firm and compact, complete and delicate, beautiful and generous.

## 2.2 Craft techniques

Bamboo weaving techniques are diverse, with different cultural customs in different regions, and different craftsmen have different weaving techniques, forming a variety of patterns.” According to the different materials, are divided into” bamboo silk refined “and” bamboo thick woven.”<sup>[2]</sup> According to the difference of weaving techniques, it can be divided into “dense knitting” and “thin knitting”. The bamboo weaving techniques vary according to the needs, and all the weaving techniques are developed and extended from the most basic cross-weaving techniques. The common main weaving methods are human font weaving, cross weaving, twill weaving, hexagon hole weaving, and chrysanthemum bottom weaving. In addition to the techniques introduced above, bamboo weaving also adds dyeing and lacquer decoration technology, highlighting the aesthetic function of bamboo weaving, which can be anti-proof, and moisture-proof, moth-proof, but also reflects people’s unique aesthetic taste and life skills to adapt to the environment.

## 3. Bamboo woven furniture design elements

### 3.1 Functional elements

#### 3.1.1 Structure

Bamboo weaving, usually shown in the furniture structure in the form of a “body”, uses bamboo tenon connection, binding, wrapping, inlay, wrapping, cross, and other techniques, the structure is relatively simple. The leg structure of stool furniture connects two bamboo ends. In the parts of the furniture structure, tie it up and wrap it with bamboo strips to make it more firm.

#### 3.1.2 Form

“The basic form elements of furniture design include point, line, face, and body.”<sup>[3]</sup>The different properties of the material determine whether its morphological elements are the same.” Points” generally do not change the form of bamboo weaving as a separate form. The form of the “line” has a certain length in the furniture design, with a strong tension, but the plane volume is small. Many of the thread weaves with “line” form, woven by bamboo contempt, have a sense of extension and direction, giving people a light spiritual experience.” Face” has a certain plane volume sense in furniture design, according to the change of weaving pattern will be more specific quantity sense. According to different weaving techniques, bamboo contempt forms a plane and curved surface.” Body is formed by the aggregation of morphological elements such as points, lines, and surfaces.”<sup>[4]</sup> In the bamboo weaving process, the composition of the body can be facade weaving, and the “face” enclosure of plane weaving can also form the body. Generally speaking, the plane in bamboo weaving furniture, and facade combine to form a “body”.

### 3.2 Aesthetic elements

#### 3.2.1 Decorating

Bamboo, as a very environmentally friendly decorative material, itself has a decorative role, furniture external decoration is less, and the decoration part is also both structure and function. Different types of products have different weaving patterns, which are the overall decorative characteristics of bamboo weaving furniture in daily life. The common bamboo weaving decorative patterns are:

Through the empty surface, the bamboo is processed into narrow, thin bamboo strips, and bamboo pieces, through the arrangement and combination of vertical and horizontal oblique fork, forming many carved regular figures. There are representations of planes and surfaces. Full pavement shape, the bamboo is processed into filament, bamboo pieces, through the horizontal and vertical arrangement or oblique fork staggered combination, presenting a regular figure of relief effect. Line type, the bamboo is cut into bamboo strips, or with fine bamboo, using the characteristics of bamboo flexibility, bending, and circuitous to form a variety of patterns. These bamboo weaving patterns are combined with the furniture function and modeling, and have different functional effects in different parts, to achieve the unity of function and aesthetic appreciation.

#### 3.2.2 Color

The primary color of bamboo is mainly used, such as yellow and cyan systems, the purpose is to reduce costs, and at the same time to

bring people a fresh and natural aesthetic feeling. In modern furniture design to enhance aesthetic sex, a few part uses colors similar to bamboo for dyeing, red and black are the most common, and black is usually the ornament of a small area.

### 3.2.3 Emotion

In bamboo woven furniture, bamboo culture makes bamboo weaving have unique natural attributes, cultural connotations, and artistic characteristics. As well as the visual aesthetic elements composed of bamboo color and weaving patterns, the bamboo furniture can satisfy people's emotional experience and at the same time, make people experience the power of bamboo culture.

## 4. Application of bamboo weaving technology in furniture design

The design of bamboo woven furniture comes from life, and serves for life again. Most of the bamboo woven furniture is not decorated and processed, but originates from nature. The simple life philosophy contained in it is worth our development and inheritance.

### 4.1 People-oriented, function-oriented

Bamboo woven furniture should first meet the purpose of human use, folk handicraft person is the main group of bamboo woven furniture weaving, they are not only the creators of utensils, but also its users. Handicrafts should not only design product functions through life, but also weave them through handmade skills according to the designed scheme, which is the crystallization of human skills and wisdom, and also in line with the idea of people-oriented bamboo woven furniture. The appearance of most bamboo weaving furniture rarely imitates the natural form, and it is mostly based on simple geometric shapes based on practical functions. The design of a lot of modeling stems from the function, of making furniture more human nature. The craftsmen integrate their observation, perception, and experience of life into the bamboo woven furniture. so that they have the modeling consciousness with function as the core.

### 4.2 Decoration of nature and harmony

According to the needs of people, the furniture is simple. The craftsmen show the natural characteristics of bamboo in the utensils without complicated decoration, reflecting the pure, simple, and natural aesthetic concepts of the traditional people. Some adornment elements are practical, match with modelling photograph, reflecting the adornment style that gives natural harmony.

“In the decoration, the bamboo is very decorative. The composition form and weaving mode of bamboo weaving are often applied to furniture design with decorative elements, which are divided into surface decoration and decorative components”.<sup>[5]</sup> The most common form of bamboo weaving is plane, which is usually used on the surface of tables and stools. In addition to the advantages of material, there are also advantages of weaving technology and pattern, which enhance the effect of vision and touch. Bamboo material is tough, and soft, and can weave exquisite decorative components. While satisfying furniture to use stable sex, enhanced adornment effect again. If the local pattern when furniture weaves, the armrest of the chair.

### 4.3 Fusion of material and materials

In modern furniture design, the unique natural characteristics of bamboo weaving technology are integrated into the living environment of modern people, and the green and low-carbon characteristics of bamboo are integrated into modern design. The integration of materials and the environment integrates the bamboo culture with our lives. The better integration and application of bamboo weaving technology in modern furniture design also reflects the low-carbon lifestyle, provides rich creativity for the design of modern furniture, but also improves the quality of people's lives, and promotes people's lives towards the direction of environmental protection and healthy development.

## 5. Conclusion

Today's society is green, and the concept of environmental protection, the concept of green design has become the mainstream, bamboo weaving technology is in line with the characteristics of its green environmental protection, which provides an opportunity for its continuation. In addition, the bamboo culture has endowed the bamboo weaving process with deeper cultural value. The bamboo weaving process, is full of profound cultural feelings and also represents many thoughts and consciousnesses of the society, changing people's practice and aesthetics. Modern people's aesthetic concepts have gradually developed in many ways, people's appreciation ability has gradually become

higher, and technology has also improved a lot, which makes bamboo weaving, a traditional and strange craft, gradually stepping into a diversified space. In the process of real development, it has different characteristics in different histories and cultures. I believe that the bamboo weaving technology will not stop the pace of development, and will have more artistic vitality.

## References

- [1] Feng Yi. Chinese Traditional Bamboo Furniture Research [D]. Sichuan: Southwest Jiaotong University, 2008.
- [2] Yang Wanying. Research on modern inheritance and Product innovation of Traditional bamboo weaving technology in China [D]. Wuxi: Jiangnan University, 2013.
- [3] Zeng Weixia. Research on the application of Chinese bamboo weaving in furniture design [D]. Hunan: Central South University of Forestry and Technology, 2014.
- [4] Yang Yanli. Analysis on the innovative strategy of traditional bamboo weaving technology in modern furniture design [J]. Industrial Design, 2020.
- [5] Li Penghui. Research on the design of household products integrating with the bamboo weaving technology in western Hunan [D]. Guilin University of Technology, 2023.

# An Experimental Discussion on the Shaping of Confucian Business Spirit by The Great Learning

Lang Jie Jia Yang

Sichuan Yakang (Luxi) Expressway Company Limited, Chengdu 610000, China.

---

**Abstract:** This paper argues that the great learning contains profound management wisdom, and under the influence of this wisdom, the unique management characteristics of Confucian businessmen are formed, that is, self-management of cultivation and prudence and affectionate team management. Finally, it focuses on the contemporary value of Confucian business spirit, which is mainly reflected in the construction of the framework of “heaven and earth, group and self”, i.e., balancing the three benefits (economic, social and ecological benefits), handling the three relationships (the relationship between the pursuit of economic benefits and the regulation of business activities, the relationship between the utilization of natural resources and the protection of natural resources, and the relationship between the entrepreneur’s own ecological construction and the construction of the natural ecological construction), and attaining a realm (“stopping at the highest goodness”, as mentioned in the book of “The Great Learning”).

**Keywords:** The great learning; Ren; Economic ethics; Management thought; Confucian business

---

At present, China has entered a new era of socialism with Chinese characteristics, and the main contradiction in society has changed to the contradiction between the people’s growing needs for a better life and unbalanced and insufficient development. Nearly forty years of reform and opening up has brought particularly fruitful results, directly sending China into the world’s second largest economy, but in the specific economic practices there are still more “unbalanced and inadequate” phenomenon, and gradually become one of the main factors hindering the pursuit of a better life of the general public.

## 1. Examination of the historical origins of Confucian merchants and their spirits

Since the 1980s, mainly due to the special experience of economic growth in East Asia (including Japan, Taiwan, China, Hong Kong, China, South Korea and Singapore), many sociologists and economists have begun to notice the positive utility of Confucian ethics. The economic prosperity of the so-called East Asian Confucian Cultural Circle countries and regions, especially Mainland China with thousands of years of Confucian cultural tradition, has become the second largest economy in the world after nearly forty years of reform and opening up. People have studied the essence of the economic phenomenon of “unique scenery” in the world and put forward some research topics such as “Confucian business” and “Confucian business spirit”, and the research and discussion centered around these topics have been very successful. The research and discussion around these topics are in the ascendant.

### 1.1 Meaning of Confucianism and its Spirit

Before clarifying Confucian merchants and their spirit, I think we should ask two questions: Are Confucian merchants businessmen or Confucian scholars? Is his behavior in the businessman or in the Confucian? In fact, the center of the problem is the main body of Confucian merchants, is it a merchant or a Confucian? With the current literature and related research, it is difficult to confirm the exact origin of the term “Confucian businessman”, and the academic community is also divided on the definition of “Confucian businessman”, so far there is no uniform statement.

### 1.2 Historical lineage and developmental evolution of Confucian merchants and their spirits

After sorting out the definition of Confucian merchants and their spirit, we should go back to history to explore the origin. As Mr. Yang Liansheng said in his preface to *The Religious Ethics of Modern China and the Spirit of Merchants* by Prof. Yu Yingshi, first of all, we have to go back to the “original merchants”. According to the literature, such as the pre-Qin literature in the “Guanzi”, “Strategy of the Warring States”, etc., and does not appear directly “Confucian businessmen” two words. However, we can find from the “Shiji - Cargo Shares Biogra-

phy” after the pre-Qin period that Sima Qian, according to the merchants’ daily transportation, For example, the “Three Great Sages of Cargo Sharing” - Tao Zhu Gong (Fan Li), Zigong (Duanmu Zhi), and Bai Gui - made the distinction and categorization of “honest merchants”, “good merchants”, “greedy merchants”, etc. For example, he pointed out that “greedy merchants are three, and good merchants are five”, which relates to the moral and ethical spirit of merchants, and this is a very important historical clue for the later use of the term “Confucianism” to describe the term “merchants”.

## **2. The Shaping of Confucian Business Spirit by the Economic Ethics Thought of the great learning**

In Principles of Ethical Economics, Peter Koslowski says that economic ethics, as a moral doctrine of economic behavior, supplements the theory of possessions and the quality of value with formal rules as well as the ideal of universalization and the ideal of coordination.

Indeed, when economics and ethics are merged and talked about together, it inevitably involves the moral cognition and moral choices of human beings in economic activities. In fact, economics and ethics are the relationship between desire and morality. For example, the famous economist Adam Smith wrote both *The Wealth of Nations* and *The Theory of Moral Sentiments*, and some scholars have even argued that Adam Smith was not an economist but a moral scholar. Eiichi Shibusawa, the father of Japanese industrialists, developed the concept of “Scholar’s Soul and Business Talent” and wrote “*The Analects of Confucius and the Abacus*”, using the Analects as his bible for doing business.

### **2.1 The main contents of the economic ethical thought of the great learning**

The Great Learning said, “There is a way to generate wealth; those who give birth to it are many, those who eat it are few, those who work for it are sick, those who use it are comfortable, and then the wealth is always sufficient.” This passage has at least three layers of meaning.

The first level of meaning is economic, advocating “joyful living and low desire” and “open source of income and reduce expenditure”. In the production of social wealth, people should be enthusiastic and “over-ambitious”, the more people produce, the better; in the enjoyment of social wealth, people should be humble and fearful of avoiding each other, the fewer people enjoy, the better. When opening up sources of wealth, the higher the efficiency, the better; when enjoying social wealth, pay attention to economize, the slower the better. If this is the case, there will be no worry about the lack of wealth.

The second level of meaning is the ethical level: “life” should be “many”, “desire” should be “few”, “work” should be “fast”, and “use” should be “comfortable”. “To be” should be “fast” and “to use” should be “comfortable”. For production to pay, from the heart to produce love, and become a kind of behavioral self-awareness; for enjoyment to ask for, clear mindedness before others, and form a kind of consciousness self-awareness. These concepts are the core of the ethical thinking of Confucianism, especially the great learning, which aims to form an interpersonal relationship in which “subjectively I am all for one, and objectively all for me”.

The third level of meaning is philosophical, that is, “there is a way to make money”. What is the “way” of “generating wealth”? “Those who generate it are many, those who eat it are few, those who work for it are fast, and those who use it are comfortable”.

#### *2.1.1 The concept of wealth distribution in which wealth is dispersed and gathered by the people*

The great learning said: “Therefore, when wealth is gathered, the people are dispersed. If the wealth is scattered, then the people will gather. “If the above “physical relationship” between virtue and property is a more conceptualized category, then the “dispersal of wealth and the gathering of people” is directly related to the actual distribution of property after acquisition. In fact, The Great Learning uses dialectical thinking to explain the “relationship between wealth and people” involved in the distribution of property. When wealth is gathered, people are dispersed; when wealth is dispersed, people are gathered; one yin and one yang, one and one relaxation, just as Zhang Shuo, a famous minister of the Tang Dynasty, said in the book “Qian Ben Cao”, “One accumulation and one dispersal is called the Way”. In fact, we all know the reasoning, a person to get more property, it also means that he possesses more resources than others, more out of that part of the resources is in fact plundering others “indicators”, others certainly alienate him. However, when he is willing to share his resources with others, his relationship with them will naturally be strong. The result of the dispersal of wealth is that the people will gather together and become numerous,



and “if you gain the many, you gain the state”, while the result of the gathering of wealth is that the people will disperse, and the consequence is that “if you yag the many, you yag the state”.

#### *2.1.2 A paradoxical view of the causes and consequences of wealth*

The great learning said, “Therefore, those who say it is perverse to go out are also perverse to go in; those who say it is perverse to go in are also perverse to go out.”The word “disobedient” here means contrary to, and against, the Way. The great learning teaches that if you utter words that are contrary to the Way, then you will suffer the same retribution because of them; and that wealth amassed by means that are contrary to the Way will eventually be paid back in an unexpected way. Sow melon and you get melon, sow beans and you get beans, “The so-called “Ping Wei” in the rule of his country, on the old and the people are filial piety, on the elder and the people are younger, on the elder and the people are younger, on the orphans and the people are not doubled, that is why the gentleman has a pros and cons way.” If the king emphasizes the way of filial piety and fraternal duty and respects the old and the elders, then the people will also promote the way of filial piety and fraternal duty, and if the king cares for the orphans and widows, then the people will follow suit to care for them, and then this will not violate human ethics and moral principles. This reasoning is not only suitable for the way of governance, also suitable for the way of business, it reflects a kind of upward and downward effect of cause and effect relationship, just on the paradoxical into the paradoxical out of the counter-evidence. And “there is no one who is good at benevolence but not good at righteousness, and there is no one who is good at righteousness but not at the end of his business”, which precisely shows that cause and effect will not be reversed, and explains once again the wealth and cause and effect view of the “Da Xue” which is contrary to what is in and contrary to what is out.

### **3. Contemporary Value of Confucian Business Spirit**

In essence, the concept of Confucian business is still based on the word “business”, only that Confucian businessmen take the spirit of traditional Chinese culture, with Confucianism as the main body, as their soul in their business practices. Of course, the source of this soul can be found directly in the economic and ethical thinking and management wisdom contained in The Great Learning.

#### **3.1 “Virtue” and “Cultivation” to improve character and purify the air of the business market**

With the reform and opening up of mainland China for nearly 40 years, the socialist market economy has developed to a new level and a series of brilliant achievements have been made. At the same time, we can still find a number of unscrupulous businessmen who are profit-oriented and will do anything to obtain high profits. In commercial activities, some business operators have disordered values, ethical and moral failures, lack of rational behavior, moral slippage, credibility crisis. The infamous “trichlorocyanine incident”, “gutter oil incident” and other typical cases are representative of the endless scandals in business operations. This kind of bottomless money worship directly affects the interests of consumers, deeply pollutes the air of the commercial market, and seriously disrupts the healthy development of the economy and society as a whole.

#### **3.2 “Economic and social welfare” and the promotion of social harmony and stability**

“To help the people through the world” is an important element of the spirit of Confucianism and commerce, and the purpose of Confucian merchants’ diligence in business is to realize the ambition of “helping the people through the world”. Take Zigong, the originator of the Confucian businessman, for example, although his “family is tired of thousands of dollars”, but “rich but not proud”, and “rich but good manners”, often help the poor and needy, such as subsidizing Confucius to travel around the world and ransom the slaves of the state of Lu. He often helped the poor and the needy, such as subsidizing Confucius to travel around the world and redeeming slaves in Lu. The ideal of “making the world a better place for the people” in the spirit of Confucianism, and the concept of righteousness and profitability of Confucian businessmen, which is “gained from society and used in society”, are conducive to the formation of new Confucian businessmen and the creation of a responsible group, which is conducive to the harmonious development of “righteousness” and “profit” in a balanced manner. Responsible group, conducive to the creation of a “warm-hearted public welfare” climate, conducive to “righteousness” and “profit” in a balanced and harmonious development. The spirit of Confucian businessmen emphasizes that in the process of pursuing benefits, businessmen should take “righteousness” as the criterion, and after obtaining benefits, they should maximize the return to society and realize social values,

such as strengthening the country and enriching the people, donating funds to promote education and helping the poor and the weak, etc. In this way, it helps contemporary people to go beyond the boundaries of “righteousness” and “profit”. In this way, it helps people of today to transcend their own narrow economic interests and develop the concept of common prosperity, and through “giving to the people”, the people of the world are able to live and work in peace and contentment in their own way.

## Summary

Starting from the conceptual analysis of Confucian merchants and their spirit as well as the historical sorting, this paper argues that Confucian merchants mainly refer to those groups who consciously combine the traditional Chinese culture centered on Confucianism with their business practices in the countries and regions of the East Asian Confucian Cultural Circle, and who practice Confucianism and promote Confucianism with their own behavior. At the same time, Confucian merchants and their spirit are a group of At the same time, Confucian business and its spirit is the result of a long period of formation, roughly through the pre-Qin period of the germ stage - the Ming and Qing period of the molding stage - the modern period of innovation and development of the stage of three phases.

## Acknowledgments

Three years are like a white horse passing by, and we are coming to the end of the program in a flash. I would like to express my sincere thanks to my supervisor, Prof. Duan Jifu, for preaching, teaching and explaining to me during the three years of graduate school, which has inspired me academically. Especially when I finished this thesis, from the preliminary opening report, to the mid-term testing, to the later revision and polishing, Mr. Duan could take time out of his busy schedule to carefully read my thesis, and every time he pointed out the key problems at the critical time and gave me valuable advice, which is of great significance in guiding this thesis. At the same time, I would also like to thank my friends in the class of 2015 majoring in Chinese Philosophy who have been struggling with me in the “research path” for the past three years, and I hope that we can go farther and farther in our respective paths in the end.

## References

- [1] Zhou Shengchun, Yang Ying. 2010. Confucian Businessmen and the Spirit of Confucian Businessmen in History [J]. Research on Chinese Economic History, 4.
- [2] [US] Du Weiming. 2013. Du Weiming Interview [J]. China Philanthropist, 7.
- [3] [US] Du Weiming. 2012. The Way of Confucian Business [J]. Idea and New Knowledge, 2.

# Four-Corner Model: A New Application of The Interpretive Theory in English-Chinese Written Translation

Wenyang Pang

Shaaxi University of Science and Technology, College of Culture and Education, Xi'an 710016, China.

---

**Abstract:** Slow translation speed and the difficulty of translating long and complex sentences are the problems that translators often face in the practice of English-Chinese written translation. By analyzing the process of rapid interpretation by interpreters, which is often considered to be guided by the Interpretive Theory, this article attempts to obtain suitable methods from the interpreting process to improve the speed and quality of written translation. This paper constructs a “four-corner model” for English-Chinese written translation after the discussion of the Interpretive Theory, especially its “triangular model of interpretation”. Through some training, the “four-corner model” can effectively improve the speed and quality of English-Chinese written translation.

**Keywords:** The Interpretive Theory; Interpretation; Triangular model of interpretation; Written translation; A “four-corner model” for translation

---

Since translation was professionally divided into oral interpretation and written translation, the theories of the two seem to have developed in different ways. Some researchers believe that translation is essentially the same, so they studied the process of translation as a whole and didn't distinguish oral interpretation from written translation when discussing translation methods. Some researchers have developed specialized interpretation theories according to their own practice, such as Danica Seleskovitch and Marianne Lederer. However, few researchers have applied specific interpretation theories to the study of translation. The author of this article has asked interpreters for quick translation methods, so she turns her attention to the Interpretive Theory when solving some problems in the process of written translation.

This article begins with a discussion of some key points of the Interpretive Theory, including its summary of the essence of translation and of the process of interpretation, the “triangular model of interpretation”. Based on this, the author puts forward some enlightenment from the Interpretive Theory for the translation process (mainly Chinese-English translation). Then the article constructs a model suitable for the translation process, namely the “four-corner model”. Finally, some examples of the application of the “four-corners model” in dealing with specific problems of translation are given.

## 1. The Interpretive Theory

Different from the dominant School of Functional Linguistics at that time, Seleskovitch chose interpretation process as the object of her observation and research. She proposed a strict distinction between language and meaning, and focused her research on demonstrating the generation of meaning between two languages, that is, the generation of meaning after understanding the source language. When re-expressing in the target language, the sentences or expression we choose is still based on meaning rather than the form of source language.

### 1.1 Nature and Purpose of Translation

Translation is a communicative behavior and its purpose is to convey communicative meaning.

The kernel of Interpretive Theory is the distinction between linguistic meaning and non-verbal sense. What the translator wants to convey is not the meaning of linguistic signs, but the non-verbal sense expressed by the speaker in his speech. That is to say, the essence of meaning is the “sense” conveyed by communicators through language symbols, rather than the meaning of language symbols themselves (Danica Seleskovitch & Marianne Lederer, 1984).

Interpretive theory holds that what a translator or interpreter wants to translate is not language symbols, but the meaning that the language symbols want to express. That is to say, the essence of translation is the exchange and transformation of meaning, which is the same both in the process of interpretation and translation. This is the basis on which an interpretation theory can be used to study the written translation process.

In fact, in the early period, the Interpretive Theory focused on the study of interpretation, especially the process of conference simultaneous interpretation. However, with the deepening of the research, the researchers themselves have extended the scope of application of their theory to various forms of meaning translation, including written translation and sign language translation.

## 1.2 Deverbalization

Anyone can observe the evanescence of oral statements. Interpreters remember the bulk of what is said but forget almost all the actual words used to say it. This fact is patently obvious during a speech: the signs of the discourse disappear with the sound of the voice but the addressees – and the interpreter – keep a deverbalized memory, an awareness, of the ideas or facts evoked (Marianne Lederer, 1994).

Deverbalization, then, is a cognitive process: as the signs of a discourse disappear, sensorial data, that is to say, the meaning conveyed by the discourse, become bits of knowledge divested of their concrete shape. The victory of interpreters over the evanescence of words has allowed the close study of an important phenomenon of language behaviour: deverbalized sense is transmitted from speakers to listeners, it arises out of words but is not to be confused with them (Marianne Lederer, 1994).

The Interpretive Theory holds that each language is an external form, and what translators or interpreters try to translate is the meaning contained in this “language shell”. The interpreter needs to grasp the meaning expressed by the speaker within a short time after hearing the content of the sentence, so it is less affected by the form of language. The translator understands and translates the meaning while looking at the source text, and the source text does not “disappear”, so the linguistic form of the source language will continuously and intuitively affect the translator’s obtaining of the meaning of the original text.

## 1.3 The process of oral interpretation: the triangular model

The theory of the Interpretive school attaches great importance to the study of the translation process. According to the theory, in interpreting, the interpreter actually has to go through three stages before transforming the speaker’s words into words that can be understood by the audience in another language:

Step1: Listen clearly to the language symbols used to express the content of thought. Through analysis and understanding, the language phenomenon expressed by these symbols is clarified. Find out what the symbols are saying. This stage is called “interpretation or exegesis of discourse” (Heping Liu, 2011).

Step2: Immediately and consciously forget the structure of these language signs in order to remember only the content of the thought expressed, that is, the cognitive and emotional meaning produced by the language signs. This stage is known as deverbalization.

Step3: Make new sentences with symbols in another language, and make these sentences conform to the following two requirements: first, they should express the whole content of the original sentences, and second, they should be easy to understand (Lederer, 2003). This stage is the “reformulation” of primitive information content.

These three steps of interpretation can be formulated in this triangular flow chart below:

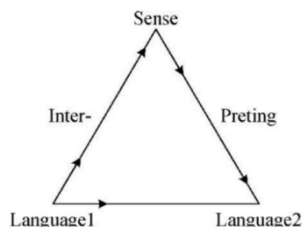

## 2. Some Enlightenment on the Interpretive Theory

After discussing the core points of the Interpretive Theory, the author puts forward some enlightenment which are applicable to written translation practice. In general, each language has its own specific form, or “shell”, which plays a slightly different role in the interpretation and translation process.

## 2.1 Different Characteristics of Chinese and English: Different Shell

The basis of good translation undoubtedly lies in understanding the linguistic characteristics of the source language and the target language. And Chinese and English, two languages derived from two different cultural, share so many differences in various aspects.

The syntactic characteristics of English and other European languages are very much in line with the Western way of thinking, which focuses on logic and reason. Rationalism emphasizes logical reasoning and pays attention to formal argumentation, which is manifested in English, that is, paying attention to the disclosure of form, rigor in the formation of structure and complete form. English sentences, whose grammar is dominant, adhere to the formal structure and pay great attention to form to express meaning, mainly hypo-tactic. Hypotaxis uses the change of form and the logic-grammatical connectors to rigorously expresses the meaning of the speaker (Shuneng Lian, 2010).

In sharp contrast, Chinese sentences seldom use or even do not use formal connection means, and pay attention to implicit coherence. Chinese, which pays attention to time and order of things as well as its function and meaning, is parataxis. There is no formal grammatical distinction in Chinese, and all useless appendages are discarded, so that sentences correspond closely to the order of thought (Meskill, John, 1973).

These two distinct linguistic characteristics of Chinese and English are exactly the difficulties for translators to deal with Chinese-English translation. Unfamiliarity with one of these two “shells” often leads translators to either spend too much time organizing the target language or to output an insufficiently native target language.

## 2.2 Deverbalization Differs in Chinese and English

The factor of language “shell”, or deverbalization, plays a different role in the process of interpretation and translation. Perhaps the biggest difference is the immediacy of oral interpretation.

The distinguishing feature of interpretation from translation is the immediacy of its work. That is to say, the interpreter will interpret the target language in spoken form at the moment the speaker has just finished speaking. It also involves many cognitive procedures, neural processing, listening comprehension of source language, acquisition and memory of meaning, translation and expression of target language, etc (Weihua Lai, 2012). The process sounds complicated, but at least in terms of deverbalization, interpretation is easier than translation-- because the language shell “disappears” the moment the speaker finishes speaking, leaving only the sense information captured by the interpreter.

It is relatively difficult for the translator to finish deverbalization, because the form of translation determines that the shell of the source language is always in front of the translator, which not only affects the translator’s obtaining of the source text’s meaning, but also restricts the translator’s process of expressing the meaning of the source language into the target language.

## 3. Four-corner model: Process of Written Translation Based on the Interpretive Theory

The key to solving the difficulty of understanding and re-expressing source language information in written translation is to realize rapid expression by strengthening the linguistic shell of the source language and the target language respectively, which is precisely the idea provided by the Interpretive Theory. Combined with the “triangle model” of the Interpretive Theory, the author analyzes and proposes a similar “four-corner model of translation”, which can realize the rapid translation of complex sentences or clauses in translation by summarizing the shell of the target language (in this case, Chinese) into some formulaic formulations.

Similar to the “interpretation triangle model”, the “written translation four-corners model” can be summarized as the following:

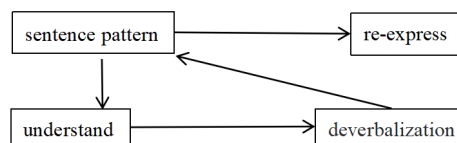

To translate long sentences in an oral interpretation way, it is necessary to understand the original sentence in combination with the sentence pattern, and then quickly break away from the shell of the original language, and use the 2 or 3 simple sentences to re-express the original sentence. The most important point here is to understand the original sentence structure - and then leave the source language shell -

and re-express it in multiple simple sentences. Never spend too much time agonizing over which sentence structure to rephrase it in, just use multiple simple sentences.

Here takes the case of attributive clauses as an example:

The biggest reductions are in the area at the back of the cortex where information from the retina is processed and interpreted, and in the “default-mode” network, a piece of neural circuitry distributed between three different cortical areas, which is associated with daydreaming, mind-wandering and thinking about the self and others.

The reason why translators find long sentences difficult to translate is that they stick too closely to the original form. When we translate this sentence in an oral interpretive way, things may become easier. The first step is to fully comprehend the sentence combined with the original sentence pattern: ① biggest reductions...at the back of the cortex ② the back of the cortex...information from retina...processed and interpreted here. After we get the meaning, translation marched on to second step, that is to focus on the meaning and leave out the sentence pattern. Then step three, go to the new Chinese sentence pattern, never spend too much time thinking in what the order those meanings will be re-expressed, just apart the original attributive clause into two simple sentences. Do not waste time in gathering up your sentence like: The most atrophied area is the area located in the posterior part of the cerebral cortex that processes and reads information from the retina. Finally, step four, re-express your target language sentence out:

The most atrophy is in the posterior part of the cerebral cortex, which processes and reads information from the retina, and in the “default mode” network, a section of neural circuits in three different areas of the cerebral cortex that are associated with daydreaming, wandering, and thinking about self and others.

This approach can not be used in the long-term plan of improving the translator’s bilingual ability, but it is quite suitable for dealing with time-limited tasks such as exams.

Analyze the fixed sentence patterns applicable to different English clauses when translating into Chinese, summarize a set of effective Chinese “language shell”, and then in translation practice, use the “translation four-corners model” to quickly translate and transform can greatly increase the speed and effectively improve the efficiency of translation. Although the “translation four-corners model” does not seem to be a way to improve translation ability, through long-term practice, translators will have a better understanding of bilingualism, and ultimately improve their translation ability.

## References

- [1] Danica Seleskovitch & Marianne Lederer. *Interpreting for International Conferences: Problems of Language and Communication* [M]. Trans. D. Stephanie. McMillan. Washington: Pen and Booth, 1984 .
- [2] Marianne Lederer. *La traduction Aujourd’hui: le ModèLe Interpretatif* [M]. Paris: Hachette, 1994.
- [3] Marianne Lederer. *Translation : The Interpretive Model* [M]. Trans. Ninon Larche. Manchester: St. Jerome Publishing, 2003 .
- [4] Meskill, John. *An introduction to Chinese Civilization*. New York: Columbia University Press.
- [5] Weihua Lai. *Philosophic Speculation on the Research of Interpreting* [J], *Journal of Nanchang University*, 2012, 43(6)
- [6] Shuneng Lian. *English-Chinese Comparative Studies* [M], Lian Shuneng, Beijing: Higher Education Press, 2010.
- [7] Heping Liu. *Interpretation and Translation Theory of the Ideological School* [M], Liu Heping, Beijing: China Foreign Translation Company, 2011.

Author’s introduction: Wenyang Pang (1987-), female, Han nationality, Shanxi Datong, Master, Shaanxi University of Science and Technology, College of Culture and Education, student, research direction: scientific and technological translation.

# The Necessity and Feasibility of Implanting Professional Expansion Courses

## —Taking the Talent Cultivation of Art and Design Disciplines in Colleges as an Example

Yani Yang

University of Sanya, Hainan 572000, China.

---

**Abstract:** In the course of the 14th Five-Year Plan, the Ministry of Education highlights in the work plan of 2021 that we should promote the quality and innovative development of higher education, which will facilitate the continuous improvement of high-quality development system of higher education and the cultivation quality of urgently-needed talents, the effective optimization of the disciplines and specialties structure of higher institutions, the increase of the high-quality resources supply for higher education, the further advancement of “double first-class” initiative and expanding employment of college graduates. In respond to this, this paper focuses on the cultivation strategy of innovative and compound talents of art design discipline in higher institutions, views from the talents cultivation standard of higher institutions and social demands for talents, and analyzes the problems identified in the talents training program of art design discipline in the contemporary higher institutions in terms of the structural restrictions of the current talents training program, the psychological restraints of students themselves and the position limitations of corporate demands for talents to propose the concept of extended specialized courses and highlight the necessity of its introduction. Based on the experience of talent cultivation in contemporary art design discipline, this paper puts forward that a “person” should be regarded as an independent individual with differences in the process of talent cultivation, integrating the cultivation elements of knowledge, individual and society into an organic closed loop with mutual constraints and complements. Moreover, this paper discusses the feasibility of the introduction of extended specialized courses from the perspective of the passive input and active exploration mode of curriculum and its effective association with the corporate talent mechanism. The paper explores from the implementation approach of introducing extended specialized courses into the talents training program from aspects of curriculum connections, supervisor accountability system and graduation work, and further expounds the necessity and feasibility of extended specialized courses introduction in the talent training program of art design discipline in higher institutions.

**Keywords:** Art design; Talents training; Extended professional curriculum

---

## 1. Problems of Art Design Education in Contemporary Higher Institutions

### 1.1 Constrained “Hierarchy” and “Forms”

The traditional curriculum system structure pattern consists of “hierarchical composition”, that is, the common fundamental course, the specialized fundamental course, the specialized course, the interdisciplinary course, as well as “formal composition”, that is, the compulsory course, the elective course with limited varieties, the optional elective course. On this basis, different higher institutions in different regions will make appropriate adjustments according to their school-running concepts and characteristics. At the same time, the personnel training program which is more in line with the needs of the current society is formulated based on the educational policies of the Ministry of Education of China issued in different times, and such way is undoubtedly scientific, systematic and mobile. However, in the course of its implementation, there are still a number of problems such as the students’ lack of practical ability, the mismatching of concept and technique, the lack of dynamic development of thinking ability, the lack of adaptability of teaching mode and the lack of team cooperation ability. Especially for such a comprehensive interdisciplinary discipline as art and design, where the cutting-edge knowledge is rapidly updated, the visual requirements is constantly innovated, and the hardware carrier is iterated in an innovative manner, it is necessary to constantly optimize the

curriculum system with a view to making it better meet the needs of social enterprises in this changing and developing times.

## **1.2 Self-handicapping Ability**

Although there is a conscious effort in higher institution education to plan the talent training path for students at the early stage of their professional learning, and even encourage students to make progress on their own with the “course map” as the blueprint, students are still treated as passive receptacles in the process of tailoring curriculum, especially elective courses, which only focuses on the existing ability of students instead of exploring their potential. The self-handicapping mentality leads to the neglect of the importance of “ability” enhancement in the process of pursuing “knowledge”, and it also ignores the exploration of possibilities in the development of one’s abilities and career planning upon the mastery of current knowledge system. Such issue of “self-handicapping” becomes overlooked in the discipline training system planning.

## **1.3 “Imperfection” of Talent Development**

The requirements for art design positions for fresh graduates on Zhaopin.com, BOSS Zhipin.com, 58 Tongcheng.com and other mainstream recruitment websites in China can be concluded in three main aspects:

- (1) Focusing on the quality and quantity of art and design works;
- (2) Requirements for technical skills and proficiency in professional software;
- (3) Decent personality and work attitude, etc.

Meanwhile, primary technical positions concerning the employment of software and techniques like art designer, design assistant, designer, draughtsman and merchandiser ,are in the majority, while positions related to creative thinking like planning, corporate image, brand promotion are less. In the professional education, higher institutions have laid excessive emphasis on enhancing students’ mastery of technology, methods and skills according to the requirements of enterprises, but neglected the cultivation of creative thinking ability and cultural ideas.

## **2. Feasibility of the Introduction of the Extended Specialized Course**

Curriculum system aims to design the direction and the nurturing function of the courses as required by the society, with the talent training goal and the specification as the main body. There are three aspects that should be taken into consideration: first, the necessity of social needs, second, the imperfection of human development, third, the overall status of knowledge, which account for the target sources of higher education, and also the three basic sources of knowledge, the individual and society. Once the goal of the training program is set, it will determine the path and direction of the curriculum construction. The extended specialized course belongs to the third category in the professional curriculum dimension, which is distinguished from the professional compulsory course and professional elective course, and is the extension and supplement of the professional course, as well as the deep excavation of students’ personal characteristics and interests in the disciplinary training system of higher institutions.

### **2.1 Forming a Closed Loop of the Three Elements: Knowledge, Individual and Society**

The three basic sources of the aforementioned higher education goal are knowledge, individual and society. Among them, the nature of imperfection of human development, emphasized in the basic source of “individual”, is the necessary supplement and important basis for the construction of talent training program. Students who have completed their higher education courses will meet the needs of social enterprises, however the most important factor in this loop is the individual “person”, who, even if receiving the same information, will demonstrate differentiated models of output. Therefore, in addition to the study path of the elective and compulsory course, the extended specialized course is incorporated to allow students to seek knowledge that is distinct from and can be integrated with their major while receiving input knowledge in a unified manner.

### **2.2 Extensive Construction of Diversified Curriculum System**

Due to the high requirements and comprehensive nature of the art design discipline, the formulation of the curriculum system tends



to be diversified, which is evident in the establishment of courses such as design psychology, art design communication, design aesthetics, design behavior, etc. It indicates that many domestic higher institutions in China are aware of the close relationship between the art design discipline and other disciplines in the establishment of the training system of art design discipline. In recent years, as the new media technology continuously innovates, the carriers of art design visualization have become more and more abundant, and the combination of resources between platforms has made many emerging industries subdivided in different fields. Before scholars have had time to delve deeply into new industries, students can reach out and learn about those latest information through channels such as the Internet. How to understand those new things based on the existing cognition and the underlying logic in an effort to explore the possibility of one's development and widen the boundaries of professional knowledge, has become an important basis for the establishment of the extended specialized course.

### **2.3 From Passive Input to Active Exploration**

“From passive input to active exploration” is one of the important goals in the talent training system of many higher institutions in China, and “the path of guiding students’ active exploration” has become a hotly debated topic in the recent innovation of training programs. In regard to the extended course, students can combine their individual characteristics with their major under the guidance of the supervisor to produce the work concerning the limited themes, such as handicrafts, food, Vlog, language expression, religious beliefs, etc., which may not seem to be related to the major, but can be integrated with professional knowledge in a theme-based manner to create works individually or jointly. The extended specialized course can contribute to the enlightenment of innovation and entrepreneurship on one hand, and is conducive to the active exploration to students’ ability and the output of comprehensive talents on the other hand.

### **2.4 Linkage with Enterprise Talent Mechanism**

As for the enterprise’s selection process of talents, the work output in the extended specialized course will help the enterprises to gain a deep understanding of the talents, including their ability, personality, expertise, job preferences and other factors can not be seen directly from the resume or portfolio, and the category of the work can be also regarded as an important basis for selection. At the same time, students can demonstrate their targeted job search intentions based on their precise positioning of their capabilities. The establishment of extended specialized course provides an important reference in the school-enterprise cooperation concerning talent output.

## **3. Primary Exploration of the Method of Incorporating the Extended Specialized Course**

### **3.1 Linkage with Specialized Compulsory Course and Elective Course**

The establishment of the extended specialized course is different from the specialized compulsory course and elective course, but the effect of the course is closely related to the existence of the elective course and the compulsory course. The specialized compulsory course is designed for the cultivation of students’ individual accomplishment and common professional ability, and the specialized elective course is designed for developing students’ preference and individuality in the professional planning, while the extended specialized course aims to mine more possibilities in the development of commonality and individuality at the same time, which is more open and more independent. Therefore, the incorporation of extended specialized course in the initial stage of students’ professional education in higher institutions will contribute to nurturing students’ individual qualities and professional abilities, and exploring students’ individual capabilities and personalized needs with the assistance of the limited elective courses, which will allow students to develop a relatively holistic sense of career planning at the beginning of their professional studies.

### **3.2 Supervisor Accountability System and the Mode of Curriculum Teaching and Management**

The extended specialized course is taught in a different way from traditional courses. In terms of the course supervisors, the pre-preparation for teaching materials and other related stuff takes up a smaller proportion of the course. Instead, the course focuses more on the exploration of individual students’ abilities, interests and personality development. At the same time, the comprehensive quality of the supervisors is required to be high, which should be embodied in their understanding of various disciplines of art design, the inclusion of new things,

sensitivity to cutting-edge information and technology, interdisciplinary knowledge reserves and good organization and coordination ability. Drawing on the flipped classroom lecture format, research, student peer evaluation, group discussion, teacher-student dialogue, thematic discussion, and inducing-mode questioning are the main methods, supplemented by the supervisor's explanation. Supervisor accountability system is adopted in the teaching and management of the course, encouraging student-teacher two-way selection and limiting the number of students enrolled in the course with a view to improving teaching quality and ensuring deeper communication between students and teachers.

In regard to students, the traditional teaching method prevents them from fully expressing their ideas in the fixed time, and makes it difficult to combine the personal characteristics with the professional field more flexibly. However, the extended specialized course finds a way out of the relatively serious atmosphere in the traditional classroom, where the methods of "round table", "impromptu group" and "free speech" are utilized for teaching to create an orderly and relaxed atmosphere. In this way, the teaching purpose of organically combining students' personal characteristics, interests and professional knowledge can be achieved.

### 3.3 Linkage with the Graduation Work

According to the disciplinary training program of Chinese higher institutions, the themes of graduation design/thesis are usually determined in the second semester of the third year. The incorporation of the extended specialized course can inspire students to identify the direction of their research in advance in the four-year academic study, to study the courses in a more targeted way after communicating and discussing with the supervisor, and become more aware of their research direction in the process of data collection, industry research, social practice and professional internship. The graduation design of art design discipline is unique in that it sets dual requirements for students' professional technique utilization and creative design thinking ability. The professional technique utilization can not be separated from technical research and repeated training, while creative thinking ability can be manifested by a kind of "personal consciousness" on basis of the study of various courses, which can be cultivated consciously in the extended specialized course at the early stage of graduation thesis's theme determination.

## 4. Conclusion

Considering the goal of continuous improvement of higher education's high quality development system and the problems confronted by the educational work, the modern art design discipline in China, after more than thirty years of development, has unveiled the necessity of incorporating the extended specialized course. Although the factors that determine the quality of personnel training involve with many aspects, the purpose of talent training still lies in broadening the boundary of students' knowledge, enriching their professional abilities and improving the quality of higher institutions' talent output. The exploration of extended specialized course is still at its initial stage, and the implementation of the relevant courses needs to be constantly improved in the changing market economy, however it is still necessary to incorporate the extended specialized course into the cultivation of art talents.

## References

- [1] Hu Bicheng. Modernization of University Curriculum System. [M]. Changsha: Hunan University Press, 2007:19-20.
  - [2] Wang Weilian. Higher Education [M]. Fuzhou: Fuzhou Education Press. 2001.159-169.
  - [3] Yuan Jiong. Research on the Connotation of Cultural Innovation System and the Institutional Choice of Cultural System Innovation [D]. Master's thesis, China Art Academy, 2010.
  - [4] Li Yi, et al. Reform and Practice of Elective Extension Curriculum System for Clinical Medicine [J]. Medical Education Research and Experimentation, 2021, 29(1): 29-31.
  - [5] Wei Shaoyuan, Tong Shaocheng, Lu Yi. Exploration and Practice of the Reform of Elective Courses in Higher Institutions [J]. Heilongjiang Education (Higher Education Research and Evaluation) 2012(2): 52-53.
- Project: The Second Batch of Curriculum Assessment Reform Pilot Project of Sanya University - Packaging Design Project Number: SYJGKH2023013

# On the Differences in Subjective Expressions in Contemporary Freehand Landscape Oil Painting

Lele Chu, Lingxi Zhou

ZheJiang Normal University, Jinhua 321000, China.

---

**Abstract:** Nowadays, freehand landscape oil painting has become the most important painting in China. Artists create unique artistic works by subjectively experiencing the scenery and objectively depicting it. This article focuses on the differences in subjective expression in landscape oil painting from life, providing more creative possibilities for freehand landscape oil painting.

**Keywords:** Freehand oil painting; Landscape painting; Subjective expression

---

## 1. Introduction

Oil painting and landscape painting have a long history, and since Impressionism, painters have been exploring innovative expressions in oil painting creation through landscape painting. At the beginning of the 20th century, China began to learn Western oil painting. Western oil painting was localized in China and became the most important painting in China today. Freehand landscape oil painting is an important product in achieving the localization of oil painting. Mr. Liu Gongliu strongly advocates for freehand brushwork oil painting, and he explicitly states that “freehand brushwork oil painting is a form of creation.” Therefore, it is particularly important for Chinese freehand brushwork oil painting to improve the subjective expression of freehand brushwork landscape oil painting artists and embark on a new path of freehand brushwork landscape oil painting.

The landscape painting performed by mature oil painters is also a process of painting creation, with both freehand brushwork and vivid imagery. Oil painting and landscape sketching are the main ways for contemporary landscape oil painters to complete their works, as well as an important method of oil painting practice. Through sketching, it can enhance the painter’s intuition and sensibility, change the way the painter observes the world, exercise the painter’s perception and expression in terms of shape and color expression, and improve the painter’s freedom to express their own emotions.

## 2. Differences in subjective expression in freehand brushwork oil painting

Freehand landscape oil painting from life is a complex creative process, and different painters may use different methods to create differences in the subjectivity of the painting. In addition to the different tools used by painters in selecting materials, the selection of landscape materials by painters in the process of sketching can also cause differences. The source and object of sketching play a fundamental role in the final result of the painting.

In addition, the painter’s handling of the objective and subjective relationship of the painting can also lead to differences in subjective expression. After obtaining observation results from objective objects, the painter often first thinks about the image of the painting in his brain, completing the transformation from objective object images to image images. This process, through intuition and perception, combined with his own experience, produces different choices, segmentation, composition, and arrangement and combination of points, lines, and planes for objective scenery. The tendency of color and the expression of tone, including the painter’s own emotions, can also affect the painter’s perception of observing scenery. The painter’s painting techniques are the product of experience formed through long-term painting and sketching practice. On the one hand, this is the summary of the painter’s experience in the long-term painting process, which has unique characteristics and artistic value; On the other hand, these experiences will constrain the painter’s expression, posing risks to conceptualization and patterning in the sketching process. So, in terms of painting techniques, in the process of oil painting landscape painting, it is the painter’s choice of expression methods, and at the same time, patient observation and rich emotional experience are also needed to break the constraints of traditional techniques. This will make the process of oil painting landscape painting no longer a simple repetition of techniques, and make art have the vitality of expression.

### **3. The painter's subjective changes to objective objects during the process of sketching**

One is the arrangement of the screen composition. In the process of sketching, painters usually subjectively discard or add some scenery during the composition of the picture, and their subjective consciousness plays a major role in this process. The composition of sketching works depends on the objective existence of the sketching objects, and is also the source of subjective choices and transformations by painters. In terms of composition, painters need to choose elements from objective scenery for picture composition. Under the influence of the objective existence of the object and the painter's subjective emotions, composition presents objectivity and subjectivity in sketching, which is the beginning of the painter's innovation in painting. Compared to the realistic existence of objective objects, the composition of sketching images should reflect both painting and artistry. The composition of painting works will be arranged around elements such as emptiness, harmony, fullness, and contrast that need to be conveyed by the relationship between the images. These emotional expressions rely on the subjective emotions of objective objects and painters, and are specific, connected to objective objects, and different from the real existence. The composition arrangement has strong subjectivity and freedom. The composition in oil painting landscape painting needs to break the constraints of objective objects and rely on the painter's subjective emotional choices to freely combine the composition of the picture. This combination can not only extract typical objective objects from the perspective of the picture, but also highlight the painter's subjective choices and artistic concepts. The composition of a painting is the fundamental carrier for conveying the artistic quality of the work. Oil painting and landscape sketching is not only a process of painting practice, but also a process of completing and generating oil paintings. Therefore, it is inevitable for painters to make subjective adjustments to the composition of their works during sketching.

The second is to change the color of the screen. Every color block, stroke, and tone on the canvas emanates from the depths of the painter's soul. Every excellent landscape oil painting sketch contains the inspiration and spiritual connotation of the painter, as well as a unique understanding of color. It can be said that it is the subjective color of the painter's subjective consciousness that makes our landscape oil paintings more thoughtful and interesting. The subjective color application in oil painting landscape painting is influenced by several factors. The visual experience formed by painters through observing objective objects, that is, the color relationship directly obtained in the depicted objects, varies from person to person, and different painters have different perceptions of the same object's color; Painters have different emotional states when sketching, and the use of colors in painting directly reflects emotions, which is the manifestation of the painter's inner thoughts; The different habits of painters in using colors are obvious and formed over a long period of time. This inertia, like the composition inertia in painting, is undeniable. The grayscale, amount, unity, and comparison of colors are all a process of habit development, which greatly affects the painter's choice of color in oil painting landscape sketches.

The third is the adjustment of the image shape: in order to make the image more harmonious or interesting and formal, painters often subjectively and consciously change a certain shape. Subjective adjustments are also being made to the appearance of objective objects, making the appearance and structure of the scenery in the picture more in line with the needs of the picture. The image of scenery in painting is specific, and it needs to meet the overall needs and present the appearance characteristics of the scenery in the picture. Therefore, every specific appearance in the oil painting landscape sketch picture needs to be studied and adjusted. The fourth is to control the overall structure and rhythm of the picture: the unity of rhythm beauty and rhyme beauty achieves form beauty, and form beauty is the internal and external expression of the landscape oil painting work. The sense of form in a painting is formed by the artist's artistic processing of objective scenery. The mastery of form directly affects the infectivity of a painting. Painters can create infectious works by subjectively grasping the artistic conception of the picture.

Ultimately, through multiple subjective choices from the above aspects, the painter achieves subjective changes to objective objects in the process of sketching, achieving artistic differences in the sketching images.

### **4. Conclusion**

The different subjective processing methods used in contemporary freehand oil painting landscape painting practice present different visual results, which can reflect the richness and diversity of artistic expression. The diversity of subjective choices provides a vast space for the subjective expression of oil painting landscape sketching. Painters need to constantly explore, move with emotion, and strive to showcase

the artistic value of contemporary oil painting landscape sketching works, adhere to integrity and innovation, and achieve the development of oil painting art and individual painters.

## References

- [1] Susan Langer Emotions and Forms [M] Beijing: China Social Science Press, 1986
- [2] Zhang Wenhao Observation and Expression Methods in Oil Painting Landscape Sketching [J] Art 100, 2010 (06).
- [3] Cao Ruizhen. The use of freehand language in contemporary oil painting landscape sketches [J]. Dagan, 2022 (04): 152-154.
- [4] Zheng Jiangle. Subjective Expression in Oil Painting and Landscape Sketching [J]. Youth Years, 2022 (02): 49-51.
- [5] Li Hongfeng. The Application of Freehand Language in Contemporary Oil Painting Landscape Sketching [J]. Artist, 2021 (04): 36.
- [6] Zhou Zhiyu Color Sketching: A Series of Featured Courses in Famous Chinese Higher Education Institutions [J] Hubei Fine Arts, 2008 (9).

# Reform of the rural land system and the exploration of the road of socialism with Chinese characteristics

Lan Zhang

School of Marxism, Anhui University of Finance and Economics, Bengbu 233030, China.

---

**Abstract:** looking back at the history of the founding of new China, new China's rural land system is not fixed, but with the continuous development of history, the party and the government in practice, for different periods of marxist basic principle, seeking truth from facts, have the courage to face mistakes, adhere to the road exploration spirit constantly improve China's rural land system. The process of China's rural land system reform is a from certain to negative, from negative to certain the dialectical evolution process, from farmers' land ownership, to collective ownership, to the household contract responsibility system, to today's "separation division", China's rural land policy is in the process of the movement of the contradiction constantly developing, constantly perfecting the land system in our country.

**Keywords:** Land reform; Dialectics; Historical materialism; Road exploration

---

With the continuous development of history, different land policies were made according to the social conditions at that time. The Party and the government have been constantly exploring in practice, applying the basic principles of Marxism in different periods, seeking truth from facts, daring to face mistakes, always adhering to the continuous improvement of China's rural land system through evolution, exploration, improvement and promotion, and adhering to the spirit of road exploration.

## 1. The evolution process of the rural land system after the founding of new China

### 1.1 The rural land system before the reform and opening up

In the founding of the People's Republic of China in 1949, the innovation of various systems was followed successively, including the reform of the rural land system. In the early days of the founding of new China, the rural land system experienced historic changes in a relatively short period of time.

#### 1.1.1 *Farmers-owned, individual management*

After the founding of the People's Republic of China, China is in the transition stage from new democracy to socialism. Land reform has not yet been implemented in the vast liberated areas, and most of the rural land is still owned by the feudal landlords<sup>[3]</sup>. In order to further consolidate the achievements of the new democratic revolution, maintain the stability of the new people's political power, and meet the needs of economic recovery and development after the founding of the People's Republic of China, China promulgated the Land Reform Law in 1950, abolished the past feudal ownership of land, and decided to carry out land reform in the liberated areas and distribute land to farmers. The promotion of this system marks the completion of the first land reform system in new China and the development of the individual ownership of farmers.

#### 1.1.2 *Farmer ownership, collective management*

The aforementioned land reform gave farmers only the ownership of the old landlords, and did not change the private ownership of the land. The land could still be bought and sold freely<sup>[3]</sup>. In view of this problem, the Party began to explore agricultural cooperation in rural areas in 1953, mainly to encourage the development of mutual assistance groups in agricultural production. At this stage, land ownership is still farmers' private ownership, only helping each other in some production stages. Primary agricultural cooperatives are a collective economic organization, in which members' land, livestock, farm tools and other means of production are shared, which gradually become common property, and cooperative members work together to share the fruits of their labor. Although the private nature of the farmers' land has not changed, the ownership and right to use of the land have been separated, and the ownership still belongs to the farmers, but it is managed collectively.

### *1.1.3 Collective ownership, collective management*

In 1956, the Party proposed to further develop primary cooperatives, transfer all land assets related to production to the collective, and then the collective distribution, and the members of the production cooperatives received corresponding remuneration according to their own labor. But at this stage, there are still a small number of members who can disperse the land, but farmers can only manage the land. It was not until the end of 1956 that the collective ownership of rural land was basically formed. In 1958, Comrade MAO Zedong believed that small cooperatives were not conducive to the development of production, so he decided to cancel the cooperatives and transform and upgrade them into people's communes. And the people's communes should be continuously expanded. Although most of the land at this time was still collective, the members' private land could be used for free. In the later period, the members' private lands were all recovered and returned to the state. At this time, the farmers' private ownership of the land really ended.

## **1.2 The rural land system after the reform and opening up**

In 1978, the reform and opening up entered thousands of households, and at the same time, the land policy of new China has undergone earth-shaking changes. According to the power of land, the reform process of the land system after the reform and opening up is divided into two parts: the land system of "separation of two rights" and the land system of "separation of three rights".

### *1.2.1 Land system of "separation of two rights": 1978-2012*

In 1978 is a historical turning point, is also a new journey, this year of reform and opening up, while the land policy in the second major reform, Anhui fengyang xiaogang village of household contract responsibility system is actually farmers in the name of the contract operating the land, but the ownership of the land still belongs to the state, strictly control land circulation<sup>[4]</sup>. In order to promote this excellent production cooperation mode to the whole country, the country has issued relevant documents to vigorously support this cooperation mode every year for the next five years of 1982. The land reform system for the first time to distinguish the land ownership and use right in China, in order to improve the farmers land use right, countries issued in 1984 the notice about 1984 rural work to increase its right to 15 years, in 1993,15 years land contract period, the central documents and instructions land contract period to 30 years, the household contract responsibility system to continue. Land contract management realizes the separation of "two rights" of agricultural land. The collective ownership of land and farmers 'contracted farming rights have changed from the single ownership of all land rights to the dual ownership<sup>[3]</sup> of collective land and farmers' contracted farming rights.

### *1.2.2 Land system of "separation of three rights": from 2012 to now*

After the 18th National Congress of the Communist Party of China, socialism with Chinese characteristics has entered a new era of development. General Secretary Xi Jinping stressed that China's rural reform should stay true to its original aspiration. In the trend of the new era, the leading direction of rural reform is still to give priority to the relationship between farmers and land. In 2014, on the basis of the land ownership belongs to the collective, "realize the separation of ownership, contracting rights and management rights, and guide the orderly transfer of land management rights". In 2016, the policy of "separation of the three rights" was clarified, and the "separation of the three rights" mode of land ownership under collective ownership, farmers enjoying the right to contract, and the marketization of management rights was realized. Thus, a new round of rural land system reform in China has officially begun.

## **2. Theoretical basis of China's rural land reform**

In the 70 years of land reform since the founding of the People's Republic of China, Chinese Communists have always developed the rural land system with Chinese characteristics in accordance with Marxist historical materialism and the basic laws of social development. The following paper analyzes the theoretical basis for the development of China's rural land system since the founding of the People's Republic of China from the perspectives of Marxist dialectics and Marxist historical materialism.

### **2.1 The perspective of Marxist dialectics**

From the beginning of the founding of new China to the present, the process of China's rural land system reform is a dialectical evolution process from affirmation to negation, from negation to affirmation. First, abolish the private ownership of the feudal landlords and return

the ownership of the land to the peasants; In the three reconstruction periods, the land ownership was transferred to the collective, which was a positive stage. However, in order to expand the scale of production, to establish the people's commune system and then improve the productive forces, at this time, the relations of production will no longer adapt to the productive forces and violate the law, leading to the farmers generally in poverty, which is a negative stage of the land ownership of farmers. The emergence of the household contract responsibility system in 1978, arouse the enthusiasm of most farmers, agricultural productivity, this is the negation of the people's commune system, including late land property rights experienced "two rights separation" to "separation division", land property right is seemingly to restore the farmers land ownership at the founding of new China, is not restored farmers land ownership, but on the basis of the land collective ownership of expanding the management rights. China's agricultural land system has gone through two "dialectical negation", to some extent, denied the first two stages of the land system, so that the development of China's land system is more perfect.

## **2.2 The perspective of Marxist historical materialism**

Marx's historical materialism was acquired on the basis of the study of the general process of human historical and realistic movement. The process of human history is no longer interpreted as the development process of ideas, but completely based on the objective process of real social history.

### *2.2.1 The basic social contradiction is the fundamental motivation of the land system reform*

Marx and Engels pointed out that when the productive forces and the relations of production conflict, the society needs to undergo a revolution. As an objective factor of the historical process, all the changes of the land possession system express the movement law of the basic social contradictions. The change of the land use right system is not determined by people, but by objective laws and specific social and historical conditions. Under the guidance of the basic social contradictions, the different stages of the evolution of the land system are related to the general change process of the land system, which is the internal law of the land system.

### *2.2.2 Productivity and production relations interact*

According to the Marxist historical materialism, the productive forces are the material force that determines the development of social conditions, and are "the basis of human social life and all history". The relationship of production is the economic relationship formed in the process of material production that is not transferred by the will of people. It reflects the relationship between people. In addition, the ownership of the means of production also determines the social nature<sup>[4]</sup>. The people here are not isolated, atomic people, but people in society. The old system will not perish as long as it can promote the development of the social productive forces; the new system will not be particularly mature until it develops the productive forces vigorously. Land is the most basic material production in the process of rural historical development, the development of rural productivity determines its ownership relations, on the one hand, the agricultural productivity level determines the allocation of rural social resources, on the other hand, this decision reflected in the special material production of workers and the progress and development of agricultural production tools. With the continuous development of productive forces, the corresponding rural production relations also need to be adjusted accordingly, otherwise it will hinder or even restrict the development of productive forces. In the early days of the founding of New China, the level of industrialization of China was low and the productivity severely restricted the development of productivity, and the ownership of land returned the land to the farmers, stimulating the enthusiasm of farmers. Under the premise that the production relations of China were the socialist interest, after the completion of the three reforms, in this problem, China adopted the form of the people's commune of land, without the enthusiasm of farmers in production, the production development entered the bottleneck period. It is because of the one-sided emphasis on collective ownership, the relations of production greatly advanced the level of productive forces at that time, divorced from reality and violated the basic principle that the relations of production must adapt to the development of productive forces.

## **3. Explore the road spirit of the Communist Party of China from the land reform**

Hegel believes that anything is in the dialectical development of "positive", in the process of Marx's words, "is to set yourself, since the opposite, self phase synthesis, is the point, thesis, topic, or its self affirmation, self-denial negative self denial" such a negative movement process. The reform process of China's agrarian revolution presents the spirit of such a "positive and negative integration" road exploration.



### 3.1 The “main topic” in the land reform

The so-called “main topic” is the law of the new China since the founding of the law, a stage of self. In the early days of the founding of new China to the completion of the three major reforms, the rural land system in our country changed from the private ownership of the feudal landlord class to the peasant land ownership and then to the collective ownership of peasant land, but there are still some farmers who can have private land. Compared with the early days of the founding of new China, our farmers realized the land as the masters, willing to production, so the agricultural productivity is improved, this is the affirmation of land policy reform in our country, observe the fundamental rules of social development, namely match production relations and productivity, superstructure must change according to the economic base change. In addition, the people have always been the most powerful weapon of our Party. The promotion of China’s rural land system is all for the well-being of the people, so that the broad masses of the people will so support and support China’s rural land policy, and China’s rural land system will be constantly improved. Therefore, following the basic laws of social development and adhering to the people-centered are the “business points” in the process of China’s land reform.

### 3.2 The “counterquestion” in land reform

Three completed after the people’s commune system is not like marxist theory of public land, the enthusiasm of the people, agricultural productivity has not improved, this is not a marxist theory of land public wrong, but because the production relations greatly ahead of the productivity of the conditions, influenced by “left”, the national must establish people’s commune system, the farmers land ownership completely killed, farmers make the material means of production owned by the collective, one-sided emphasis on the development of collective ownership economy, cancel the individual ownership economy. This not only divorced from the actual situation of the productive forces at that time, but also went against the will of farmers, causing the strong dissatisfaction of the majority of farmers, reducing the enthusiasm of farmers for production, and making agriculture and rural economy in a state of slow development or even stagnation for a long time. For these “countertopic” we should resolutely abandon, with “the blade inward, scraping the fearless spirit of the poison”.

### 3.3 “Cooperation topic” in land reform

In 1978, the communist party of China in following the basic law of social development and the people as the center, on the basis of to admit mistakes, correct mistakes, promote household contract responsibility system, completely separate the land ownership and the contracted management, makes the original land property rights owned by the collective single property rights system, into the ownership and the contracted management of land respectively belongs to the collective and farmers two subjects of the dual property rights system. This greatly aroused the enthusiasm of farmers, made farmers become independent business units, obtained the support of their own labor, promoted the development of rural economy, and solved the problems brought by the previous people’s commune system. Later along with the development of urbanization and industrialization, the rural population gradually presents a “hollowing out”, in the face of a large number of land management, the state and implement the contracted management of land into contract right and management right, let management orderly circulation, countries have land ownership, farmers have contract right, and the management marketization circulation such a “separation” mode, this is in the “two power division” on the basis of innovation and upgrade, on the basis of the marxist basic theory, in the road to explore constantly theoretical innovation and practice innovation.

We are to have the courage to explore road, in accordance with the basic law of social development, adhere to the people as the center, adhere to seeking truth from facts, actively explore to meet the productivity development of rural land system reform and innovation, the farmers’ enthusiasm and creativity, found and adhere to the “topic”, dig out and abandon the “thesis”, completes the rural land policy this “topic”, promote the continuous improvement of rural land policy.

## References

- [1] Of Chinese President Xi Jinping. Learn history, history, credit, history, history [J]. Knowledge, 2021 (08): 4-9.
- [2] The China Social Science Network. Research on the reform and innovation of Rural Land System in China in the New Era [EB /

OL]. (2019-08-27)[2021-12-27].

[3] Wang Qingrong. A brief analysis of the changes of new China's land policy —— from the perspective of Marxist land theory [J]. Nanguo Today (Theoretical Innovation edition), 2009 (05): 208-209.

[4] Cao Yang. Research on the practice of rural land reform in China [D]. Beijing Jiaotong University, 2019.

[5] Das Kapital, Volume 1 [M]. people's publishing house.

[6] Tang Hui. The change of rural land system of the Communist Party of China: motivation, logic and enlightenment —— Based on the perspective of basic social contradictions [J]. Research on Party and Government, 2021, (05): 34-43.

[7] The Complete Works of Mann Volume 13 [M]. people's publishing house.

About the author:LAN Zhang (1998-), female, Han Nationality, born in Anqing, Anhui province, School of Marxism, Anhui University of Finance and Economics, postgraduate, research direction of Marxism.

Fund Project: 2021 Graduate Scientific Research and Innovation Fund Project of Anhui University of Finance and Economics “Research on the Effective Path of Left-behind Women in Promoting Rural Cultural Construction” (ACYC2021525)

# The role of differential equations in environmental science modeling

Sen Zhao, Zhuo Qi, Jing Lu

Liaoning Institute of Science and Engineering, Jinzhou 12100, China.

---

**Abstract:** Differential equations play a key role in environmental science, providing mathematical tools for understanding environmental processes and predicting change. This study explores in depth the application of differential equations to environmental models, especially in pollutant dispersion, ecosystem dynamics, and climate change prediction. This paper expounds the theoretical basis, modeling method and solving process of differential equation in detail, highlighting its role in revealing the complexity of environmental system. At the same time, the importance of model verification and uncertainty analysis is emphasized. This paper also points out the future development potential of differential equations in interdisciplinary integration and advanced computation, which provides research direction and improvement path for the field of environmental science.

**Keywords:** Environmental science; Differential equation; Model construction

---

## 1. Introduction

Environmental science is of critical importance in the context of global environmental issues relating to ecosystem conservation, sustainable development strategies and human well-being<sup>[1]</sup>. At the heart of the discipline is an understanding of the impact of natural processes and human activities on the environment, covering areas such as climate change, biodiversity, water resources and pollution control. In this field, differential equations play a key role, enabling scientists to describe the complex dynamics of environmental systems through mathematical models [2-3]. These models not only apply to fundamental processes, but also extend to more complex systems such as climate change and ecological dynamics. The application of differential equations enables scientists to analyze environmental problems in depth and propose effective solutions [4-5]. Therefore, differential equations serve as an important tool in environmental science modeling to help scientists better understand environmental systems and provide scientific basis for solving environmental challenges.

## 2. Fundamentals of differential equations

Differential equations, as mathematical equations containing unknown functions and their derivatives, are a key tool for understanding the rate at which a function changes over time or in space<sup>[6]</sup>. The general form of the differential equation can be expressed as:

$$F(x, y, y', y'', \dots, y^{(n)}) = 0$$

Where,  $y = y(x)$  is an unknown function,  $y', y'', \dots, y^{(n)}$  is the first, second, and  $n$  derivatives of this function, respectively, and  $F$  is a given function.

Differential equations are divided into two main categories based on the number of variables of the unknown function: ordinary differential equations (ODEs) and partial differential equations (PDEs). Ordinary differential equations describe functions of one variable, which can be expressed by first-order linear equations as:

$$\frac{dy}{dx} + P(x)y = Q(x)$$

Where,  $P(x)$  and  $Q(x)$  are known functions.

Partial differential equations involve multivariable functions, such as the two-dimensional heat conduction equation can be expressed as:

$$\frac{\partial u}{\partial t} = \alpha \left( \frac{\partial^2 u}{\partial x^2} + \frac{\partial^2 u}{\partial y^2} \right)$$

Where,  $u = u(x, y, t)$  is the temperature distribution function, and  $\alpha$  is the heat conduction coefficient.

Differential equations play a central role in many disciplines. In physics, Newton's second law  $F = m \frac{d^2x}{dt^2}$  is expressed as a differential equation, where  $F$  is the force,  $m$  is the mass, and  $x$  is the position.

Population dynamics in biology are described by the Lotka-Volterra equations, which describe predator-prey interactions.

In economics, the Solow model is used to simulate capital accumulation and economic growth, and can also be expressed by differential equations.

These examples highlight the importance of differential equations in scientific research and technological development, especially in understanding and simulating the dynamic behavior of complex systems.

### 3. Application examples in environmental science

Differential equations are widely used in environmental science to understand and predict the behavior of complex systems. For example, the degradation of pollutants in water can be described by the first-order linear equation  $\frac{dC}{dt} = -kC$ , showing an exponential decline in concentration over time.

Where,  $C$  represents the pollutant concentration,  $k$  is the degradation rate constant.

In ecology, Logisstick Model  $\frac{dP}{dt} = rP \left(1 - \frac{P}{K}\right)$  describes population growth as limited by environmental carrying capacity.

Here,  $P$  is the population size,  $r$  is the inherent growth rate, and  $K$  is the environmental carrying capacity. As the growth rate approaches the growth rate decreases.

Atmospheric pollution diffusion is modeled by convection-diffusion equation  $\frac{\partial C}{\partial t} + u \frac{\partial C}{\partial x} = D \frac{\partial^2 C}{\partial x^2}$ .

Here,  $C$  is pollutant concentration,  $u$  is wind speed,  $D$  is diffusion coefficient,  $x$  and  $t$  are spatial location and time, respectively.

Climate change represents energy balance through equation  $C \frac{dT}{dt} = S(1 - \alpha) - OLR$ .

Where,  $T$  is the Earth's surface temperature,  $C$  is the heat capacity,  $S$  is solar radiation,  $\alpha$  is albedo, and  $OLR$  is radiation to the foreign wave.

These models not only reveal the mechanism of environmental phenomena, but also provide scientific basis for decision-making.

### 4. Modeling of differential equations in environmental science

In environmental science, differential equation modeling follows clear steps:

First, the problem is defined and the relevant theory and data are collected, and then the hypothesis is established. For example, suppose that pollutants are evenly distributed in a body of water. Second, formulaic models of differential equations that describe, for example, changes in pollutant concentrations over time and space are used to solve these equations with the aim of obtaining analytical or numerical solutions. Fourth, after verification and adjustment with experimental data, the model is used for forecasting and actual environmental management decisions.

For example, consider the diffusion and degradation of pollutants, which can be described using the first-order differential equation

$$\frac{dC}{dt} = -kC.$$

Where,  $C$  is the concentration of the pollutant,  $k$  is a normal number representing the degradation rate.

By separating and integrating the variables,  $C = C_0 e^{-kt}$  is obtained, showing that the concentration decreases exponentially with time.

Where,  $C_0$  is the initial pollutant concentration.

Although simplified, this model provides a basis for practical applications and can be extended as needed, such as to account for spatial distribution and changes in environmental conditions.

## 5. Solve differential equations and verify and analyze models

In environmental science modeling, solving differential equations is the core link, which involves solving expressions of unknown functions. Analytical methods are used to obtain exact solutions of differential equations and are suitable for simple linear equations. For example, the first order linear differential equation

$$\frac{dy}{dx} + P(x)y = Q(x).$$

Where  $P(x)$  and  $Q(x)$  are known functions.

Solving such an equation involves calculating the integral factor  $\mu(x) = e^{\int P(x)dx}$ , then multiplying both sides of the equation by the integral factor and integrating to get the solution.

Numerical methods are suitable for more complex equations, such as nonlinear or partial differential equations. Euler's method is a basic numerical solution for the initial value problem  $\frac{dy}{dx} = f(x, y)$ ,  $y(x_0) = y_0$ . By selecting a small step size  $h$  and iteratively calculating  $y_{n+1} = y_n + hf(x_n, y_n)$ , the solution of the equation can be approximated.

These methods are key techniques for solving differential equations in environmental science modeling. Through these techniques, complex environmental systems can be mathematically described and analyzed to better understand and predict environmental changes.

## 6. Future trends and challenges

The application of differential equations in environmental science is facing challenges and showing obvious development trend. With the deepening of multidisciplinary integration, such as the combination of computational science, data science and social science, differential equation models are becoming more complex and applicable, and can reflect the dynamics of environmental systems more comprehensively. In addition, with advances in computing power and algorithms, the solution of complex differential equations such as high-dimensional partial differential equations is becoming feasible, providing more accurate simulations of environmental processes. At the same time, the convergence of machine learning and artificial intelligence is also improving the predictive efficiency of models and their ability to handle large-scale data.

However, the complexity and nonlinear nature of environmental systems make modeling challenging, especially in terms of parameter uncertainty and data quality. For example, climate change models need to take into account the interactions of multiple systems. The proposed solutions include developing more efficient numerical methods and calculation tools, using data fusion technology to improve the estimation of model parameters, and using statistical methods to analyze model sensitivity and quantify uncertainty.

In conclusion, the application of differential equations in environmental science is promising, and they help to describe and predict environmental processes more accurately. In the face of current challenges, interdisciplinary cooperation, technological innovation and methodological development are key and are expected to overcome these difficulties effectively.

## 7. Summary

Differential equations play a key role in environmental science, providing powerful tools for understanding and predicting environmental systems. Through mathematical modeling, differential equations help scientists accurately describe and analyze complex environmental problems, and provide scientific basis for environmental management decisions.

Differential equations capture dynamic and nonlinear relationships in environmental systems such as pollutant dispersal, population dynamics, and climate change. They not only predict environmental variables, but also support policy making.

Future research needs to integrate statistics, machine learning and other technologies to improve the accuracy of the model. Collaborate across disciplines to build more comprehensive environmental models. Challenges including complex system modeling, parametric uncertainty, and data quality can be addressed through enhanced computational methods, data fusion, and model sensitivity analysis.

Differential equations are crucial in solving environmental problems, and improved models help to understand the Earth system and promote environmental protection and sustainable development.

## References

- [1] Tsokos, C. P., & Xu, Y. (2009). Modeling carbon dioxide emissions with a system of differential equations. *Nonlinear Analysis-Theory Methods & Applications*, 71(12), E1182-E1197.
- [2] Lu, Z. L., Zhenwei, & Wang, H. L. (2016). The application of regression analysis and differential equation models in the prediction of indoor PM2.5 concentration. *Journal of Residuals Science & Technology*, 13(1), 325-328.
- [3] Tiwari, J. L., & Hobbie, J. E. (1976). Random differential equations as models of ecosystems .2. Initial condition and parameter specifications in terms of maximum entropy distributions. *Mathematical Biosciences*, 31(1-2), 37-53.
- [4] Liu, Y. L., Chen, C., Alotaibi, R., & Shorman, S. M. (2022). Study on audio-visual family restoration of children with mental disorders based on the mathematical model of fuzzy comprehensive evaluation of differential equation. *Applied Mathematics and Nonlinear Sciences*, 7(2), 307-314.
- [5] Kafle, R. C., Pokhrel, K. P., Khanal, N., & Tsokos, C. P. (2019). Differential equation model of carbon dioxide emission using functional linear regression. *Journal of Applied Statistics*, 46(7), 1246-1259.
- [6] Cai, W. G., & Pan, J. F. (2017). Stochastic differential equation models for the price of European CO2 emissions allowances. *Sustainability*, 9(2), 207.

### Author Bio:

Zhao Sen (1994.01-) Male, Han, Xinmin, Liaoning, Master, Assistant Professor, Research Interests: Isolators and Accumulator Systems

QI Zhuo (1985.04-), Female, Man, Jinzhou, Liaoning, China, Master, Lecturer, research interests: ant colony algorithms.

Lu Jing (1997.04- ), Female, Han, Linghai, Liaoning, M.S., Assistant Professor, research interests: rings and modular categories.

# Information Technology Impact on Corporate Governance: A Literature Review

Jiajia Deng<sup>1</sup>, Xinliang Ma<sup>2\*</sup>

1.Changji University, Changji 831100, China.

2.University of Stirling, UCASS, Beijing 100102, China.

---

**Abstract:** Corporate governance refers to the system of rules, practices, and processes by which companies are directed and controlled. Information technology (IT) has become an integral part of modern business operations, and its impact on corporate governance has been a subject of interest for researchers and practitioners alike. This literature review aims to provide an overview of the existing research on the impact of IT on corporate governance.

**Keywords:** Corporate governance; IT; Literature review

---

## 1. Introduction

Corporate governance has become an increasingly important topic in recent years, primarily due to the number of corporate scandals that have led to a decline in shareholder equity, a reduction in investor interest and major bank failures in some cases. (Bagais & Aljaaidi, 2020). In recent years it can be found that information technology impacts on companies is researched and analysed by researchers practically and frequently in kinds of aspects. Cloud computing, mobile Internet and some other innovated IT are greatly affecting the production, operation, and business model of enterprises from various aspects. Along with the development and maturity for Internet technology, applications for new IT will further enhance information sharing within enterprises, alleviate the problem of information island, and provide the possibility for the subversive reform of corporate governance. Therefore, this literature review is mainly to sort out and analyze the previous problems of corporate governance from the perspective of information technology application, explore the limitations and gaps of previous research, and analyze the significance and impact of information technology application on corporate governance.

## 2. Literature Reviews

### 2.1 Corporate Governance

Corporate governance is a set of mechanisms, procedures, systems and relationships that different parties implement to control and manage a company or enterprises (Levillain & Segrestin, 2019). In business environment corporate governance means managing company rules, practices and process systems. By this view, the model of corporate governance for a particular company is the distribution of rights and obligations among all participants in the organization. Corporate governance makes sure that stakeholders in the company or enterprise follow suitable and transparent management processes and ensures that the interests of all stakeholders, including employees, loaners, shareholders, suppliers, communities, etc., are secured. Corporate governance refers to how to ensure the returns of the investment from the investors shall be fair. A good corporate governance system will ensure a clear boundary between the shareholders and management levels. The corporate governance is not the daily management totally. It can be a system that includes the company rules, procedures, practices that the ways of controlling and managing the company for different levels of organization (Situ, Tilt, & Seet, 2020).

### 2.2 IT Impacts on Corporate Governance

The use of IT in a company is divided into many stages, and the use of IT often leads to the change of enterprise organization and the reengineering of business processes. This paper analyzes the application of information technology in a company, analyzes the use of IT in a corporation, and analyses the use of IT in a corporation. For example, in accounting business, throughout the development of each stage, accounting computerization is the change of accounting from 0 to 1, but in essence, only the computer acts as the tool of traditional accounting, only the change of accounting information processing means (Xue, 1997); The subsequent ERP system is the advance of accounting from 1

to n, which enables enterprises to realize a wider range of business and financial connections (Zhang et al., 2005). However, under the ERP system, finance is still a decentralized management mode in the organization and only bears the role of record (Sun, 2002). The emerging management mode of financial sharing service center overcomes the barriers of time and space, aggregates the originally closed and scattered finance into one point, and realizes financial information sharing through process and information system reengineering (Schulman et al., 1999).

Gradually, with the development of information technology, the IT function provides the possibility to realize the strategic change thought of the organization (McDonald and Teschler, 2007; Robinson et al., 2005). Gradually, some domestic and foreign enterprises began to try to establish their own information systems, and scholars also began to explore the influence of information systems in the actual operation in the company's production and operation, organisation and management. The study found that public organizations such as national governments and more than 70% of the international Fortune 500 companies have established information systems. Information systems integrate resources across multiple levels of an organization to reduce repeated information processing and increase the sharing methods of data, knowledge, information, and experiences within the organization (Wang et al., 2007), thereby enhancing organizational value by saving costs and enhancing service quality (Richter and Bruehl, 2017). Specifically, the implementation of information systems in enterprises includes the establishment of reimbursement system, bill system, financial system, bank-enterprise direct connection system, performance management system, credit investigation system, employee self-service system, logistics system and internal control system (Yao et al., 2012), which then provides professional and standardized management services for enterprises. But so far, the research on information system is not enough, and the existing research can be roughly divided into three aspects: determinants of the establishment of information system, the operation process and operation results of information system. First of all, scholars often use qualitative research methods to explore the success factors of information system establishment (Richter and Bruhl, 2017). For example, through case studies of multinational companies such as Procter & Gamble (Howard and Mari, 2010) and Ericsson (Lindvall and Iveroth, 2011), it is concluded that the key factors for successful business process reengineering include enterprise environment, organizational structure, and information technology (Mansar and Reijers, 2007). Secondly, in terms of the operation process of the information system, existing studies have shown that compared with the traditional management mode, the information system mode is more autonomous, and because it is an independent operator, it will take clear responsibility for the behavioral results of the center (Schulz et al., 2009). Finally, in terms of the operational effect of the information system, Ren et al. (2008) found that the sharing center may have the risk of failure in the implementation process, and the cultural differences and strategic objectives of the organization should be paid more attention to as establishing information systems (Frey et al., 2008).

### **2.3 Informatization and Corporate Governance**

McAfee and Brynjolfsson (2012) pointed out that enterprise informatization can effectively improve the accuracy and effectiveness of enterprise capital allocation decisions. Informatization can help enterprises optimize resource allocation, improve production efficiency, strengthen the self-supervision behavior of the management, adjust the possible irrational decision-making in the decision-making process, avoid the behavior of manipulation, and further improve the level of corporate governance. The analysis of Grove and Clouse et al (2018) found that the application of IT will improve the profitability for corporations, provide more valuable judgment, and help to discover new business opportunities. If the management wants to increase the level of corporate governance through IT, it needs to pay attention to business performance and KPI to gain competitive advantage, which in turn requires higher requirements for senior executives and improves corporate governance. Qi and Xiao (2020) studied the reform of enterprise management in the information age and found that enterprise informatization can promote the transformation of enterprise goals and the innovation of governance structure, thus changing the internal management mode of enterprises. Qi and Cao et al. (2020) found through empirical research on A-share listed companies that enterprises with high informatization degree have higher governance level. Information-based enterprises effectively improve the level of corporate governance by reducing information asymmetry and the irrational degree of managers' decision-making, which further promotes the development of enterprise informatization and improves the efficiency of corporate governance. Liu Zheng and Yao Yuxiu et al. (2020) used micro-enterprise information to test the affecting of enterprise informatization on organizational empowerment and its core mechanism empirically. The study



finds that, driven by informatization, the cost of information management is reduced, and the agency cost is also reduced, thus promoting decentralization reform. Therefore, corporations shall pay attention to the distribution law and transfer process of internal special knowledge, improve the adaptability of the organization, and cope with the impact of informatization, so as to ensure that the transmission of internal and external information will not be distorted or lost, and thus improve the corporate governance ability.

### 3. Discussion and Conclusion

In the above reviews, it is summarised that the definition and research analysis of kinds of aspects of corporate governance theory, influencing factors of corporate governance, information technology and corporate governance in the existing literature. This not only provides a solid foundation for future research work, but also provides a basis for detailed analysis of related issues in these aspects in the future.

In the research on the influencing factors of corporate governance, The analysis logic of the existing literature is to try to find that some internal factors (such as board mechanism, board of supervisors mechanism, equity structure, executive compensation system, etc.) and some external factors (such as government policies, analysts, institutional investors, media, etc.) have the ability or motivation to constrain the behavior of the company. That is to say, these supervisory subjects have a supervisory effect on corporate earnings, so as to produce corporate governance effect. However, a few studies have analyzed and discussed how information technology will change the company's internal and external supervision cost and efficiency from the perspective of information technology application, and then how it will change the company's governance internally and externally.

To sum up, the existing literature has shortcomings in discussing the internal mechanism of the effect of information technology on corporate governance. Therefore, the relationship and mechanism between information technology and corporate governance can be explored in the future. By studying the action path of information technology to improve corporate governance by improving internal and external factors of corporate governance, it will be allocated an important position in promoting uses of IT to improve corporate governance and improve the level of enterprise performance.

### References

- [1] Bagais, O.A., and Aljaaidi, K.S. (2020) 'Corporate governance attributes and firm performance in Saudi Arabia', *Accounting*, pp. 923–930.
- [2] AlHares, A. (2020). 'Corporate Governance Mechanisms and R&D Intensity in OECD Countries', *Corporate governance (Bradford)*, 20(5), pp. 863–885.
- [3] Umamaheswari, D. (2020). ETHICS AND GOOD GOVERNANCE. *Delivering Justice: Issues and Concerns*.
- [4] GC, S. B., and Baral, R. P. (2019). 'The Effect of Corporate Governance and Ownership Structure on Financial Performance of Listed Companies in Nepal', *Journal of Nepalese Business Studies*, 12(1), pp. 1-18.
- [5] Jakpar, S., Tinggi, M., Johari, A., and Myint, K. T. (2019). 'Analysis of Corporate Governance and Firm Performance: Evidence from Malaysian Listed Companies', *International Journal of Business and Social Science*, 10(1), pp. 118-133.
- [6] Robinson, L., Marshall, G. W., and Stamps, M. B. (2005). 'Sales Force Use of Technology: Antecedents to Technology Acceptance', *Journal of Business Research*, 58(12), pp. 1623-1631.
- [7] Levillain, K., and Blanche S. (2019). 'From Primacy to Purpose Commitment: How Emerging Profit-with-Purpose Corporations Open New Corporate Governance Avenues', *European management journal*, 37(5), pp. 637–647.

Author: Jiajia Deng(1991.01—), Female, Han nationality, Xinjiang, Title: Lecturer, Education: Postgraduate, Research Direction: Management.

# Subtitle Translation of Coco from the Perspective of Communicative Translation Theory

Quanju Qiu, Mengru Xu

College of Foreign Languages, Shandong University of Science and Technology, Qingdao, Shandong 266590, China.

---

**Abstract:** In the context of globalization, the film industries of various countries have rapidly developed. China, while actively exporting its own films, has also imported a large number of excellent foreign films. As a result, film subtitle translation has become an important means of communication between different cultures. Considering the unique nature of film subtitles, it is crucial to ensure that the translation is clear, natural, and faithful to the original, so as to allow the target language audience to experience the same viewing effect as the source language audience. This aligns with communicative translation theory proposed by Peter Newmark. Therefore, this paper primarily adopts Newmark's perspective of communicative translation theory to analyze the English-Chinese subtitles of the film *Coco*. The aim is to summarize the methods, strategies, and techniques of subtitle translation, providing assistance and reference for future subtitle translation work. Conclusion has been drawn that the theory of communicative translation can guide subtitle translation to some extent.

**Keywords:** Communicative translation; Subtitle translation; *Coco*

---

## Introduction

The process of globalization has promoted the vigorous development of the film and television industry, leading to the emergence of excellent films and television works from various countries. As cultural carriers, films and television works bear the important responsibility of cultural exchange and dissemination. Therefore, subtitle translation plays a crucial role in this process. In 2017, the film *Coco* was released in China. It tells the story of Miguel, the protagonist, who embarks on a fantasy adventure to pursue his music dream after accidentally entering the land of the dead. Based on Newmark's communicative translation theory, this paper focuses on the English-Chinese subtitle translation of *Coco* as the research object. It aims to summarize the methods, strategies and techniques employed in subtitle translation, with the ultimate goal of promoting cultural exchange between China and foreign countries.

## 1. Newmark and Communicative Translation Theory

Peter Newmark, born in 1916, is a world-renowned translator whose translation theories and ideas have had a profound impact on the translation field, providing important guidance for translation practice. In 1981, Peter Newmark published his first work, *Approaches to Translation*, where he introduced two translation modes: semantic translation and communicative translation<sup>[1]</sup>. Unlike semantic translation, communicative translation focuses on the target language readers and emphasizes the effect of the translation. The core of communicative translation lies in conveying information according to the pragmatics of the target language, rather than simply replicating the wording of the source text<sup>[2]</sup>. Under the guidance of communicative translation theory, translations often exhibit characteristics of being easily comprehensible, standardized, and natural<sup>[3]</sup>.

## 2. An Overview of the Plot and Subtitle Translation of *Coco*

*Coco*, an animated film, beautifully showcases the vibrant colors of Mexican culture, with its most prominent feature being the incorporation of traditional elements from the Mexican Day of the Dead festival. The film revolves around the protagonist, Miguel, who passionately pursues his dreams of music and aspires to participate in the Day of the Dead music competition. However, his family opposes his musical aspirations. In a fit of anger, Miguel's grandmother destroys his guitar, leading him to run away from home. In order to participate in the competition, Miguel ventures into the tomb of the renowned musician, Ernesto de la Cruz, to steal a guitar. Unexpectedly, he mistakenly enters the land of the dead, embarking on a magical journey<sup>[4]</sup>. The intricate storyline eventually leads to a heartwarming and joyful conclusion. Miguel's unwavering determination not only earns the support and blessings of his family but also resolves misunderstandings among his loved ones. As a result, the family is reunited in harmony. The villainous Ernesto de la Cruz faces his rightful consequences, while Miguel's

great-grandfather, Héctor, who was unjustly killed, gains recognition from everyone. In the end, Héctor crosses the Bridge of Marigolds and reunites with his beloved daughter. The film's narrative covers themes of dreams, life, death, and family bonds, providing viewers with a profound experience to savor.

As an animated film that incorporates Mexican culture, *Coco* carries significant cultural connotations within its subtitles. Translators strive to use commonly understood words and expressions, given the quick and concise nature of film subtitles. They use short and flexible sentences to effectively convey information to the target language audience within the constraints of time and space<sup>[5]</sup>. By doing so, cultural differences between languages can be narrowed to some extent, enabling target language viewers to overcome barriers between English and Chinese and acquire a deeper understanding of the film's intended message. In this regard, Peter Newmark's theory of communicative translation can serve as a guiding principle for the subtitle translation of *Coco*. Therefore, this study focuses on the English and Chinese subtitles of *Coco* as the research object, analyzing the subtitle translation methods, strategies, and techniques in accordance with Peter Newmark's theory of communicative translation.

### **3. Case analysis of English-Chinese subtitles of *Coco* under the guidance of communicative translation**

Communicative translation aims to minimize the linguistic and cultural differences between the source language and the target language. When translating, translators employ various methods, strategies and techniques to ensure effective communication, optimize the transmission of information, and convey the intended message accurately to the target language readers.<sup>[6]</sup>

#### **3.1 Free Translation**

Free translation refers to translating the original text while not being constrained by its structure, yet still maintaining the core content. The purpose is to ensure conformity with the standards of the target language. Due to the differences in meaning, structure, and culture between English and Chinese, free translation is commonly employed by translators as the primary method. By using free translation, the information from the source language can be conveyed in a way that facilitates easier understanding for the target language readers, ultimately achieving the desired translation effect.

##### Example 1

ST1: I would move Heaven and Earth for you.

TT1: 我愿为你赴汤蹈火。

In example 1, “赴汤蹈火” (literally meaning “wade through boiling water and tread on fire”) is a metaphor for courageously moving forward despite difficulties and dangers. Chinese language often employs four-character idioms and colloquial sayings, thus communicative translation should adhere to the pragmatic mode of the target language. If the phrase “move Heaven and Earth” in the original sentence is strictly translated according to its literal meaning, it would be difficult to understand and could pose obstacles for the target language audience. Therefore, the translator chose to translate it as “赴汤蹈火” to capture the essence of the original message. Additionally, the form of using four-character idioms aligns better with the language expression habits of Chinese speakers, making it easier for the target language audience to comprehend the plot.

#### **3.2 Amplification**

Amplification is one of the common translation techniques used in English-Chinese translation. It involves adding words, phrases, or sentences based on the thinking, language habits, and expressions of both English and Chinese. This technique is employed while fully understanding and remaining faithful to the original text. Its purpose is to convey the meaning of the original more accurately and, to some extent, provide additional background knowledge to facilitate the understanding of the target readers.

##### Example 2

ST2: I thought it might have been one of those made-up things that adults tell kids, like...vitamins.

TT2: 我以为这又是一个大人骗小孩的故事呢，就像大人们说的，多吃菜长得快。

The original text depicts a scene where Miguel is astonished by the fantastical land of the dead. Miguel's realization of the existence of the world of the dead, as explained by the adults, is not a falsehood. Following the principle of communicative translation, the translator should fully supplement the meaning conveyed by "vitamins" to make the sentence structure more precise, enhance the clarity of the story's logic, ensure comprehensive information transmission, and assist the target audience in understanding the plot.

#### Example 3

ST3: We are not visiting your ex-wife.

TT3: 我们今晚才不会去你以前的老婆家过节。

The original text portrays a conversation between a couple in the land of the dead. Based on the story mentioned above, on the night of the Day of the Dead, the deceased return to their living families by crossing the Marigold Bridge. Following the principles of communicative translation, the translator supplements the original content to convey that the deceased couple is not visiting the ex-wife, but rather returning to the living world to celebrate the Day of the Dead. The use of amplification in subtitle translation ensures a more comprehensive and accurate rendition of the content, helping the target audience overcome the challenges posed by cultural differences between Chinese and Western languages while watching the movie.

### 3.3 Replacement

Replacement refers to the technique of using synonyms or alternative words to fulfill the requirements of language expression. When employing the replacement method, the translator should have a precise and comprehensive understanding of the lexical meaning. Undoubtedly, replacement is one of the significant approaches in subtitle translation. By appropriately utilizing replacement and carefully selecting the wording to be replaced, obstacles in translation can be eliminated.

#### Example 4

ST4: Miguel, eat your food. Aw, you're a twig, mijo. Have some more.

TT4: 米格，好好吃饭。瞧，你瘦的跟猴似的，多吃点。

The scene depicts the Miguel family dinner, where Miguel proudly displays his dimples to his grandmother at the table. Upon seeing this, his grandmother remarks on his need to eat well. Due to the disparity between English and Chinese metaphors, when describing someone who is relatively thin, English commonly uses the phrase "you're a twig", whereas Chinese employs the expression "你瘦的跟猴似的"(meaning "you are as thin as a monkey"). A literal translation such as "you are thin like a twig" in Chinese would not align with the expression habits of the target language readers. However, translating it as "you are thin like a monkey" not only conveys Miguel's skinniness but also underscores his clever and mischievous character, resembling that of a monkey. Hence, translators should take cultural differences into account and make appropriate substitutions.

#### Example 5

ST5: You took everything away from me! You rat!

TT5: 你夺走了我的一切，你这个小人！

Ernesto de la Cruz said to Héctor

The original text presents Héctor's accusation against Ernesto de la Cruz. In this context, the translator opts not to directly translate "rat" but instead substitutes it with "小人"(meaning "villain"), which vividly depicts Ernesto de la Cruz's character as someone who will stop at nothing to achieve his goals. Additionally, the word "villain" effectively conveys Héctor's intense hatred towards Ernesto de la Cruz. It can be observed that the judicious use of the replacement method not only helps to overcome cultural obstacles faced by the target audience while watching the movie but also enables a more compelling portrayal of the characters within the film.

### 3.4 Division

Division refers to a segmentation technique that aligns with Chinese expression and thinking patterns. Given the richness of vocabulary and limited adaptability of Chinese collocations and modifiers, it is important to select appropriate collocations and logical structures, express

them hierarchically, and divide them structurally during the translation process. Implementing division in translation helps avoid verbose and convoluted sentences, and to some extent, prevents the occurrence of translationese.

#### Example 6

ST6: Here in this plaza, the young Ernesto de la Cruz took his first steps toward becoming the most beloved singer in Mexican history.

TT6: 正是在这座广场上, 年轻的欧内斯托·德拉库斯迈出了他音乐事业的第一步, 最终成为了墨西哥历史上最受欢迎的歌手。

The source text serves as a narrator's introduction to the characters of Ernesto de la Cruz. English and Chinese exhibit significant differences, with English emphasizing structure and Chinese emphasizing meaning. During the translation process, the translator adheres to the pragmatic mode of the target language, rather than adhering strictly to the form of the original text. The translator follows the principle of communicative translation, which places emphasis on the target language. By adopting the division method, the translator translates a lengthy sentence in the source text into two shorter sentences. This approach helps avoid excessively long sentences that may pose difficulties for the audience to comprehend. It aligns with the writing standards of Chinese and reflects the characteristics of concise, clear, and easily understandable subtitle translation.

### 3.5 Conversion

Conversion involves transforming parts of speech, sentence patterns, and voice in the original sentence to align with the language habits of the target language. This includes converting parts of speech, word order, and voice. In communicative translation, the translator is tasked with conveying information in accordance with the language, culture, and pragmatic mode of the target language. The translation should conform as closely as possible to the language habits of the target language in order to achieve an optimal viewing experience. Word order conversion and part-of-speech conversion are common techniques employed in film subtitle translation.

#### Example 7

ST7: Cause of something that happened before I was born.

TT7: 因为我出生前发生了一些事。

In example 7, the reason his family didn't like music was that his great-grandfather had abandoned his wife and children to pursue his musical dreams, leaving his great-grandmother to raise their daughter alone. Due to the substantial differences in word order between English and Chinese, translators should adhere to the principle of communicative translation and adjust the original word order to match the target audience's preferences. Therefore, when translating, translators strictly follow the Chinese word order and may rearrange the original order as needed. This approach ensures that the translation is more easily understood by the audience and achieves a favorable viewing effect.

#### Example 8

ST8: He started out a total nobody from Santa Cecilia, like me.

TT8: 他最开始在圣塞西莉亚一点名气都没有。

The original text provides an introduction to Ernesto de la Cruz's life experiences before he achieved fame. In the original text, the term "nobody" functions as a noun, implying someone of little importance. The translator rendered it as a verb phrase in Chinese, "一点名气都没有", which successfully transformed the noun into a verb and enhanced the ease of understanding in the translation. This conversion aligns with the principle of communicative translation, which prioritizes the target language orientation.

### 3.6 Negation

Negation refers to the process of expressing statements in English from a positive perspective and translating them into Chinese from a negative perspective, or vice versa, where English statements are expressed negatively and translated into Chinese positively. The ultimate goal of this approach is to better align with the expression habits of the target language.

#### Example 9

ST9: She died way before I was born.

TT9: 我还没出生时, 她就过世了。

In example 9, the source text is an assertive sentence that Miguel introduces his great-grandmother Imelda to the audience. The literal translation in Chinese would be “我出生前，她就过世了。” However, in the official translation, “before I was born” is rendered as the negative form “我还没出生时”。 This translation choice aligns with the language expression habits of the target language audience and facilitates their understanding of the plot direction.

#### Example 10

ST10: You go home my way, or no way.

TT10: 想回家就得听我的话。

The original text is a dialogue between Miguel and his great-grandmother Imelda. Miguel has wandered into the land of the dead, and Imelda offers to send him back to the world of the living on the condition that Miguel gives up music. Miguel doesn't want to comply, but Imelda still utters these words. In the original text, “no way” conveys the meaning of “impossible” with a strong negative connotation. When translating, the translator renders it as positive sentences in Chinese, following the principle of communicative translation that prioritizes the target language. This translation expresses Imelda's stance against Miguel's pursuit of his musical dreams and effectively highlights Imelda's uncompromising personality.

## 4. Conclusion

This paper analyzes the subtitle translation of the film “Coco” under the guidance of communicative translation theory. From the perspective of communicative translation theory, translators have the flexibility to employ various strategies, methods, and techniques to convey the cultural aspects, emotions, and thoughts from the source language to the target audience more effectively. By minimizing cultural differences in subtitle translation, the aim is to provide the target audience with a viewing experience that closely resembles that of the source audience, thereby facilitating cross-cultural communication. In conclusion, communicative translation theory plays a crucial guiding role in the translation of film subtitles.

## References

- [1] She Xiaojie. On subtitle translation of *Scent of a Woman* from the perspective of communicative translation theory. *Movie Literature*. 2012; 566(17): 137-138.
- [2] Yang Junyan, He Lingjing. A Study on the English Translation of Chinese Culture-loaded Words in *Empresses in the Palace* from the Perspective of Communicative Translation. *Sinogram Culture*. 2021; (19) : 131-134.
- [3] Jia Yu. Research and Application of Communicative Translation and Semantic Translation. *Economic Research Guide*. 2013 (3) : 277-279.
- [4] Zhu Longrong. Research on Subtitle Translation Strategies for English Film of *Coco*. *Science and Technology Information*. 2022; 20(16):238-240+244.
- [5] Yang Yang. A Review of Film Subtitle Translation. *Journal of Southwest Jiaotong University (Social Sciences)*. 2006 (4) : 93-97.
- [6] Yin Li. The Application of Communicative Translation Strategies in Subtitle Translation —— A Case Study of *Game of Thrones*. *English Square*. 2022; 191(11):21-24.

# Couple Strength and Gentleness: Female Portrayal in Marriage and love Zaju of the Qing Dynasty

Beijie Ding

Tongji University, shanghai 200092, China.

---

**Abstract:** Zaju, an ancient Chinese literary genre that flourished during the Qing dynasty. With the progress of the times, the women in the marriage and love Zaju gradually overflowed with a consciousness different from the traditional norms of women's morality. They are the women who sacrificed themselves for their country, women who are even more talented than men, women who have to be prostitutes but with full of courage and knowledge. Couple Strength and Gentleness, which is an overview of Women in the Qing Dynasty, refers to women's indomitableness and tenderness. They have talents that are not inferior to those of men, at the time of national survival, they stepped forward, carrying the fate of the country, not humble, showing advanced concepts and self-awareness.

**Keywords:** Chinese zaju; Female image; Marriage and love; Qing dynasty

---

## Introduction

The Qing dynasty feudal monarchy centralised power, the ideological clampdown unprecedentedly strengthened, the literati are fear of violating taboos incurring the scourge of killing the family, so there are few free-thinking works in the zaju. Since ancient times, marriage and love zaju also became the picture of the writers to depict the pain of the heart, part of them, mostly in zaju to celebrate women's talent and knowledge, in order to ironise the male ignorance and uselessness. Against the backdrop of the Qing dynasty's cultural authoritarianism and rationalist indoctrination, women had to cater to the discourse of male power in order to survive, but they also gradually overflowed with a consciousness of female virtue that was different from the traditional norms of women's morality.

## Research Method

Literature analysis method, which is the most common research method in ancient Chinese literature. It mainly involves the collection and organisation of materials, and confirms the issues under study based on the information. The method requires scholars to go deep inside the text to discover deeper meanings that cannot be grasped by ordinary reading. This article uses the literature analysis method to analyse 95 marriage and love dramas of the Qing Dynasty, and sums up the representative female images into three categories, and then selects the representative women to be analysed, so as to show the female group portrait of the Qing Dynasty.

### 1. Great women for her country and for her people

In the Qing Dynasty, this kind of marriage zaju featured beautiful lady such as Wang Zhaojun and CAI Wenji. They loved their country, stood firm on justice, were concerned with the rise and fall of the country.

Wang Zhaojun is one of the four great beauties and has always been favoured by the literati. "Zhaojun zaju" is a female myth under the patriarchal society, carrying the dreams and demands of men for thousands of years.<sup>[1]</sup> The women's role in the zaju exposes the weak side of the male's extremely narcissistic cultural personality in a patriarchal society. You Dong's "Diao Pipa" portrayed Wang Zhaojun as a "loyal female" who lived in a social environment shrouded in male stereotypes and carried the fate of the country, eventually became a heroine admired by all generations. In "Diao Pipa", the setting is changed from "The Xiong Nu submitted to the Han Dynasty, and the Han Dynasty asked Wang Zhaojun to make peace with them" to "The Xiong Nu was aggressive, and the Han Dynasty was weak". As a result, Wang Zhaojun stands out against the incompetence of the civil and military authorities, the weakness of the Han Dynasty. The image of Wang Zhaojun was changed under the strong spirit of the Qing Dynasty, and the story of Zhaojun was constantly given new connotations, and the image of this woman was no longer an accessory under the rule of male power, but became a symbol of a nation.

The story of Cai Wenji is similar to Zhaojun's. In the fourth section of You Dong's "Diao Pipa", Cai Wenji mourns Wang Zhaojun, unfolding the feeling of sympathy between the two. Nanshan Yishi's "Zhonglangnv" highlights Cai Wenji's reflection on and criticism of the

“rampant party strife” in the Eastern Han Dynasty, changing Cai Wenji’s image of a gentle lady of the court, and unfolding the angry rebuke to the dimness of current affairs and the inaction of the righteous people. Nanshan Yishi was a victim of the Ming dynasty’s party struggle, and the party struggle was not unique to the Ming dynasty, but the only one whose party struggle was so intense and harsh that it could be compared to the end of the Ming dynasty was the Eastern Han dynasty.<sup>[2]</sup> In “Zhonglangnu”, Cai Wenji was ordered to compile and repair the history book, but was attacked by Yang Xiu and Liu Zhen, who are “Wenyuan Youth” and “Hanlin Leader”. Since ancient times, the renewal of history has always been a scholar male affair, Cai Wenji with a female’s body to take on this important task, is undoubtedly on the poor and incompetent scholarly irony.

Literary art is a reflection of real life. Realistic tragedy is the inevitable product of tragic times.<sup>[3]</sup> Throughout the long history of ancient times, it is filled with countless female tragedies. Some scholars believe that the four beauties are the base type of female image created by ancient Chinese patriarchal culture entirely with the semantic system of male manipulation, and coinciding with the patriarchal value system and aesthetic ideals.<sup>[4]</sup> The Qing dynasty’s marriage zaju reimagined these women, transforming the historical censure of the Four Beauties into women heroes who serve the country and the people, above and beyond men.

## **2. Women who are even more talented than men**

In the marriage and love zaju of the Qing Dynasty, such characters are represented by talented women such as Zhuo Wenjun and Xie Daoxun, who are sincere in their feelings and can bravely break through the heavy constraints for the sake of love.

Zhuo Wenjun, as a representative of talented women, has been praised for her and Sima Xiangru’s sincere relationship through generations of operas. But Shuwei’s “Zhuonv danglu” takes a different approach, starting with the story of Wenjun selling wine. Although Wenjun had no money after her elopement and had to sell wine, Sima Xiangru was ashamed to do so, but Wenjun was generous. Wenjun who has a clean, elegant and charismatic personality that is far superior to Sima Xiangru..

Wen Chaochao in “Gu hong ying” was deeply in love with Su Shi despite the age difference. Su Shi doesn’t love her, her unrequited love was fruitless, and eventually died with regrets. Wen Chaochao sacrificed her life to obtain the ideal love, expressing the concept of consistent love.

The four talented women portrayed in Hong Sheng’s “Si Chan Juan” are Xie Daoxuan, Wei Maoyi, Li Yi’an, and Guan Zhongji, all of whom are progressive women and advocate the equality of men and women. These four women not only did their talents exceed those of ordinary people, but their ideals in life were far higher than those of mediocre men. In Nanshan Yishi’s “Zhang Gong Mei”, Su Xiaomei can not only recite poems with her two talented brothers, Su Shi and Su Zhe, but she also makes difficulties for Qin Shaoyou on his wedding night, showing the image of a talented and clever young woman.

The Qing dynasty playwrights incorporated the depiction of female talent into marketplace life. Shen Meiniang which comes from Yan Tingzhong’s zaju, is extremely talented. she expresses the infinite depression and loneliness of her heart in beautiful language. Another outstanding woman who also come from Yan Tingzhong’s zaju named Hua Guanfang was top in the exams. By portraying Hua Guanfang’s talents, Yan Tingzhong is not only affirming women, but also challenging the traditional rituals of men’s superiority over women. He wants equality between men and women so that people with talents have room to fulfil their ambitions.

## **3. Women who have to be prostitutes but with full of courage and knowledge**

The women of the dusty world are also a group that cannot be ignored in the marriage and love zaju of the Qing Dynasty. They are forced to become prostitutes, with a low status and a difficult life. A part of them were respected and favoured by the literati because of their unique literary cultivation. In all the generations of marriage and love zaju, very few playwrights portrayed these women as heroines who were worried about the country and were not afraid of death. At the end of the Qing Dynasty, in the face of internal and external problems and the internal and external environment of life and death, the playwrights turned their viewpoint to the women at the bottom of the social stratum, and used the expression of their courage and indomitable qualities to warn the world and satirise the base person who were afraid of life and death.

The heroine whose name is of Ge Ruifang created by Wang Yunzhang, is a “woman of talent” who puts life and death at risk in the



face of national tragedy. She persuades Sun Wu to rise up against the enemy. She does not distinguish herself from the rich and famous, and not only ridicules the lowly pawns, she also attacks the general with a sword. Afterwards, Ge Ruifang attacked the general with a sword, and when she missed, she chewed her tongue and spat blood on the general's face to show her contempt for him and her loyalty. she is really a heroine who regards the rise and fall of the world as her own responsibility, and regards death as a homecoming.

The life of Sai Jinhua, the famous Suzhou prostitute in Yuan Zuguang's "Nie Haihua", is quite legendary. She devoted herself to country, but has been criticised by the people for committing herself to the Germans. As the officialdom of the late Qing Dynasty was corrupt, the existence of Sai Jinhua, a progressive woman, not only satirised the officials of all classes, but was also a metaphor for the nation and the times. The late Qing Dynasty, the invasion of the Western powers, the ruler's incompetence, the people suffer, even if the aspiring to serve the country, by their own strength is difficult to save the tide. Against this backdrop, the playwrights gave their passion to the Prostitutes in the zajus. Once women could only depend on men for survival, but now prostitutes are taking on the role of the state, which represents the breaking down of the institutional norms established under the feudal patriarchal background, and the feudal rites that have been deeply rooted in the hearts of the people for thousands of years have finally been buried in history.

## Conclusion

The female characters portrayed by the writers of the Qing dynasty's marriage and love zajus have left behind the traditional perspective of focusing on love. If using phrase to summarise the female group in the Qing dynasty's marriage and love zajus, it should be "Couple Strength and Gentleness". The term "Couple Strength and Gentleness" refers to the fact that although a woman is weak, she contains the spirit of flexibility that can't be pressed or bent. Qing dynasty marriage and love zajus, in a certain sense, can not be separated from the limitations of the times and authors, but if you use the perspective of that time, you will see that female have made great progress, they are no longer like flowers, objects like people enjoy, but really into the community, show talent, the pursuit of independent personality and freedom and dignity.

## References

- [1] Yang Huiling. An Alternative Interpretation of the Ancient Zhaojun Opera[J]. Chinese Self-study Guide, 2008.
- [2] Zhao Yuan. Studies on the Scholars in the Ming and Qing Dynasties[M]. Beijing: Peking University Press, 1999.
- [3] Jiao Wenbin. A Treatise on Classical Chinese Tragedy[M]. Lanzhou: Northwest Normal University Press, 1990.
- [4] Qian Guolian. Wang Yanwei, Reinterpretation of the Four Great Beauties of Ancient China's Images in Feminist Perspective[J]. Journal of Zhejiang University of Technology, 2006.

# Research on the Energy-Saving Design Idea of Mechanical Design and Manufacturing and Its Automation

Jinlong He

Xihua University, Chengdu, Sichuan 610039, China.

---

**Abstract:** With the continuous development of global industry, the field of mechanical design, manufacturing and its automation is facing increasingly severe energy and environmental pressure. In order to solve the problem of energy consumption and environmental pollution, this paper with energy saving design ideas as the core, in the material selection as the research object, by optimizing the material selection, using advanced numerical control technology and green processing technology, put forward a series of solutions, aims to provide reference for mechanical design and manufacturing and automation practitioners, promote the industry towards more sustainable and energy saving direction.

**Keywords:** Mechanical design and manufacturing; Automation; Energy-saving design ideas

---

Introduction: Mechanical design and manufacturing and its automation play a vital role in promoting the development of industry. However, with the rapid development, it also faces serious problems in energy consumption and environmental pollution. In order to better solve this contradiction, this paper introduces the idea of energy-saving design into each link of mechanical design and manufacturing, paying special attention to material selection, numerical control technology and green processing process, aiming to improve the efficiency of energy utilization and reduce the environmental burden.

## 1. Mechanical planning and its automation features

Mechanical planning is a kind of manufacturing process to complete the workpiece processing by mechanical means, and its core characteristics lie in high efficiency, accurate and controllable. First of all, mechanical planning pays attention to precision, through precision mechanical system and advanced control technology, can achieve micron level processing accuracy, to ensure the quality of products. Secondly, mechanical planning has a high degree of automation characteristics, which can automatically perform processing tasks through computer programs, improve production efficiency, and reduce manual intervention. In addition, mechanical planning has the flexibility, can adapt to different processing needs, through the adjustment of procedures and process parameters to achieve multi-variety, small batch production. In general, mechanical manufacturing, through automation and precision machining, has brought about revolutionary changes to the manufacturing industry and promoted the continuous development of industrial manufacturing.

## 2. Mechanical design and manufacturing and the application of automatic energy-saving design idea

### 2.1 Optimize the product structure and function

In terms of product structure, adopting lightweight design is a key measure. By using advanced materials with high strength and low density, such as carbon fiber composites, we can reduce the product weight, motion inertia and energy loss on the premise of ensuring the strength. For example, carbon fiber materials are widely used in the aerospace field to make aircraft structures lighter, reduce flight resistance and improve fuel efficiency. Secondly, in terms of product function design, through the application of intelligent technology, accurate control and adaptive adjustment are realized, so as to match the actual working condition requirements to the maximum extent. For example, smart sensors and advanced control systems can monitor the running state of equipment, adjust working parameters in real time and avoid unnecessary energy consumption. In the manufacturing industry, the introduction of programmable logic control (PLC) system realizes the intelligent management of the production line, and the production speed and energy consumption are adjusted on demand<sup>[1]</sup>. At the same time, optimizing the product structure and function also includes improving the product maintainability and manufacturability. The modular design makes the parts easy to replace and repair, prolong the product life and reduce the waste. This design concept is in line with the concept of

circular economy, and helps to reduce resource waste and reduce energy consumption.

## **2.2 Optimize the design scheme**

Reasonable selection of power system is an important aspect of optimizing the design scheme. Using efficient electric motor, engine or other power plant, can improve the energy conversion efficiency. For example, instead of the traditional internal combustion engine drive, the choice of electric drive system not only reduces the energy loss, but also reduces the noise and emissions, in line with the trend of modern green and energy saving. At the same time, through system integration and intelligent control, optimized energy management. Advanced adaptive control algorithm, predictive maintenance and energy recovery technology will enable the system to automatically adjust the operating state according to the actual load and working conditions to avoid unnecessary energy consumption. For example, factory automation systems in intelligent manufacturing can adjust the operating status of equipment in real time according to production requirements, and minimize energy waste during idle periods. In terms of structural design, adopting the optimized mechanical structure and transmission system is also an important strategy. By reducing the friction loss and improving the transmission efficiency, the energy loss in the power transmission process can be reduced. Advanced materials and structural design such as bearings and transmission belts are adopted to reduce the internal resistance of the system and improve the overall operation efficiency<sup>[2]</sup>. In addition, considering the energy consumption in the life cycle of the product, the whole life cycle energy saving of the design scheme is realized from the perspective of sustainability. This includes product manufacturing, operation, maintenance and scrap stages, comprehensive consideration of the energy efficiency of the system, to promote the development of circular economy.

## **2.3 Use of virtual design technology and mechanical equipment automation technology**

Virtual design technology plays a key role in the product development process. With tools such as computer-aided design (CAD) and computer-aided engineering (CAE), engineers are able to simulate, analyze, and optimize products in a virtual environment. For example, in aircraft design, hydrodynamic simulation can optimize the aircraft shape, reduce air resistance, and reduce fuel consumption. Virtual design technology enables engineers to deeply optimize the system before the actual manufacturing, thus reducing the cost of trial and error and improving the accuracy of the design. At the same time, the application of mechanical equipment automation technology can achieve a high degree of intelligent and efficient in the manufacturing process. Automated production lines can use sensors, machine vision and machine learning technologies to monitor and adjust production parameters in real time to adapt to different working conditions and needs, thus reducing energy waste and fluctuations in production efficiency. For example, an automobile manufacturer introduced an automated assembly line to quickly and accurately assemble parts through intelligent robots, improving production efficiency and reducing the rejection rate. The integration of virtual design technology and mechanical equipment automation technology is also reflected in the maintenance and operation stage. Through remote monitoring and maintenance systems, predictive maintenance can be performed before equipment problems, reducing downtime and improving equipment stability and reliability.

## **2.4 Optimize the material selection in mechanical products**

Using high-strength and lightweight materials is a common strategy to optimize material selection. For example, aluminum alloy, compared with traditional steel, has higher strength and lower density, and can be used in automobile, aircraft and other fields, to reduce the weight of the vehicle and improve fuel efficiency. At the same time, fiber reinforced composite materials are also an important choice for lightweight design, such as carbon fiber composites are widely used in aircraft, automobile and other fields to reduce the structural quality and improve the mechanical performance. Secondly, considering renewable materials and recycling is an important way to achieve sustainable development. By selecting biodegradable materials, recycled materials or materials that can be easily recycled, resource consumption is reduced and the burden on the environment is reduced. For example, some plastic products use biodegradable materials to help reduce the environmental impact of plastic waste. In addition, optimizing the surface treatment and coating technology is also the way to improve the material performance. By using the coating with corrosion resistance and wear resistance, the life of the material can be extended and the energy

waste caused by the material aging can be reduced. For example, the use of advanced surface coating technology, such as nano-coating, can form a protective film on the surface of mechanical parts, improve wear resistance, reduce friction resistance, and reduce energy consumption<sup>[3]</sup>. Finally, through the life cycle assessment, comprehensively consider the energy consumption and environmental impact of materials in the procurement, production, use and scrapping stages, and select the materials most consistent with the concept of sustainable development.

## 2.5 Promote the energy management system

The establishment of a comprehensive energy monitoring system is a key step in promoting the energy management system. Through the introduction of high-precision sensors and monitoring equipment, real-time monitoring of equipment operation status, energy consumption and other data, to form a comprehensive energy use data, to provide a basis for the subsequent energy management and optimization. For example, the installation of power monitors, gas flowmeters and other equipment on industrial production lines can monitor the consumption of electricity and gas in real time. Secondly, the advanced data analysis and artificial intelligence technology are used to process the monitoring data. Through big data analysis, the energy management system identifies potential energy waste points, and conducts predictive analysis through artificial intelligence algorithm to optimize the production plan and equipment operation parameters. For example, through machine learning algorithms, the system can learn the working mode of the device, realize the dynamic adjustment of the device performance, and improve the overall energy efficiency. Third, implement the intelligent control strategy of the energy management system. By integrating PLC (programmable logic controller), SLC (monitoring and data acquisition system) and other automation technologies, realize intelligent control of the production line. The energy management system can automatically adjust the parameters of the operation state and production speed of the equipment according to the production demand to avoid unnecessary energy waste. For example, an intelligent lighting system can automatically adjust the lighting intensity according to the actual lighting situation in the working area to reduce energy consumption. In addition, the promotion of energy management systems also requires staff training and awareness improvement. By training employees to use and understand the energy management system, stimulate their awareness of energy conservation, encourage them to participate more actively in energy management and optimization work, establish incentive mechanisms, and reward employees for innovation and proposals in energy conservation.

Conclusion: With the introduction and popularization of advanced technology, the field of mechanical design and manufacturing and automation also needs continuous innovation and optimization. Building a green and efficient machinery manufacturing system is our goal. Actively explore the innovation and application of energy-saving design ideas, strengthen the green processing technology and other measures, will lay a foundation for the realization of sustainable development. We should strengthen technology research and development, improve the independent innovation ability of the industry, and make contributions to the overall development of the field of mechanical design and manufacturing and automation.

## References

- [1] Yu Wenxia. Analysis of the application methods of energy-saving design concept in mechanical manufacturing and its automation [J]. Shihezi Technology, 2023 (04): 32-34.
- [2] Wang Xiaochuan. Discuss the energy saving design idea of mechanical design and automation [J]. China Equipment Engineering, 2023 (11): 115-117.
- [3] Luan Zhongshi. Analysis of the application methods of energy-saving design concept in mechanical manufacturing and its automation [J]. Modern Manufacturing Technology and Equipment, 2022,58 (09): 190-192 + 203.

# Thinking and practice on the teaching reform of “sensor technology” course from the perspective of ideological and political education

Jun Chen, Hongbing Meng \*, Andi Yang, Jianming Xu

School of Information Engineering, Tarim University, Alar 843300, China.

---

**Abstract:** Sensor and testing technology is a key link to cultivate students' logical thinking and practical ability, which plays an irreplaceable role in quality education. This paper takes the course of “sensor technology” as a breakthrough point, from the standpoint of teaching reform, the professional training requirements and traditional teaching methods are analyzed, and it is elaborated, and the specific reform is carried out, in order to provide some reference for the relevant education personnel, so as to build a more modern, more effective classroom. Give full play to students' ability of innovation and imagination.

**Keywords:** Ideological and political education in curriculum; Sensor technology; Curriculum teaching; Reform

---

## Introduction

With the continuous deepening of quality education and new curriculum reform, compared with the past, the government's macro demand for school classrooms has undergone a more significant adjustment and change, from the simple recitation of theoretical knowledge as the focus, more attention to the development and training of skills, which also provides a clearer idea for teachers' innovation. Sensor principle and application is an important part of electronic specialty, occupies a very important position in the whole basic curriculum system, its goal is to make students have a comprehensive understanding of the measurement and control, computer application, electronic information and other aspects of knowledge, so as to improve the students' ability to design and innovate the application of products.

## 1. Disadvantages of the traditional teaching model of “sensor technology” course

### 1.1 Theoretical courses are overemphasized, while experimental courses are mostly confirmatory

In the past, the sensor principle and application courses were carried out in the way of combining theory with practice. Theoretical teaching mainly told about the principle, structure, characteristics, measurement lines, error analysis and other aspects of the sensor, and the application characteristics were very obvious. In the experimental teaching, the output characteristics of the sensor are tested, such as pressure, displacement, motor speed, temperature and humidity, etc. If the appropriate processing of all kinds of information after the test, it is bound to have a certain impact on the accuracy and objectivity of the test results, which will also affect the students' understanding and mastery of the sensor.

The course of “sensor technology” is based on the professional basic courses such as digital mode and electricity, which is more theoretical. Many teachers have a kind of “theoretical teaching in the textbook first” illusion. For this reason, they spend a lot of time to teach students the theoretical knowledge, but, for a long time, the university's sensor teaching is based on the textbook. Spend a lot of time in some basic principles, simple application of professional knowledge, based on demonstration teaching methods. However, due to the fixed time of the course setting, the practical operation training of related courses is less, and the main focus is on verification experiments, which restricts students' thinking ability.

### 1.2 Teaching evaluation is not scientific and reasonable

At present, some universities have obvious bias in the experimental assessment, mainly through the writing of basic experimental reports to evaluate the experimental results of students, which has a great distance from the sensor principle and application of the actual operation, and even can not reflect the overall learning status, can not reflect the real actual operation. Therefore, in the teaching evaluation of “sensor

technology” in universities, there is a great irrationality and lack of scientific nature, so that the real teaching results can not be tested, on the contrary, the teaching results and the real teaching objectives have a great deviation, the actual development of students has caused a great impact.

## **2. Thinking on the teaching reform of “sensor technology” course from the perspective of ideological and political education**

### **2.1 Explore the classroom teaching method**

In the course of sensor principle and application, the traditional teaching model is to deduce the theory first, and then verify it through experiments. In theory teaching, because there are many mathematical derivations, it is boring, which is not conducive to the verification of experiments. In order to enable students to better grasp the relevant knowledge in the whole class, we have carried on the appropriate adjustment to the traditional teaching idea -- starting from the application, taking the specific task as the guidance, carrying on the theoretical study. The project-based teaching method is different from the traditional teaching method. It aims to make the students fully participate in the whole process of the innovation project, so that they can better understand the theoretical knowledge they have learned. As a teacher, we should change our educational concept, change our teaching methods, from simple teaching knowledge to active guidance, and consciously cultivate creative thinking. “Subject research” is based on “subject”, and the study of “subject” is an important subject of “subject” research. When applying, you can refer to the national, provincial and municipal university electronic design competition, Internet of Things, robot competition and other outstanding projects. The difficulty of the project should be appropriate, teachers should have an overall understanding of the overall process of the project, to ensure that students can complete the project independently, this is indeed an effective way to encourage students to participate in the project. In order for students to get used to learning in a project and task style as soon as possible, every student must be able to participate in it. According to the students’ interests and research direction, teachers can divide students into groups of 3 or 4 students to ensure that each student has the opportunity to participate. Teachers should break down the tasks of innovative projects, provide specific and effective guidance to students from the perspectives of the significance of project establishment, hardware circuit design, measurement data processing, improvement and prediction, improve students’ thinking ability, hardware circuit design ability, guide them to establish and debug hardware circuit, and guide students to write a project concluding report after the project is over. So that the students can not only improve their theoretical level, but also exercise their practical ability. Through the research of this subject, it not only enriches the teachers’ theoretical knowledge, but also promotes the enthusiasm of the students to participate in the research of the subject. In addition, teachers can also study and visit brother colleges to learn from experience and lessons, or participate in academic conferences and achievement fairs, introduce the current scientific research projects to students, and enrich students’ knowledge. For example, teachers can introduce interesting experiments such as food fullness detection, pulse detection and environmental noise detection to students in class to stimulate their subjective initiative in learning.

### **2.2 Reform of examination methods**

Changes in teaching methods will inevitably lead to changes in evaluation methods. In order to adapt to the new professional quality requirements, to make classroom teaching and innovative activities organic combination, it is necessary to build a variety of learning effect evaluation system. Changing the traditional examination method with attendance rate and writing homework as the main content, to research learning in the classroom question and answer assessment, through the teacher’s questions, rush to answer, discussion, homework, small papers, quizzed and other methods to better understand the students’ learning status, and to timely adjust the teaching content and methods, so as to obtain better teaching effect. At the same time, we also encourage students to actively carry out research learning after class to enhance their innovative thinking. After the implementation of project-task teaching method, the evaluation of innovative projects becomes very important. In the form of defense and project report, the main members of the project group make project statements, other students ask questions and score related issues in the project, and each group finally writes a written report to sort out and summarize the whole process of the project. And it should be included in the evaluation of the project results, so that each student can play the greatest potential, the students’

learning enthusiasm into a positive spirit of exploration, and truly realize the application of what they have learned. The final examination is also very critical, abandoning the traditional terminology explanation, abandoning the simple concept question and answer and multiple choice questions, focusing on the basic theory and application ability of sensors. Through the reform of teaching evaluation methods, the students' learning enthusiasm has been maximized, and the shortcomings of "mechanical memory" and "no use" caused by the previous examination methods have been overcome, which truly reflects the students' practical application ability.

### 2.3 Cultivate college students' subjectivity

In the teaching process, teachers should combine theory and experiment with practice, so that students can develop the habit of independent thinking and can complete the experiment independently. For example, in teaching, teachers can let students design a simple sensor signal regulation circuit, and guide students to conduct in-depth analysis of its application. On this basis, the experimental teaching can be divided into verification experiment and design experiment. The purpose of verification experiment is to make students understand the usage and calibration method of the sensor, so that students can understand the operation of the interface circuit, and have a more comprehensive understanding of it in the exploration, and then design experiment. In addition, in the introduction of theoretical courses, teachers should also give students assignments, provide them with an open experimental platform, so that they can choose a kind of sensor to carry out the design of small systems, from the selection of sensors, to the debugging of signal lines, to the construction of digital circuits of analog circuits, to be completed by students themselves.

## Conclusion

Continuously promoting the teaching reform of "sensing and detection" course is a rational and necessary measure, which can not only give full play to the innovation ability of students, but also effectively adjust the classroom organization form. This paper discusses the ideas and measures of curriculum reform from the aspects of cultivating interest, introducing engineering examples, making multimedia animation courseware, expanding practice and so on. It is reasonable in theory and feasible in practice to integrate professional basic knowledge closely with it, which fully reflects the main role of students in the classroom and can provide reference for teachers.

## References

- [1] Song Xiang; Wang Jing; Jiang Huilin; Xu Qimin. Exploration of "Sensor" curriculum reform with multi-dimensional ideological and political elements [J]. Journal of Electrical and Electronic Teaching, 2021
- [2] Zhang Rong-bo. Thinking and exploration of ideological and political construction of sensor Technology curriculum [J]. Industry and Science and Technology Forum, 2021. (in Chinese)
- [3] Ye C C; Xu Yanping; Zhang Hua; Wu Yifan; Wang Yunlu. Curriculum Ideological and Political Construction in the teaching of sensor and sensor Network [J]. Computer Education, 2021

Foundation Project: The Corps first-class undergraduate Program of Tarim University (22000032717); "Sensor Principle and Application" (22010030910), a first-class undergraduate course of Tarim University; And the Ideological and political demonstration team of "Sensor Principle and Application" course, Tarim University (TDKCSZ12305).

Author: Chen Jun (1992-), male, native of Dingxi, Gansu Province, master, lecturer, his research interests include embedded systems and Internet of Things engineering.

Corresponding author: Meng Hongbing (1967-), male, native of Alar, Xinjiang, Master degree, Professor, Director of the Department of Electronic Communication, his research interests include agricultural information engineering and intelligent control.

# The Impact of Residential Mobility on Altruistic Behavior

Wei Jian Fu

Guangxi Normal University, Guilin 541000, China.

---

**Abstract:** This paper summarizes the relationship between residential mobility and altruistic behavior. This paper expounds the present situation of the floating population in China and the world. The feasible path of providing psychological support to the floating population is proposed, including the psychological support scheme closely following the characteristics of the floating population, the cultivation of targeted talents and the popularization of online psychological support methods, so as to promote the research on the floating population.

**Keywords:** Residential mobility; Altruistic behavior; Social support

---

## 1. Introduction

### 1.1 Residential mobility

With the economic and social development and internationalization of human societies in the last few decades, population mobility has greatly increased, especially in developing countries in Asia and Africa (International Organization for Migration, 2015). Socio-ecological psychology captures this phenomenon well (Oishi, 2014). Residential mobility has become a common experience for people in most parts of the world.

Residential mobility (RM) refers to the frequency with which people change residence and is typically characterized by changes in residential space and the construction of new social networks (Oishi, 2010). The study of residential mobility has a long tradition: geographers, sociologists, economists, and psychologists have contributed extensively to the literature on the process of residential mobility and its relationship to changes in urban structure. The most frequently cited work is Rossi's (1955) classic, *The Causes of Household Migration: a Socio-Psychological Study of Urban Residential Mobility*.

Brown and Moore's (1970) article is another frequently cited work that focuses on the decision of families to move. They divide the mobility process into two stages. In the first stage, there is dissatisfaction with the current housing situation as the family environment or its composition changes. The current housing situation creates pressures that eventually lead households to the second stage: searching for vacancies in the housing stock and deciding whether to move or stay in their current residence.

### 1.2 Altruistic behavior

Pro-social behavior is often defined as unofficially directed behavior intended to benefit another person, such as sharing, helping, or even trying to help another person. Pro-social behaviors may be motivated by many different reasons, including concern for others, an expectation of recognition or reward, a desire to comply with norms or perceived responsibilities, or out of a belief in fairness or justice. Altruistic behavior, a subtype of pro-social behavior, is generally defined as voluntary behavior that is intrinsically motivated to benefit others, including behavior that arises out of concern for others or internalized values, goals, and self-rewards, rather than the expectation of specific or social rewards-avoidance of punishment and disapproval (Eisenberg & Mussen, 1989).

Many theories have been proposed about the origins, emergence, and changes in altruistic behavior. Inclusive adaptation theory and the reciprocal altruism explanation (Hamilton, 1964) have led a generation of researchers to embrace as the standard answer that what appears to be altruism-personal sacrifice on behalf of others-is really just long-term egoism. However, recent experimental research has revealed forms of human behavior, including interactions between unrelated individuals, that cannot be explained by egoism. One such feature, which we call strong reciprocity (Henrich, 2001), is the tendency to cooperate with others and punish violators of cooperative norms at personal cost, even though it is impossible to expect that these costs will be repaid by others or at some later point in time.



## 2. The relationship between residential mobility and altruistic behavior

The role of neighborhood environment in behavioral health has recently become a prominent focus of research and policy. Research in the field of child development has found that pro-sociality (O'Brien et al. ,2011; Wilson et al. ,2019), aggressive behavior (Ingoldsby & Shaw 2012; Molnar et al. ,2014), juvenile delinquency (Sampson et al. 1999), mental health (Xue et al. ,2015), and behavioral problems (Edwards & Bromfield ,2019) have all been associated with characteristics of the neighborhood environment. Studies have found that these effects are independent of a wide range of individual variables, from demographics to family parenting practices, suggesting that neighborhoods help influence early life experiences of development. However, such studies are often cross-disciplinary, and the phenomena they demonstrate may be dominated by the experiences of people who have lived in their neighborhoods for most of their lives. At the same time, they are unable to determine whether children who have already had significant social experiences in another setting are affected by the characteristics described above.

To explore this issue, a study tracked the behavioral development of an urban adolescent population, some of whose families had moved within the city. Thus by paying special attention to changes in pro-sociality, defined as behaviors and attitudes that benefit others or the group as a whole. Prosociality is the key to obtaining social resources for oneself and is central to the well-being of the community, providing for the construction and maintenance of social networks and the basis for collective endeavors (Putnam, 2010).

O'Brien (2011) provided an evolutionary developmental model of individual altruistic behavior, suggesting that early life experiences can be used to guide development towards locally adaptive social strategies (Belsky, 1991). Evolutionary theorists have long argued that the success of pro-social strategies depends on the presence of social partners who are similarly pro-social, give back to others, and participate equally in cooperative ventures (Wilson & Wilson, 2017). Thus, the pro-social development of young people depends on the quality of the local social environment. Using the same sample that served as the basis for the current study, the authors tested this model in Binghamton by measuring altruistic behavior and social support from a variety of sources (family, school, extracurricular activities, religion, and community). This series of studies adds to the body of research that suggests an association between quality relationships with adults and adolescent altruism (Romano et al., 2015; Wilson & Csikszentmihalyi, 2017; Wilson et al., 2009). Furthermore, changes in altruistic behavior over time parallel changes in all forms of social support.

Unrelated to neighborhood effects, residential moves have the potential to adversely affect the development of altruistic behaviors because they often disrupt the social relationships of all members of the household (Pribesh & Downey, 1999). Research with adolescents suggests that those who move frequently report having fewer friends and being less popular (Petit, 2004; South & Haynie, 2014). In addition, they may lack adult social support as their parents are less likely to have met their friends' parents (South & Haynie, 2014), an important component of intergenerational cohesion (Coleman, 1990). This means that altruistic behavior declines for all movers, independent of the neighborhood in which they live. However, this effect may be weakened if the move is closer (Magdol & Bessel, 2013).

### 2.1 Current situation of residential mobility of university students

#### 2.1.1 Current status of residential mobility in the United States and in the world

In the pursuit of happiness, millions of Americans move to a new city each year to get a better education or find a better job (Florida, 2002). In addition, millions of Americans are choosing to retire in pursuit of a better quality of life. This trend is likely to increase as 27% of Baby Boomer respondents indicated that they are fairly certain they will move to a new city when they retire (AARP, 2004). This finding is not surprising considering that residential mobility is a defining characteristic of American culture (Oishi & Kisling, 2009). What is surprising is that residential mobility is no longer confined to the United States - a land of opportunity known for its relentless pursuit of happiness. People across the globe are increasingly moving to new cities, countries, and even continents in pursuit of a better quality of life. According to the World Migration Report (International Organization for Migration, 2015), 175 million international migrants live in countries different from where they were born in 2000, up from 76 million in 1960. Recognizing that residential mobility is a key factor in globalization and increasing economic and social integration around the world, the United Nations Secretariat now holds regular high-level meetings on the subject (for example, international migration and development was discussed on August 11, 2008 at the United Nations General Assembly).

As migration becomes a common experience for most people, and even a way of life for some people around the world, it is crucial to understand precisely how residential mobility affects mindsets and behaviors. Especially in the new context of global public security, where population mobility may cause deterioration in social security and where altruistic behavior is an important factor influencing the social climate, it is important to fully explore the relationship between residential mobility and altruistic behavior and ways to improve it.

### *2.1.2 Current situation of residential mobility in China*

China is currently a socialist primary stage society undergoing a profound transition to a market economy and experiencing dramatic urban change (Huang & Deng, 2006). In socialist Chinese cities, residential mobility within mainland China was low prior to the reform and opening up in 1978 due to a welfare-oriented housing system and a public sector that was almost equivalent to lifetime employment. After the reform and opening up, especially the urban housing reform initiated in 1988, new forces were unleashed for profound changes in all aspects of society, including an unprecedented increase in residential mobility in China and a growing number of individuals with experience of residential mobility. Currently, the rate of residential mobility in China continues to grow rapidly, and even with the impact of the global epidemic crisis since 2020 (Zhang, 2021), the overall mobility trend remains unchanged. The trend of population mobility in China tends to be from rural to urban areas, and the number of migrants from rural to urban areas has been increasing year by year, but China has been practicing a dual urban-rural household registration system, which may lead to unequal or stereotype-laden treatment of rural migrants in urban areas (Chen et al., 2020), which may in turn result in psychological problems for individuals with a lot of experience of mobility (Nelson et al., 2020). According to intervention studies on the subject, individuals who are frequently mobile lead to a decrease in altruistic behavior (Zhang & Wu 2018). A Chinese social survey also showed that the altruism of the mobile population is generally lower than that of the low-mobility population (CGSS, 2017). Therefore, paying attention to the psychological problems of the mobile population and enhancing the altruistic behavior of the mobile population is a measure of great significance for the long-term development of society.

## **3. Suggested Measures to Address Low Altruistic Behavior of Highly Resident Mobile Populations**

### **3.1 Exploring Psychological Support Programs for China's Resident Mobility Population**

How to prevent psychological problems and low altruistic behaviors among the high residential mobility population, and how to improve and intervene in this regard is the focus of our social psychology research today. We need to develop psychological support programs that are suitable for China. The first step is to develop appropriate psychological support programs that take into account the mobility and life characteristics of high-occupancy migrants. Currently, the characteristics of China's migrant population are often due to work or study reasons for mobility, migrant people often psychological pressure and a sense of belonging is not strong reaction is more obvious (Deng et al., 2014). Therefore, the relevant units accepting migrant individuals can carry out regular psychological support activities for migrant individuals. Through individual or group specialized support activities, individuals can accurately identify negative emotions and develop a sense of belonging to the mobile destination. Promote the application of psychological support in the daily situation of mobile individuals, and ultimately enhance the psychological state and altruistic behavior of mobile individuals. Second, a tracking pilot study will be conducted on the characteristics of the high-residence migrant population; through long-term tracking, the main factors affecting the altruistic behavior of the migrant population will be identified, and targeted and tracked intervention methods will be developed.

### **3.2 Nurturing counterpart psychological professionals**

Due to the continuous development of social economy, China's mobile population is increasing, and the shortage of psychological talents is growing. In order to promote the psychological support for the migrant population, it is indispensable to cultivate talents with professional qualities. Professional psychology practitioners who provide psychological services for mobile populations should not only have a firm grasp of the basics of psychology, but also have a sufficient understanding of the concept of social ecological psychology of residential mobility, and have a wealth of practical experience to understand the psychological impact of large numbers of mobility on individuals, and to be able to prescribe the right medicine to enable mobile populations to obtain accurate psychological support, which is a key factor in the

development of psychological services for mobile populations. This is the basic requirement for professional psychology practitioners who provide psychological services to migrant populations(Quartiroli et al., 2022). First of all, we should make full use of social resources, selecting professionals to attend professional teacher training at universities and colleges or formal institutions, building professional teams, and cultivating backbones capable of performing front-line psychological support work and guiding psychological counseling. In addition, units with the conditions can also organize mobile people to experience psychological support through hospitals, welfare institutions and other authoritative institutions, to pave the way for the occurrence of their altruistic behavior. On the basis of psychological knowledge, we can consciously screen and cultivate professionals to promote the care and support for the highly residential migrant population in China.

### 3.3 Popularize online psychological support functions

A good psychological state is an important foundation for promoting altruistic behavior. First, the popularization of online psychological counseling support can effectively alleviate the current shortage of psychological services for the highly mobile population in Chinese society. Although Chinese society has made great progress in psychological services for the migrant population in recent years, the construction of grassroots psychological services is still unable to meet the demand for psychological services for the migrant population at this stage. The lack of specialized personnel and the large number of service groups have raised higher requirements for psychological services for the Chinese migrant population. Providing a variety of healthy and positive self-adjustment methods for the general psychological problems of China's migrant population can not only help China's migrant population ease their psychological problems and prevent the emergence of migrant population's psychological crises, but also effectively alleviate the current situation of China's insufficient service strength of social psychological support. At the same time, online self-help psychological counseling support can avoid some of the worries and concerns of the migrant population about psychological counseling, protect the privacy of the migrant population, enhance the motivation of the migrant population to participate in psychological support counseling, and at the same time, provide practical methods to ensure the psychological support of the migrant population. The second is to actively integrate online psychological support into social education. Through the network, the knowledge of psychological support and altruistic behavior is transmitted and psychological guidance recordings are provided at the same time, based on the popularization of psychological support and the cultivation of altruistic behavior, to guide the high mobility people to positively face and accept the psychological feelings and experiences of life in different social environments, to cultivate the sound personality of the mobility people, and to improve the psychological quality of the mobility people(Di Carlo et al., 2021).

## 4. Conclusion

As an emerging research direction in social psychology, the relationship between residential mobility and altruistic behavior is a topic worth exploring. An in-depth study of this relationship can give us deeper insights into how to promote individual altruistic behavior. The mobile population is a unique feature of our time, we should pay more attention to the mobile population, explore the causes and influences of their behavior, find out the problems, and explore solutions to improve the psychology and behavior of the mobile population.

## References

- [1] Belsky, J., Steinberg, L., & Draper, P. (1991). Childhood experience, interpersonal development, and reproductive strategy: An evolutionary theory of socialization. *Child Development*, 62, 647–670.
- [2] Brown, L. A., & Moore, E. G. (1970). The intra-urban migration process: a perspective. *Geografiska Annaler: Series B, Human Geography*, 52(1), 1-13.
- [3] Chen, S., Yang, J., Yang, W., Wang, C., & Bärnighausen, T. (2020). COVID-19 control in China during mass population movements at New Year. *The Lancet*, 395(10226), 764-766.
- [4] AARP. (2004). *Baby Boomers Environ Retirement II: Survey of baby boomers' expectations for retirement*. Washington, DC: AARP.
- [4] Coleman, J. (1990). *The foundations of social theory*. Cambridge, MA: Harvard University Press.
- [5] Deng, Z., Mo, X., & Liu, S. (2014). Comparison of the middle-aged and older users' adoption of mobile health services in China. *International journal of medical informatics*, 83(3), 210-224.

- [6] Di Carlo, F., Sociali, A., Picutti, E., Pettorruso, M., Vellante, F., Verrastro, V., ... & di Giannantonio, M. (2021). Telepsychiatry and other cutting-edge technologies in COVID-19 pandemic: Bridging the distance in mental health assistance. *International journal of clinical practice*, 75(1).
- [7] Dieleman, F. M. (2001). Modelling residential mobility; a review of recent trends in research. *Journal of housing and the built environment*, 16(3), 249-265.
- [8] Edwards, B., & Bromfield, L. M. (2019). Neighborhood influences on young children's conduct problems and pro-social behavior: Evidence from an Australian national sample. *Children and Youth Services Review*, 31(3), 317-324.
- [9] Eisenberg, N., & Mussen, P. H. (1989). *The roots of prosocial behavior in children*. Cambridge University Press.
- [10] Florida, R. (2002). *The rise of the creative class*. New York: Basic Books.
- [11] Hamilton, W. D. (1964). The genetical evolution of social behaviour. II. *Journal of theoretical biology*, 7(1), 17-52.
- [12] Henrich, J., Boyd, R., Bowles, S., Camerer, C., Fehr, E., Gintis, H., & McElreath, R. (2001). Cooperation, reciprocity and punishment in fifteen small-scale societies. *American Economic Review*, 91(2), 73-78.
- [13] Huang, Y., & Deng, F. F. (2006). Residential mobility in Chinese cities: A longitudinal analysis. *Housing studies*, 21(5), 625-652.
- [14] Ingoldsby, E. M., & Shaw, D. S. (2012). Neighborhood contextual factors and early-starting antisocial pathways. *Clinical Child and Family Psychology Review*, 5(1), 21-55.
- [15] Magdol, L., & Bessel, D. R. (2013). Social capital, social currency, and portable assets: The impact of residential mobility on exchanges of social support. *Personal Relationships*, 10(2), 149-169.
- [16] Molnar, B. E., Browne, A., Cerda, M., & Buka, S. L. (2014). Violent behavior by girls reporting violent victimization: A prospective study. *Archives of Pediatric and Adolescent Medicine*, 159, 731-739.
- [17] Nelson, S., Zhushchikhovskaya, I., Li, T., Hudson, M., & Robbeets, M. (2020). Tracing population movements in ancient East Asia through the linguistics and archaeology of textile production. *Evolutionary Human Sciences*, 2, e5.
- [18] O'Brien, D. T., Gallup, A. C., & Wilson, D. S. (2010). The Role of Social Resources in Adolescent Prosocial Development: A Longitudinal Study at a City-Wide Scale. *THE DEVELOPMENT AND EXPRESSION OF POSITIVE SOCIAL BEHAVIORS IN URBAN SETTINGS*, 86.
- [19] Oishi, S. (2014). Socioecological psychology. *Annual review of psychology*, 65, 581-609.
- [20] Oishi, S., & Schimmack, U. (2010). Residential mobility, well-being, and mortality. *Journal of personality and social psychology*, 98(6), 980.
- [21] Oishi, S., & Tsang, S. (2022). The Socio-ecological Psychology of Residential Mobility. *Journal of Consumer Psychology*.
- [22] Oishi, S., Ishii, K., & Lun, J. (2009). Residential mobility and conditionality of group identification. *Journal of Experimental Social Psychology*, 45, 913-919.
- [23] Pettit, B. (2004). Moving and children's social connections: Neighborhood context and the consequences of moving for low-income families. *Sociological Forum*, 19(2), 285-311.
- [24] Pribesh, S., & Downey, D. D. (1999). Why are residential and school moves associated with poor school performance? *Demography*, 36, 521-534.
- [25] Putnam, R. (2010). *Bowling alone: The collapse and revival of American community*. New York: Simon and Schuster.
- [26] Quartiroli, A., Wagstaff, C. R., Zakrajsek, R. A., Knight, S. M., & Etzel, E. F. (2022). The role of self-care and professional quality of life in sustaining a long-lasting career in sport psychology: A qualitative exploration. *Journal of Applied Sport Psychology*, 34(6), 1334-1351.
- [27] Romano, E., Tremblay, R., Boulerice, B., & Swisher, R. (2015). Multilevel correlates of childhood physical aggression and prosocial behavior. *Journal of Abnormal Child Psychology*, 33(5), 565-578.
- [28] Sampson, R. J., Raudenbush, S. W., & Earls, F. (1999). Beyond social capital: Spatial dynamics of collective efficacy for children. *American Sociological Review*, 64, 633-660.

[29]South, S. J., & Haynie, D. L. (2014). Friendship networks of mobile adolescents. *Social Forces*, 83(1), 315–350.

[30]Wilson, D. S., & Csikszentmihalyi, M. (2017). Health and the ecology of altruism. In S. G. Post (Ed.), *The Science of altruism and health* (pp. 314–331). Oxford: Oxford University Press.

[31]Wilson, D. S., & Csikszentmihalyi, M. (2017). Health and the ecology of altruism. In S. G. Post (Ed.), *The Science of altruism and health* (pp. 314–331). Oxford: Oxford University Press.

[32]Wilson, D. S., O'Brien, D. T., & Sesma, A. (2009). Human prosociality from an evolutionary perspective: Variation and correlations at a city-wide scale. *Evolution and Human Behavior*, 30, 190–200.

[33]Wilson, D. S., O'Brien, D. T., & Sesma, A. (2019). Human prosociality from an evolutionary perspective: Variation and correlations at a city-wide scale. *Evolution and Human Behavior*, 30, 190–200.

[34]Xue, Y. G., Leventhal, T., Brooks-Gunn, J., & Earls, F. J. (2015). Neighborhood residence and mental health problems of 5- to 11-year-olds. *Archives of General Psychiatry*, 62(5), 554–563.

[35]Zhang, J., & Wu, L. (2018). The influence of population movements on the urban relative humidity of Beijing during the Chinese Spring Festival holiday. *Journal of Cleaner Production*, 170, 1508-1513.

[36]Zhang, R., Liang, Z., Pang, M., Yang, X., Wu, J., Fang, Y., ... & Qi, X. (2021). Mobility trends and effects on the COVID-19 epidemic—Hong Kong, China. *China CDC Weekly*, 3(8), 159.

# From the Perspective of Rural Revitalization, the Existing Building Reconstruction Ideas of Rural Regional Culture are Applied

---- take The Former Site of Liangxi Primary School in Wangcun as an Example

Yitong Wang

Shaoxing University, Shaoxing 312000, China.

---

**Abstract:** Socialist rural revitalization road regional culture is the most attractive and the most summary characteristics, in the modernization construction, is also the soul of regional development. However, at present, the performance and prominence of local regional culture are often ignored in the beautification and transformation of new rural areas, which leads to the weak integration of the existing rural buildings, the natural landscape and local life, and the lack of regional characteristics. At present, experts, scholars and architectural planning designers all realize that the construction of beautiful countryside needs to fully reflect the local cultural elements according to the local cultural background, and the application of regional culture is very wide, which reflects the local humanistic spirit, cultural characteristics and social customs in the design. However, it still needs to strengthen the innovation of expression and the in-depth research on the connotation of regional culture and spirit. This paper discusses how to apply regional culture to the reconstruction of existing buildings under the perspective of rural revitalization.

**Keywords:** Rural revitalization; Regional culture; Reconstruction of existing buildings; Socialism with Chinese characteristics

---

## Introduction

The fundamental feature of the socialist road of rural revitalization with Chinese characteristics lies in China's national conditions, taking care of China's rural reality, and valuing Chinese cultural traditions <sup>[1]</sup>. Building a beautiful countryside is an important measure to implement the guiding principles of the 19th CPC National Congress <sup>[2]</sup>. Rural revitalization and beautiful rural construction are both for the construction of countryside. The former puts forward rural development strategies from various perspectives, and puts forward the need to pay attention to Chinese cultural tradition, the latter focuses on how to build a rural environment suitable for living, work and tourism, and puts forward the construction concept for rural life, production and ecology. The combination of the two puts forward development goals for rural construction and needs to pay attention to regional cultural resources. At present, the performance and prominence of rural culture are often ignored in the beautification and transformation of new countryside, which leads to the weak integration of rural beautification and transformation with natural landscape and local life and the lack of regional characteristics. The most intuitive reflection is the reconstruction of existing rural buildings in the countryside. Regional culture carries people's nostalgia memory, and the expression of regional characteristics is of great significance in the construction of beautiful countryside <sup>[3]</sup>. The transformation of existing rural buildings provides a carrier for the embodiment of regional culture. Starting from the local characteristics, we should fully excavate and give play to the existence and the long history, and build buildings reflecting regional characteristics, so as to realize the actual benefits of beautiful rural construction.

Many experts, scholars and architects agree that the construction of beautiful rural landscape needs the protection and expression of regional culture, but there are still doubts about how to practice it. This paper borrowed from the architectural design of the whole and system thinking planning and design technique, put forward for the regional cultural communication meet barriers, the existing regional cultural landscape performance does not reach the designated position, landscape construction hard and cannot bring practical effect, how to borrow the landscape industry planning overall consciousness construction with the characteristics of regional culture beautiful countryside. Colleges and universities are involved in rural revitalization. With the deepening of rural revitalization, colleges and universities orderly organize teachers and students to participate in the reconstruction and optimization of old rural buildings through courses,

competitions and other forms.

## **1. Why should the construction of beautiful countryside pay attention to the application of regional culture**

Regional culture is the most attractive and summative feature of the region, and in the modernization construction, it is also the soul of regional development. Regional culture needs to be paid attention to in the construction of beautiful countryside, because its culture is a necessary support point for sustainable economic development, the focus of promoting the bloom of China's diverse culture, and the basic driving force for the development of urban and rural areas in China.

### **1.1 Regional culture enhances cultural understanding and cultural confidence**

Traditional regional culture is the concrete embodiment and carrier of locality, and is an important way to understand and understand locality<sup>[4]</sup>. Nowadays, the social development is becoming increasingly global, and the development of globalization is gradually invading human culture and civilization, resulting in a serious influence on both local culture and regional culture. Through the construction of beautiful countryside, highlight the regional cultural personality, subtly influence the absorption of local and foreign residents to local culture, is the most effective way to spread regional culture, but also to enhance the understanding of culture and cultural identity, is one of the ways to enhance cultural confidence corresponding to the development trend of globalization.

### **1.2 Regional culture to promote sustainable rural development**

Protecting regional cultural characteristics is to highlight the personalized differences of beautiful villages, which plays an important role in respecting traditional culture and carrying forward the national spirit. Secondly, it can reduce the homogenization and equalization of rural areas and expand the openness of rural areas. As an important part of the development of beautiful countryside, the reconstruction of existing buildings has a high degree of dynamic artistry. Chinese traditional regional characteristics, coupled with the local agricultural production and the lifestyle of the rural population, are forming a series of new choices and reorganizations with ethnic characteristics. Through the creation and presentation of the buildings and surrounding landscapes, it fully reflects the local living customs and aesthetic habits, and also improves the cultural spirit behind the design, which has a certain dissemination, and can promote the sustainable development of rural economy and culture.

### **1.3 Universities and art are involved in rural revitalization**

Colleges and universities are involved in rural revitalization. With the deepening of rural revitalization, colleges and universities orderly organize teachers and students to participate in the reconstruction and optimization of old rural buildings through courses, competitions and other forms. Art and design intervene in rural revitalization. Zhejiang has always produced a large number of celebrities, and has a profound accumulation of poetry and art. At present, Shilu Zhejiang has become an important program for building a beautiful Zhejiang. The involvement of art and design in the construction of beautiful countryside has become a hot topic of continuous social attention. The way of art and design involvement in rural revitalization can be roughly divided into two stages: one is the construction of rural scenic spots, which promoting the renewal and quality shaping of existing rural buildings,<sup>[5]</sup> such as Guyan painting township, Zhejiang Sanmen sketching base, Zhejiang Longmen Ancient Town sketching base, etc.; the second is the design competition to promote rural landscape planning and scenic spot design, so as to drive the development of rural tourism, among which the design results of Anji and Songyang are significant. In order to make the bamboo industry and bamboo design into the construction of beautiful countryside in China and the United States and boost the development of the bamboo industry, the Anji Government held the Anji University Bamboo Design and Construction Competition. The excellent works of the competition have become the places for local people to hold various cultural activities. Songyang's first Rural Revitalization National Design Competition focuses on the local idle houses and land, and the creative design of the buildings and environment in the old streets and old villages. These examples provide a lot of practical experience for the study of this project, and the local culture and materials should be fully explored to build a multi-functional space that is conducive to rural development and villagers' life.

## **2. Existing problems in the application and practice of regional culture in the construction of beautiful countryside**

### **2.1 Meet the barriers of regional cultural communication**

With some beautiful rural landscape of the main demonstration area for interpretation object, from the implementation of the design concept to the layout and methods of the space are conventional landscape ecological means design, and the traditional ecological landscape project mainly consider for a variety of entertainment experience, and often a single landscape ecological planning to promote the spread of regional culture way is relatively single.<sup>[6]</sup> Regional culture is a limited symbol in the limited time of art, which needs to convey the charm of rural local culture in the form of a real artistic space and with a clear and artistic quality. Therefore, on the basis of respecting nature, we must rationally plan and update the content of the project, introduce historical buildings, cultural resources and cultural symbols, and introduce public art activities. Combined with the development needs of rural towns, building a well-structured rural landscape development framework in the field of new elements of public art also brings new opportunities for the development of rural tourism.

### **2.2 The transformation of regional cultural buildings is rigid and uniform**

The buildings that have been transformed are not coordinated and connected with the surrounding natural environment, the overall atmosphere is not effective, there are some phenomena such as not respecting the local natural climate, geographical landforms, folk customs, and some even destroy other surrounding characteristic landscapes. Without the sense of history of public life, the design itself has lost its culture, and culture is separated from the growing soil, becoming water without a source and a tree without roots, making the overall rural style stiff and uniform.

### **2.3 The reconstruction of existing buildings in regional culture has no practical effect and benefits**

The concept of regional culture participation is relatively weak, blindly paying attention to the beauty of appearance and form. The close gap between design and traditional cultural elements and the regional environment ignores the spiritual and cultural needs of the public. If more people have only a superficial visual experience, then the derivation of architecture stops.<sup>[7]</sup> Japanese designer Sasaki stressed that the design should pay attention to public participation, fully sharpen the local characteristics in the design, and create the architectural art of symbiosis between man and nature. If we just design the visual beauty, we will lose the landscape and bring more value to us. Good public engagement can better satisfy different people and define different recreational activities. Participation is often related to distance and accessibility, which also directly affects people's interest in participating in various recreational activities. If visitors do not well engage and experience the regional culture, they will lose interest in continuing visits, reduce the number of visitors, and lose a large number of visitors. The effective combination of knowledge and participation can strengthen the communication between regional culture and tourists, and give full play to the interest of teaching function. Attention to the combination of these two kinds is just to give more attention and attention to our future design, so as to better play and enhance the democratic side of architecture and give life to architecture.

## **3. How to apply regional culture in the construction of beautiful countryside- -Take the transformation of liangxi Primary School in the author's graduation design as an example**

Understanding the countryside is the first step in the application of regional culture. From the designer or government personnel involved in the construction of beautiful rural environment, the exploration of the original site has started.<sup>[8]</sup> The meaning of "phase land" can be simply summarized as the comprehensive observation and exploration of the use of land landscape. Then, the overall site landscape is comprehensive, reflect the characteristics of the site, in line with the site development needs of the theme (design theme). However, due to the pursuit of rapid output, it often only pays attention to the existing state of the material space of the site while ignoring the arrangement and disassembly of cultural characteristics, or does not analyze the causes of the formation of the material space of the existing site without any repair or reconstruction. This requires the comprehensiveness and precision of the purpose. Different from other types of construction, rural construction plans the customer group including the residents living in the site and the ecological environment in the site. With the de-



velopment of time, it is necessary to comprehensively analyze its rural characteristics and explore the available themes.

### 3.1 Regional culture excavation

3.1.1 The Five craftsman culture is in decline, looking for the right opportunity. Shangwang village craftsman culture atmosphere is rich, the village five craftsmen: carpenter, stone carpenter, mason, bricklayer, painter, bamboo carpenter. With the development of the era of science and technology, there are fewer and fewer craftsmen, and the younger generation lacks the opportunity to understand the craftsmen, leading to the decline of the five craftsmen culture in Shangwang Village. Because the village is currently engaged in the most staff, and shangwang village is rich in bamboo resources, so the main craftsman culture and the research complex after the reconstruction of Shuangxi Primary School.

3.1.2 Villages like to learn calligraphy, carry forward the calligraphy culture. Shangwang Village is a descendant of Wang Xianzhi. A large number of villagers like learning calligraphy. They can integrate calligraphy into the base and put it into the painting and calligraphy exhibition hall and calligraphy study room.



(Figure 1) Portrait of Wang Xianzhi (Figure 2) Intention map of studying calligraphy (Figure 3) Shangwang Village Painting and Calligraphy Exhibition

### 3.2 Excellent design cases, the excavation

3.2.1 flat tamura show space farming pavilion and manual workshop, is the waste idle old rammed earth houses transformation, make it a flat tamura use a high frequency of cultural communication space, pay attention to the design of uneven space fusion, and retain the original building of regional cultural elements, and the surrounding environment;

3.2.2 Lanshu Shanfang B & B in Xiang Langshu Village, the organic integration of B & B with ancient trees and ancient roads. The design will be scattered in the mountains, fit the terrain extension. With ancient trees for neighbors, with terraces;

3.2.3 Chenjiapu Village Cultural Space Pioneer Bookstore, the design focuses on borrowing the exterior scenery of the mountain and integrating the building with the mountain. The plan is also to retain the pattern of the log structure and the rammed earth exterior wall. Materials abide by the local principles, the use of plaster, log, hemp rope commonly used rural materials combined with metal, glass and other rich texture materials of the traditional wood structure place and modern space characteristics linked together.

To sum up, the above cases are of great reference value to my space culture conception and the specific space design form. Compared with this design, I think this project can be discussed in depth from the following three aspects. First, this design should pay attention to the coordination of spatial nodes and the overall environment of Shangwang Village. In the above three cases, the harmony between the building and the surrounding environment, such as the retention of rammed earth walls on the facade and the selection of local materials for the space nodes, which should not be ignored in the project and the continuity between functions in the aspect of functional replacement. For example, in the case of Pingtian Village, the farming hall and the hand workshop show the continuity of experience functions after the function. For example, terraces and ancient trees to connect private space and public space; third, in the spatial landscape design, the interior and outdoor landscape. For example, Xianfeng Bookstore pays attention to the integration of buildings and mountains in Chenjiapu Village, and builds a viewing platform outside. According to the above three aspects, the project is reasonable and innovative design.

### 3.3 Integrate creative ideas into regional cultural elements

Using Shaoxing landscape layout and Chinese traditional scenery concept. In Shaoxing, in several historical gardens, such as Lanting and Zhujiahua Garden, square pools are all adopted, which has become a major feature of the local landscape art in Shaoxing. These layout planning and elements are appropriately used in the courtyard space to form the courtyard relying on the landscape of Shaoxing.<sup>[9]</sup> From the overall layout, the step of the scenery, the courtyard around the square pool, the bridge and rockery in the courtyard is the epitome of shang-wang village landscape, in the viewing platform or in the building, borrow the scenery of the base; the base surrounded by mountains on three sides, in the base to the east and west and the south, can borrow the natural resources around the base. Using the modern building transportation system, put into the grand staircase, the ground to the roof are connected, pay attention to the spatial connectivity.

### 3.4 Use regional culture

The theme of this plan is the rural research complex, which is dominated by teachers and students from universities, taking into account the catering and accommodation of tourists, and radiates the villagers' cultural activities. The theme is divided in the following four sections.

One is the research and study travel base. Objective In order to inherit the memory of bamboo culture and promote the transformation of village economy. The target population is for teachers and students. The second is the endless classroom outside the school. Objective In order to provide diversified education, enrich extracurricular natural experience and increase cultural pride in traditional crafts. The target population is for teachers and students. The third is the villagers' cultural activities, the purpose is to enrich the life of the villagers, drive the revival of bamboo sticks, the craftsmen in the village to show their skills. The target population is the villagers. The fourth is the catering and accommodation for tourists, in order to promote the local economic development, improve the utilization rate of the base. The target population is the tourists.

## 4. Epilogue

The application of regional culture in the reconstruction of existing rural buildings can be mentioned and thought of by everyone, but how to show the local flavor in place needs repeated verification and practice. In the process of practice, should break the subject barriers, using the perspective of interdisciplinary summarize and analyze rural regional characteristics, with the overall system thinking, is not only to the building and the repair of the surrounding environment, also need to consider rural social relations, considering rural regional culture (different types of cultural connotation) in the "people, ground, scene, production" the use of four aspects, with different discipline method running rural characteristics, finally realize the construction of beautiful countryside. Every village has its own characteristics, and the reconstruction of the existing buildings in the countryside should be designed according to the characteristics of the countryside itself. Before the design, it is necessary to fully investigate the base and the village where the base is located to understand the real needs of the countryside and give full play to the value of reuse of idle space.

## References

- [1] Xu Wei. The characteristics and practical paths of socialist rural revitalization with Chinese characteristics [J]. Journal of Central South University for Nationalities (Humanities and Social Sciences Edition), 2020,40 (03): 145-151.
- [2] Yang Bin. Research on the Rural Governance of the Communist Party of China in theNewEra[D].SouthwestJiaotongUniversity,2019.DOI:10.27414/d.cnki.gxnju.2019.002554.
- [3] Fan Li, Zhu Xiaomin, Zhang Ying, Zhang Hong, Zhou Tao. The expression of regional characteristics in the construction of Chengdu's beautiful countryside [J]. Journal of Sichuan Tourism College, 2019 (04): 61-65
- [4] Wang Yuncai. The graphic language and its heritage of the traditional regional cultural landscape [J]. Chinese Gardens, 2009,25 (10): 73-76.
- [5] Zhai Hui. Rural planning: looking for rural catalyst [J]. Western Journal of Habitat Environment, 2016,31 (02).
- [6] Where. Cultural memory in localization: the "writing" of rural cultural landscape takes the cultural study of "Qingshan Hutong" as an example [J]. New Fine Arts, 2020,41 (11).
- [7] Canal rock. Art township construction: the third path of China's rural construction [J]. National Art, 2020, (03).
- [8] By Jin Xuezhi. Chinese Garden Aesthetics, 2nd edition [M]. Beijing: China State Construction Press, 2005.08.

# Research on the Supply of Public Cultural Services in Bayanhot Town

Yakun Wang, Cuiying Yu

Inner Mongolia Agricultural University, Hohhot 010000, China.

---

**Abstract:** Our Government has proposed to improve the public cultural service supply system as soon as possible, to promote the deep-level development of public cultural service supply, and to establish a new model of cultural co-construction and sharing. This paper takes Bayanhot Town as an example to investigate and study the current situation of public cultural service supply in border areas, development dilemmas and reasons for countermeasures. Bayanhot Town has actively promoted the construction of public cultural service supply in recent years, but there are still problems such as limited resources and insufficient financial investment, Bayanhot Town still needs to strengthen the construction of public cultural service supply. Research on the construction of public cultural service supply in Bayanhot Town is of great significance in promoting the deep-level development of local public cultural service supply. It is conducive to the effective supply of regional public cultural services, the diversification of the form and content of public cultural service supply, and the promotion of the diversified development of public cultural service supply.

**Keywords:** Bayanhot town; Public cultural service provision; Public cultural services

---

## Introduction

Our Government has conducted a number of meetings explicitly proposed “to enhance the level of public cultural services” and made a series of major deployments, into the 14th Five-Year Plan, a series of policy documents issued to ensure the efficient development of public cultural service provision. Inner Mongolia Autonomous Region 14th Five-Year Plan puts forward, to vigorously promote the development of public cultural undertakings, industries, and further promote the improvement of the level of public cultural services. Bayanhot Township is located in the westernmost part of Inner Mongolia, and in recent years, it has begun to achieve results in the field of public cultural service supply, but it still faces many difficulties. Promoting the development of public cultural service supply construction in Bayanhot Town is conducive to safeguarding the basic cultural rights and interests of the masses.

## 1. Bayanhot town public cultural services supply existing problems

Alxa League 14th Five-Year Plan proposed: to promote the modernization of the cultural service system, and promote the steady improvement of the level of equalization of basic public cultural services in the region. However, there are many problems with the current public cultural service provision in Bayanhot Township.

### 1.1 Insufficient funding for public cultural service provision

According to the “Alxa Left Banner Bayanhot Township People’s Government 2020 Departmental Budget Public Report”, Bayanhot Township 2020 general public budget financial allocation of 18.7634 million yuan, the specific use of the following: for the general public service category expenditure of 9.2481 million yuan, accounting for 49.29%; agriculture, forestry and water category expenditure of 9.5666 million yuan, accounting for 51%; social security and employment category expenditure of 1,444,500 yuan, accounting for 7.7%; health expenditure of 648,400 yuan, accounting for 3.46%; housing security expenditure of 1,011,800 yuan, accounting for 5.34%, while the expenditure on culture, sports and media amounted to 314,600 yuan, accounting for only 1.68%. These data fully reflect that because of the long time since the spiritual and cultural construction is marginalized, and thus even if the government spends most of its finances on people’s livelihood issues, the public cultural services are still in a low development status, and the financial investment is still relatively small.

### 1.2 Insufficient construction of public cultural service personnel

In most cases, public cultural service practitioners will directly face the public to answer questions about public cultural services,

whose level of specialization and service attitude will directly affect the public's perception of and attitude towards the entire public cultural service supply system in the region. <sup>[1]</sup>Community public cultural service practitioners are relatively scarce, it is understood that a community has only three official staff responsible for the daily work of the community. Most communities lack professional public cultural service practitioners, and volunteers are highly mobile, with no fixed staff or fixed working hours, which also leads to difficulties in the provision of public cultural services.

### **1.3 Multi-subject governance has yet to take shape**

The government has not yet established a long-term and efficient interaction mechanism with the market, social groups and other non-governmental organizations, and there is a lack of specific policies and measures to attract and motivate social and economic forces to participate in the provision of public cultural services, so the degree of pluralistic governance of the provision of public cultural services is low. Individual citizens have limited time and energy, and there are no more suitable channels to participate in the provision of public cultural services, so public participation is low. From the viewpoint of social organizations, public welfare groups only account for a small part, and most of the enterprises and organizations will not fully invest in the supply of public cultural services for the sake of interests, so the effect of governance by multiple subjects is not obvious.

## **2. Countermeasures for Public Cultural Service Provision under the Perspective of Multi-subject Governance**

The supply of public cultural services has become an important part of China's social management, and we need to continue to explore how to build a system of benign interaction of diversified market players in social public services, so as to continuously improve the management level of the supply of public cultural services. The following countermeasures are proposed to address the existing problems in Bayan-hot Township.

### **2.1 Increase financial support, broaden the fund-raising channels**

The town government should establish a financial guarantee system for the supply of public cultural services and strengthen financial support to a certain extent in order to guarantee the completion of the regional public cultural service system. As the main provider of public cultural services, the government should formulate institutional policies in accordance with its characteristics and needs to ensure the smooth development of public cultural undertakings. It is necessary to actively guide private investment and encourage extensive investment from all sectors of society, <sup>[1]</sup> to provide financing support for the construction of a new type of public cultural service provision mechanism, and to further accelerate the expansion of the scale of funding for the provision of public cultural services. The establishment of a financing mechanism for public cultural services and the encouragement of social forces to participate in the construction of the public cultural service supply system. <sup>[1]</sup>

### **2.2 Promoting the building of public cultural service teams**

Establishing a sound system for the discovery, training, motivation and evaluation of public cultural service teams, and forming a system for the cultivation of high-level, high-quality talent. Absorbing specialized cultural service personnel and further optimizing the team structure, in order to ensure that urgently needed social talents and senior technicians are brought in, retained and put to good use. Through the implementation of training programs for the public cultural service industry's talent team, combining specialization and part-time training, train a team of public cultural service industry talents with high professional standards and a strong sense of social responsibility. Further optimize the structure of the professional layout of vocational <sup>[1]</sup> and technical colleges and universities in the region <sup>[1]</sup>, enhance the comprehensive strength of higher education to support the development of regional culture, and promote the continuous innovation of local training mechanisms.

### **2.3 Promoting the governance of public cultural service provision by multiple actors**

Government departments have reoriented their roles in the provision of public cultural services, gradually changing from being

all-powerful in the past to being dominant and managerial, and guiding group organizations to participate in the provision of public cultural services. Insist on the principle of leadership by the people's government and joint governance by multiple social forces. Multiple subjects must work together, make choices together, and manage the supply of public cultural services together<sup>[1]</sup>. Each subject should face up to its own responsibilities and obligations in the supply of public cultural services in the region, actively participate in the governance of the supply of public cultural services, realize the advantages of advantages among multiple supplying subjects, and form a synergy in the supply of public cultural services.

### 3. Conclusion

With the improvement of the level of social and economic development, people's cultural needs are increasingly diversified, more and more eager and happy to participate in the process of public cultural services, the government also had to people this new cultural demands into policy considerations, began to pay attention to the social orientation of public cultural services<sup>[1]</sup>. Bayanhot town should be based on regional realities, in-depth understanding of the new requirements of modern public cultural service provision, improve the level of public cultural service provision. Insist on maintaining the fundamental interests of the people as the starting point and finishing point of development, establish and improve the public cultural service system, and constantly enhance the people's sense of access and happiness, and promote social development and progress.

### References

- [1] Wang Ping, Li Shuyang. Researches on Public Culture: Starting from Its Basic Concepts. *Library Tribune*.2022,42(05):79-85.
- [2] Cui Na, Liang Xiangming. On the Accessibility of Public Cultural Service from the Perspective of Governance. *Zhejiang Social Sciences*.2021(10):81-86+158.
- [3] Zhang Xiaofei, Li Zi. Research on the Collaborative Participation Mechanism in Modern Public Cultural Service System. *Library science research work*.2020(10):5-10.
- [4] Han Hui, Yuan Shuo. The Measurement of China's Public Digital Cultural Service Supply Efficiency From Multiple Perspectives. *New Century Library*.2023(08):88-97.
- [5] LI Guoxin. Promoting the Development of Inclusive Non-basic Public Cultural Services. *Document, Information & Knowledge*.2022,39(05):6-11.
- [6] Zhao Junyi, Li Shaohui. From Public Cultural Service to Public Cultural Governance. *Library Journal* .2022,41(09):4-11.

# Duolun County Resource and Environmental Carrying Capacity Study

Su Ri Ge Ri Le Tu, A Ru Han

Inner Mongolia Agricultural University, College of Desert Control Science and Engineering, Hohhot City 010010, China.

---

**Abstract:** Resources and the environment are the material basis for human survival and development. In the context of building an ecological civilization, the evaluation of the carrying capacity of resources and the environment has become an important basic task in the preparation of the new round of territorial spatial planning. This paper selects the typical ecologically fragile area of Duolun County, Inner Mongolia, as the study area, and utilizes literature, spatial data, socio-economic statistics, and land use secondary classification data to construct a resource and environmental carrying capacity evaluation index system that includes three subsystems: resources, environment, and socio-economy, and analyzes the resource and environmental carrying capacity of Duolun County, Inner Mongolia, in the period from 2005 to 2020, at the temporal and spatial scales for the 65 administrative villages in the Duolun County, Inner Mongolia, and the area of the county.

**Keywords:** Duo Lun county; Resource and environmental carrying capacity; Administrative village domain

---

## Introduction

Resource and environmental carrying capacity can directly reflect the degree of coordination between human social development, daily life, production and resource environment <sup>[1]</sup>. The mode and direction of demographic, social and economic development of a region also depend on the carrying capacity of its resources and environment. To realize the sustainable development of regional socio-economics, it is necessary to effectively protect and improve the resource environment <sup>[2]</sup>, so as to realize the coordinated development between various resource elements. As society continues to move forward, limited resources and unlimited demand are important and serious tests for future socio-economic development. Since the reform and opening up of the Inner Mongolia Autonomous Region continued rapid social and economic development, the people's living standards have also been gradually improved, to a certain extent, the resource environment has paid a great price. At the same time on the excessive, disorderly development and utilization of resources and too fast development mode of the region's resources and environment caused serious damage, so how to coordinate the resources and environment and socio-economic development of the contradictions between the promotion of regional sustainable development has become a necessary path to resolve the contradictions, and the resource and environmental carrying capacity to match the various types of resource elements has become an important way to achieve this purpose <sup>[3]</sup>. Based on the actual situation of Duolun County, Inner Mongolia, the evaluation study of resource and environmental carrying capacity is carried out, which provides suggestions for the future social, economic and ecological construction of Duolun County, and focuses on the reasonable protection and development and utilization of land resources while promoting the urban and rural socio-economic development of Duolun County, improving the quality of the regional ecological environment, realizing the sustainable use of resources, and promoting the coordinated development of the society, the economy and the ecology.

## 1. Overview of the study area

Duolun County is located in the central part of the Inner Mongolia Autonomous Region, the southeastern part of Xilingol League, between latitude 41 ° 46 ' - 42 ° 36 ', longitude 115 ° 51 ' - 116 ° 54 ', adjoining five banners, counties, west of Zhenglan Banner as a neighbor, the north and Chifeng City, Keshiketeng Banner, the east and south of the Weichang Manchu Menggu Autonomous County, respectively, with the three counties of Hebei Province, Fengning Manchu Autonomous County, Guyuan County border. Duolun County is located in the south source of the Hunsandak Sandy Land <sup>[4]</sup>, which belongs to a typical agricultural and pastoral intertwined area <sup>[5]</sup>, and is a key area for the construction of the Beijing-Tianjin Wind and Sand Source Project. The total area of the county is 3863km<sup>2</sup>, with the longest distance from north to south of about 110km, and the longest distance from east to west of about 70km. The county has 3 towns and 2 townships under its jurisdiction, with 65 administrative villages.

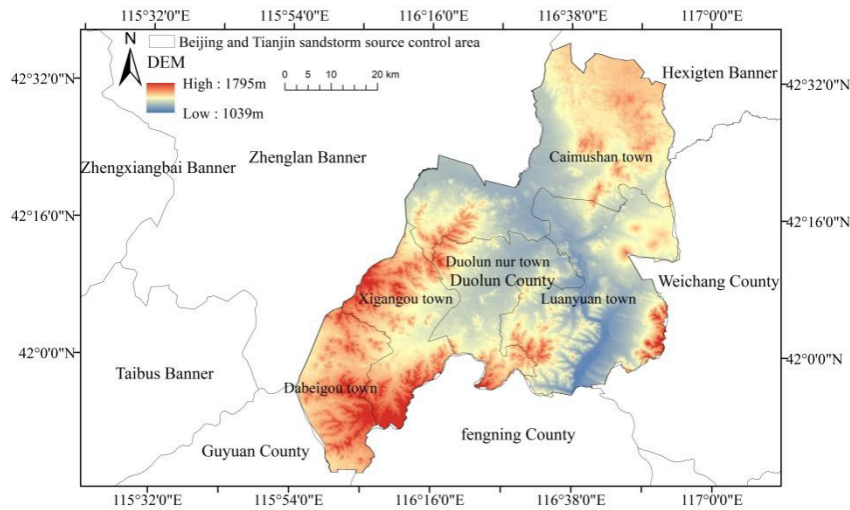

Figure 1 Overview map of the study area

## 2. Research Methodology

### 2.1 Entropy value method

#### Data standardization

Since different indicators have different units and cannot be compared, all indicators need to be quantitatively toughened to eliminate the effects of different quantitative outlines and to make the data comparable. In this study, the extreme value method was selected as the dimensionless processing method for the indexes of the study of resource and environmental carrying capacity of Duolun County, Inner Mongolia, which is characterized by transforming all the values of the indexes within the interval of 0-1, with a minimum of 0 and a maximum of 1. In addition, considering the later data processing, the dimensionless indicator can be shifted by one minimum unit value all the time. In order to meet the arithmetic requirements. The formula of the extreme value method is as follows:

For positive indicators the treatment formula:

$$X_{ij} = \frac{X - X_{\min}}{X_{\max} - X_{\min}}$$

For negative indicators the treatment formula:

$$X_{ij} = \frac{X_{\max} - X}{X_{\max} - X_{\min}}$$

Where:  $m_j$  is the maximum value of  $X_{ij}$  and  $m$  is the minimum value of  $X_{ij}$ .

#### (2) Dimensionless processing

Indicators are categorized into positive and negative indicators, moderate indicators, and interval indicators, depending on their own attributes. Larger values for positive indicators indicate better indicator performance. A smaller value for a negative indicator means that the indicator is performing better. The raw data are dimensionless to eliminate the effect of physical quantities to calculate the characteristic weight or contribution of the  $i$ th administrative village under the  $j$ th indicator.

$$P_{ij} = \frac{X_{ij}}{\sum_{i=1}^n X_{ij}}$$

(3) Calculate the entropy value of the  $j$ th indicator.

$$e_j = -\frac{1}{\ln n} \sum_{i=1}^n p_{ij} \ln(p_{ij}), 0 \leq e_j \leq 1$$

(4) Calculation of the coefficient of variation

$$g_j = 1 - e_j$$

(5) Calculation of evaluation indicator weights  $w_j$

$$w_j = \frac{g_j}{\sum_{i=1}^m g_j}, j = 1, 2, 3, \dots, m$$

## 2.2 Carrying capacity evaluation model

Based on the statistical analysis model for the standardization of data on carrying capacity indicators and their weights, the carrying capacity of administrative villages in Duolun County, Inner Mongolia, was measured using the weighted summation method, with the following formulas.

$$U = \sum_i^n (\sum_j^m X_{ij} \times W_{ij}) \times W_i$$

Where:  $X_{ij}$  is the standardized value of the  $j$ th indicator in the  $i$ th subsystem,  $W_{ij}$  is the weight of the  $j$ th indicator in the  $i$ th subsystem, and  $W_i$  is the weight of the subsystem.  $u$  is the comprehensive carrying capacity of the resources and environment, and the larger value of  $u$  indicates the higher quality.

## 3. Results and analysis

### 3.1 Construction of evaluation index system of resource and environmental carrying capacity

As an open, dynamic and sustainable comprehensive system, the resource and environmental carrying capacity can reflect the coordinated development of human activities in the study area among different influencing factors, and in the process of selecting evaluation indicators and constructing the evaluation indicator system, it is necessary to show scientific rationality and objectivity to ensure the smooth progress of the evaluation and the accuracy of the results. Therefore, the following principles are followed when constructing the resource and environmental carrying capacity evaluation index system.

(1) Principle of science;

The evaluation indicators selected must be scientific, objective and comprehensive to reflect the state of development and evolution of the system under study, and can fully reflect the internal mechanism of resource and environmental carrying capacity, the evaluation of resource and environmental carrying capacity is a scientific and reasonable quantitative analysis combined with the process of qualitative analysis, and the selection of indicators should fully demonstrate the principle of science.

(2) Principle of accessibility;

As a comprehensive evaluation object, the research data of resource and environmental carrying capacity involves many related departments, so the principle of accessibility means that when selecting evaluation indicators, not only the research significance of the indicator should be considered, but also the difficulty of obtaining the indicator.

(3) Systemic principle

The evaluation of resource and environmental carrying capacity of Duolun County is a systematic evaluation, the selection of indicators should systematically reflect the study area "resource supply profile - environmental factors profile - socio-economic profile" of the situation, this paper in the establishment of the indicator system is divided into the resource and environmental carrying capacity of the overall objectives, sub-systems, indicators, layers, layers of advancement, so that sub-systems and the target layer of interaction and integration.

(4) Principle of Integration



Evaluation indicator system as a whole can be comprehensive, objective reflection of the target level, must select a sufficient number of evaluation indicators, in order to comprehensively reflect the degree of interconnectedness of the various factors in the research system, the more systematic information carried by the indicators to reflect the indicator system is more comprehensive.

(5) Principle of dynamism

Resource and environmental carrying capacity is characterized by dynamic changes, which will change with the resource supply profile, ecological profile, topography, and the impact of various human activities and socio-economic profile of the study area.

*3.1.1 Resource and Environmental Carrying Capacity Evaluation Methods and Systems*

(1) Literature analysis method

Literature analysis method is to collect, organize and screen all kinds of literature, the literature through the study, the formation of scientific understanding of the facts of the method. A very effective and economical information collection method, but also the most often used a primitive information processing methods, this paper through the research and collection of related papers, books, journals, web pages, etc., the use of a variety of database tools, a more comprehensive collection of literature on the theory of the carrying capacity of the resources and environment and evaluation of the system of standards and other literature.

(2) Hierarchical analysis

AHP is a practical multi-option or multi-objective decision-making method. This method is suitable for describing problems or decision analysis in which there are many indicators with different criteria, expressing in quantitative form problems that are difficult to study quantitatively. Its biggest feature is the quantification of qualitative problems, the mathematization of thinking judgments, and after hierarchical analysis, it can describe the differences in the degree of importance of each explanatory index, which is conducive to the formation of the final judgment. At present, it is widely used in various fuzzy evaluations.

(3) Comprehensive Evaluation Method

The comprehensive evaluation method is the main research method used in this paper. The comprehensive evaluation method constructs multiple indicators from the whole to evaluate multiple evaluation samples, also known as the multivariate comprehensive evaluation method, and the construction of evaluation indicators is similar to the hierarchical analysis method of evaluation indicator grading. By setting the weights of the indicators, the comprehensive score of each sample is given, and finally the sample scores continue to be ranked, so as to find the optimal sample or the optimal program.

(4) GIS spatial analysis method

Apply GIS technology to geographic information data, spatial data for overlay analysis, spatial query and other analytical processing.

*3.1.2 Methodology for the selection of evaluation indicators*

(1) Expert opinion method

The biggest advantage of the expert opinion method is a good control of the selection of priority screening selection, and has a relatively strong operability, experts generally have a relatively rich experience and party, the use of a number of experts combined with the views can effectively control the selection of indicators, as well as initial purification of the indicators, but this type of method has a strong subjectivity, and the cost of indicator selection is relatively high, the time to control does not have the stability of the use of the process should be flexibly utilized.

(2) Typical indicator screening methods

Complex integrated system in the selection of indicators, usually indicators will be more, but in the specific implementation, the selection of indicators can not be selected comprehensively, this is generally used in the selection of indicators of the cluster analysis, and then select a number of more representative of the significance of the indicators, which is typical of the method of selection of indicators.

(3) Explanatory Structural Modeling

ISM explains the structural type method to analyze, and the ten key influencing factors discover the logical relationship between them to draw the final conclusion. Qualitative analysis can make the article more comprehensive and systematic, of course, quantitative analysis also has its advantages, through the calculation of real data, the conclusion is more convincing.

### 3.1.3 Selection of evaluation indicators

Resource and environmental carrying capacity is the result of the interaction between the resource supply profile, environmental profile, socio-economic profile and human activities, and fully reflects the capacity of the study area to carry the population and the corresponding socio-economic total. The construction of Duolun County resource and environmental carrying capacity evaluation index system should start from the actual profile of Duolun County, as far as possible, the impact factors affecting the resource and environmental carrying capacity will be taken into account, taking into account the profile of Duolun County as a whole as well as the administrative villages. By referring to the relevant results of the study of resource and environmental carrying capacity, following the above basis for the selection of indicators and the principles of indicator system construction, and combining the actual situation of Duolun County and the difficulty of obtaining data, we constructed the evaluation index system of resource and environmental carrying capacity of Duolun County, which contains resource subsystem, environmental subsystem, and socio-economic subsystem, with a total of 20 indexes.

## 3.2 Characterization of spatial and temporal changes in the carrying capacity of resources and environment

The spatial distribution of the resource and environmental carrying capacity of Dorian County from 2005 to 2020 is all characterized by the northeast being higher than the southwest area. In 2005, the high carrying capacity areas were located in the central region of the County, in the Village of North, and in the northern region, in the Village of Green Dragon's Back, and accounted for 11 percent of the total land area. The higher carrying capacity areas are located in the southern, central and northern parts of the county, accounting for 22% of the total land area. The Central Carrying Capacity Area is located in the central, southwestern, and northern portions of the County. It accounts for 40% of the total land area. The lower carrying capacity and lower carrying capacity are distributed in the central, northern, and southern parts of the county, showing spatial aggregation and distribution, and accounting for 28% of the total land area. 2005-2010, the high carrying capacity areas showed no significant change in space, and the higher carrying capacity areas were spatially dispersed in the eastern and central parts of the county by 2010, showing aggregation and distribution, accounting for 21% of the total land area. The 2010 Medium Carrying Capacity Area is clustered in the central and eastern portions of the county, accounting for 41 percent of the total land area. The lower carrying capacity areas are mostly clustered in the southern and southwestern portions of the county, with a few scattered in the northern and central portions of the county, accounting for 25 percent of the total land area. The smaller low carrying capacity areas account for only a fraction of the total land area. The Medium Carrying Capacity Area is found in the southwestern region and central part of the County, accounting for 16 percent of the total land area. The lower carrying capacity areas are in the southwestern region of the County and are dispersed in the southern and eastern regions, comprising 19 percent of the total land area. The low carrying capacity areas are located in the southwestern portion of the County and comprise 6% of the total land area. The high carrying capacity areas in 2020 are located in the northern portion of the County and the central portion of the County and comprise 12% of the total land area. The higher carrying capacity areas are dispersed in the northern portion of the County and the southern and eastern portions of the County comprise 30% of the total land area. The high carrying capacity areas are located in the northern portion of the County and in the eastern portion of the County. The Medium Carrying Capacity Area is located in the southern, southwestern, eastern, and central portions of the County and comprises 33% of the total land area. The lower carrying capacity areas are located in the central, southwestern, and northern portions of the County and comprise 22% of the total land area. The Low Carrying Capacity Area is located in the southern portion of the County and comprises only 3% of the total land area.

The comprehensive carrying capacity of resources and environment from 2005 to 2020 shows the spatial characteristics that villages in the northeastern region are higher than those in the southwestern region, and villages with high carrying capacity values are mainly distributed in the northeastern region of Duolun County, with a small number of villages distributed in the central region of Duolun County. Villages with low carrying capacity values are mainly distributed in the southwestern part of Duolun County and villages in the central part of the county.



Figure 2 Spatial and temporal distribution of resource and environmental carrying capacity of Duolun County, Inner Mongolia, 2005-2020

## 4. Conclusion and outlook

### 4.1 Conclusion

Taking the typical ecologically fragile area of Duolun County in Inner Mongolia as the study area, and the administrative village domain as the evaluation unit, using digital elevation data, remote sensing image data, meteorological data, land use data, soil data, and socio-economic statistical data to fully consider the land resources, climatic resources, location resources, ecological and environmental factors, topographical and geomorphological factors, and socio-economic influences, to construct the indicator system of the resource and environmental carrying capacity based on the carrying capacity of the resource sub-systems, the carrying capacity of the environment sub-systems, and the carrying capacity of the socio-economic sub-systems with three dimensions, and to analyze the temporal and spatial characteristics of the resource and environmental carrying capacity in the period from 2005 to 2020.

The comprehensive carrying capacity of resources and environment from 2005 to 2020 shows the spatial characteristics that villages in the northeastern region are higher than those in the southwestern region, and villages with high carrying capacity values are mainly distributed in the northeastern region of Duolun County, with a small number of villages distributed in the central region of Duolun County. Villages with low carrying capacity values are mainly distributed in the southwestern part of Duolun County and villages in the central part of the county. The center of gravity of the high carrying capacity in the comprehensive carrying capacity of resources and environment shows the migration characteristics of southwest-northeast pattern. The higher carrying capacity shows the migration characteristics of the center of gravity in the southeast-northwest-northeast pattern. The center of gravity of medium carrying capacity shows the migration characteristics of northeast-southwest-southeast pattern. Lower carrying capacity presents migration characteristics of the center of gravity in a southwest-northeast-southwest pattern. The low carrying capacity center of gravity exhibits migration characteristics in a northeast-southwest pattern.

### 4.2 Outlook

Due to the construction of the evaluation index system and the selection of indicators in this paper, the lack of relevant data and the slight difficulty in obtaining some of the indicators lead to the evaluation index system is not comprehensive enough. As a result, the evaluation results of the resource and environmental carrying capacity of this paper are subjective, and the analysis of the results is a little shallow. Therefore, the depth of research on the resource and environmental carrying capacity of the study area needs to be further improved. It is hoped that in the future, we can collect data from various sources, conduct more field surveys, fully understand the resources, environment

and socio-economic status of the study area, and establish a more complete and comprehensive evaluation index system. Although this paper adopts the entropy value method, comprehensive index model, and research on the existing level and historical changes of the resource and environmental carrying capacity of Duolun County, the future development trend of the resource and environmental carrying capacity of Duolun County in Inner Mongolia is not predicted, and it is hoped that effective research methods can be considered in future research to predict and analyze the resource and environmental carrying capacity of Duolun County in Inner Mongolia.

## References

- [1] Keyu B ,Gang H ,Jun R , et al.Analysis on the resource and environmental carrying capacity of coal city based on improved system dynamics model: a case study of Huainan, China.[J].Environmental science and pollution research international,2022,30(13):36728-36743.
- [2] Chong W ,Anding J ,Wenlong Z .Study on the Measures for Optimizing China's Provincial Territorial Space Based on the Perspective of Resource and Environmental Carrying Capacity in the New Situation[J].Sustainability,2022,14(21):13754-13754.
- [3] DongSheng Z ,XueMei Z ,SiQi D , et al.[Evaluation theory and method of regional resources and environmental carrying capacity.] [J].Ying yong sheng tai xue bao = The journal of applied ecology,2022,33(3):591-602.
- [4] Wang Hao, Yao Fei, Zhu Hua sheng, et al. Spatiotemporal Variation of Vegetation Coverage and Its Response to Climate Factors and Human Activities in Arid and Semi-Arid Areas: Case Study of the Otindag Sandy Land in China[J].Sustainability, 2020,12(12):5214.
- [5] Wu Renji, Tang Haiping, Lu Yunjing. Exploring subjective well-being and ecosystem services perception in the agro-pastoral ecotone of northern China[J]. Journal of Environmental Management, 2022, 318:115591.

# Teaching reform and exploration of Game Programming Design to cultivate Computational thinking

Hao Liu

Nanning College of Technology, Guilin 541006, China.

---

**Abstract:** Computational thinking can effectively reflect the essential characteristics and core methods of computer science, so in the process of teaching work, relevant educators should pay attention to the effective cultivation of students' computational thinking. This training work not only meets the actual requirements of the current national society for computer science and technology discipline, but also has a very important practical significance for promoting the development of students' core literacy of computer discipline. Below, therefore, will be the first in-depth analysis of computational thinking training, clear the education teaching may encounter problems in the process, and then from the perspective of the game programming, put forward the basic scheme of teaching reform, finally clear computing thinking training the game programming the development of teaching reform strategy, aims to promote the further improvement of education teaching quality, help students realize the all-round development of comprehensive quality.

**Keywords:** Computational thinking training; Game programming; Teaching reform plan; Subsequent development strategy and in-depth exploration

---

## Introduction

In the context of the information age, computational thinking has become a literacy that contemporary young people must have. Therefore, this literacy has been widely concerned by many universities and research institutions at home and abroad, making the cultivation of computational thinking become one of the important contents of computer teaching. In this environment, in order to realize the effective cultivation of students' computational thinking, China Engineering Education Certification Association put forward the quality standards of engineering education professional certification, the core concept of the relevant requirements is: ① clear the main position of students in the teaching work. ② Take the teaching results as the basic guidance. ③ In the process of teaching work, actively promote the reform and development of the subject. With the support of the three basic teaching concepts, the teaching quality of computer science will be further improved to ensure that the talents of this major in relevant universities can be fully trained. The following will explore the development of computer courses and the cultivation of computational thinking from the perspective of Game Programming Design.

## 1. Computational thinking cultivation and analysis

Computational thinking is embodied in the program design and realization ability, abstract thinking ability, logical thinking ability and algorithm design and analysis ability. However, through the understanding of the training of computational thinking in relevant colleges and universities, it can be found that in the process of teaching work, teachers and students will pay too much attention to the cultivation of a certain ability, resulting in the neglect of the overall computational thinking training to a certain extent. In addition, in the process of teaching work, the communication level between teachers and students is relatively low, which makes it impossible for teaching to have a comprehensive understanding of the actual learning needs of students, thus leading to the relatively general actual training effect. In addition, in terms of teaching resources, because relevant teaching resources have not been fully integrated, the process of subsequent teaching work leads to the lack of actual curriculum support, which cannot achieve the segmentation of highly complex knowledge points, resulting to the decline of teaching effectiveness. In addition, the calculation thinking training work can be found in the process of the teaching evaluation system of the work perfect degree is relatively insufficient, cause students and teachers cannot reflect the problems of the teaching work, cannot promote the subsequent teaching quality, is not conducive to the sustainable development of computer discipline.

In the process of cultivating students computational thinking, related education workers should be adhering to the systematic teaching ideas, in view of today's social actual demand for high-end computer talent, in the process of training students computing thinking, should

strengthen the teaching material theory knowledge teaching, good computer basis for students, to improve the computational thinking training efficiency has important practical significance<sup>[1]</sup>. Second, in the process of teaching work, teachers should actively organize practice teaching activities, strengthen the attention of the practice link, makes the specific teaching process, the relevant teaching content, teaching link can be effectively optimized, and realize the comprehensive cultivation of computational thinking to the students, makes the students can have good ability to analyze problems, ability to solve problems and the ability to design complex system. In the process of computational thinking training, the specific teaching objectives should be as follows: ① Help students understand the solution methods of abstract level problems, so that students can have good abstract thinking ability, and master the corresponding logical thinking methods. ② Master the solution technology of language-level problems, clarify the logical structure and storage structure of related problems, effectively master the basic computability theory, clarify the analysis method of complex algorithm problems, and fully master the basic idea of program design. ③ Master the solution method of computer system-level problems, and further improve their own system software design and implementation ability.

## **2. Teaching reform plan of Game programming to cultivate computational thinking**

### **2.1 Based on the grammar**

Because grammar is the basis of the whole computer discipline, so in the process of computational thinking training teaching reform design should be grammar as the basis of the whole teaching reform, through active grammar teaching work, makes the students can have a full grasp of basic teaching content, for the cultivation of students' subsequent computational thinking to lay a solid foundation. In addition, after taking grammar as the basic teaching content, the classroom teaching resources will also become more abundant, which can provide sufficient opportunities for students to exercise their basic computer skills<sup>[2]</sup>. Therefore, in the process of carrying out their work, the relevant educators should pay more attention to the basic grammar teaching, so as to promote the high-quality and efficient development of the follow-up teaching work.

### **2.2 Take the example analysis as the content**

In the process of teaching work, it is necessary to strengthen the attention to practical teaching and promote the coordinated development of students' computational thinking and computer skills through practical practice. In the process of applying the example analysis model to carry out the teaching work, the relevant staff can design the teaching content through the top-down way of the examples. Because the game programming of the course teaching goal to let students have the ability of game programming, so in the process of choosing teaching examples, the teacher should choose three teaching case in stages to cultivate students' computing thinking, and in the process of choosing teaching examples, the relevant staff shall ensure the corresponding instance effectively match the visual dimensions of the game. In the process of the actual teaching work, teachers should first show the completed teaching examples and demonstration procedures to ensure that students have a basic understanding of the corresponding examples. Secondly, teachers explain the teaching content according to the course order in the teaching materials, so that students can understand the professional knowledge of computer science from the shallow to the deep. After the completion of the explanation work, in order to effectively consolidate students' professional knowledge, teachers should reasonably arrange homework after class content in the process of carrying out teaching work, so that students can complete certain program projects alone or cooperatively. Through this "theory-practical case-practical programming operation" way to carry out the teaching work, so that students' various computer literacy can be effectively cultivated, and in this process, students' computational thinking ability level will also be subtly improved<sup>[3]</sup>. Carrying out teaching work through this teaching mode can not only realize the high-quality and efficient development of teaching work, but also effectively cultivate students' computing thinking. In this process, students will not feel great teaching pressure, which also has important practical significance for promoting the healthy development of students.

### **3. The development strategy of the teaching reform of game programming to cultivate computational thinking**

#### **3.1 Interactive innovation between teachers and students**

In the process of teaching work, in order to further improve the effectiveness of teaching, teachers and students should maintain a high level of interaction and communication. Through interactive communication, teachers can have a full understanding of students' actual learning needs, and then optimize and improve the follow-up teaching plan to ensure that students' learning needs can be fully met. Since the actual educational value of game programming lies in exercising and improving students' computational thinking ability, students should not just use the teacher's thinking way to solve related problems in the teaching process. In the process of teaching work, teachers should help students develop a good sense of innovation through communication, and exercise students' innovation ability through reasonable teaching cases, so that students can solve practical problems through their own way, which plays an important role in enhancing students' learning enthusiasm.

#### **3.2 Teaching reflection and evaluation**

After complete the teaching work, teachers and students should actively carry out reflection and evaluation work, teaching and students can clear their deficiencies in the classroom, and help teachers optimize teaching plan, help students change learning attitude, further enhance the teaching level of teachers and students and interactive effect, realize the game program design of high quality and efficient teaching work.

### **Conclusion**

To sum up, the effective cultivation of computational thinking can promote the comprehensive development of students' comprehensive quality. Therefore, teachers should pay attention to the cultivation of students' thinking ability in the process of carrying out the work of "Game Programming Design", and adopt multiple means to promote the improvement of teaching effectiveness, so as to promote students' all-round development.

### **References**

- [1] Zhang Biao.— Take the course of "Python language programming" as an example [J]. China Information Technology Education, 2022 (14): 110-112.
- [2] Han Wanjiang, Yang Jincui, Sun Pengfei, Gao Hui, Jin Xin. Discussion on the teaching mode of computational thinking based on "production, research and thinking" [J]. Software Guide, 2022,21 (07): 79-82.
- [3] Yang Jinying, Chen Shui'e. Using the "incremental growth" project to cultivate students' computational thinking —— "Foundation of program design" large unit project teaching analysis [J]. Information Technology Education in China, 2022 (13): 25-27 + 30-30.
- [4] Zheng Caixia, Ge Yingying, Shi Yan-jiao, Zhang Jie, Kong Jun. Design of PBL teaching mode for the cultivation of computational thinking —— Take the pattern recognition course as an example [J]. Software Guide, 2022,21 (06): 225-229.
- [5] Zhou Chun.— Based on the survey of 8981 sixth grade students in M District of Shanghai [J]. The Shanghai Education and Scientific Research, 2022(06):42-47.DOI:10.16194/j.cnki.31-1059/g4.2022.06.005.

Foundation Items: Guangxi Higher Education undergraduate Teaching Reform Project(2021JGA412, Research and Practice of Gamification Teaching Based on Computational Thinking Training in C Programming Language)

# The Enlightenment of Western Education Leadership Theory to Higher Education Management in China

Shanghong Sun

Lyceum of the Philippines University-Batangas, Capitol Site Batangas City 4200, Philippines, Hetao College, Bayannur 015000, China.

---

**Abstract:** With the rapid development of the global economy, education around the world continues to move forward, and higher education has also developed rapidly. Western countries have a certain role in guiding China's management system in education. This paper mainly discusses some problems in Chinese colleges and universities, and puts forward solutions to promote the development of better and faster in Chinese colleges and universities in the future, at the same time through the influence of western education leadership on Chinese talent training mode, to analyze the experience and lessons to suit the national conditions, provide reference for higher education.

**Keywords:** Western education leadership theory of Chinese higher education management

---

Introduction: With the development of society and the continuous improvement of people's requirements for education, higher education has also made great progress in the continuous exploration. At present, the scale of colleges and universities in China is expanding, and the teaching quality is improving year by year. However, due to the traditional factors such as Chinese institutions and universities have long formed as the academic status of inertial thinking mode and single, elitist phenomenon, at the same time some teachers lack of innovation and creativity, lead to students' learning efficiency and talent training effect and so on problems gradually exposed, and restrict the modernization of higher education management education development speed up, and affect the overall quality of colleges and universities.

## 1. Overview of western educational leadership theory

The study of western educational theory, represented by the United States, mainly conducts in-depth discussion and exploration of educational reform. From the 1850s to the late 1870s. With economic globalization, information revolution and the rapid development and progress of science and technology and the talent flow between the world under the influence of some new ideas, new ideas and innovative ideas, higher education reform is gradually formed and gradually improve its basic theoretical system, emphasis on the student, attach importance to the interaction between teachers and students in the process of education teaching method, pay attention to cultivate students' independent learning ability and comprehensive quality. The main content of western educational theory is people-centered. Homans, a famous American educator, proposed that all the activities of the school are completed by students and teachers together. Therefore, in the teaching process to respect children, attention and creative thinking ability to mobilize students learning initiative and potential, but also pay attention to the interaction between teachers and students and mutual understanding, thus influence the knowledge and skills, and establish the corresponding education means to ensure its smooth.

## 2. Feasibility of western educational leadership theory

The combination of the study of western educational theory and the practice of higher education in China promotes the improvement of the educational level and management ability of Chinese universities to a certain extent. From the United States, Japan and other developed countries to take its essence to discard its dross, learn from each other to develop our own outstanding talents. In terms of curriculum, western educational concept emphasizes people-oriented thought, pays attention to the principle of individual differences, pays attention to the cultivation and development of human behavior factors in the learning process and the teaching evaluation system, so that every student can grow and progress on the road he is good at. Compared with the actual situation of Chinese colleges and universities, the western educational theory system has strong adaptability and application. Teaching methods and means, our country higher education in practice constantly explore new ideas, western education leadership theory also began into our country talent training process, and gradually formed suitable for our national conditions and conform to the law of students' physical and mental health growth education mode and system, there are many schol-



ars in Chinese university education management system put forward their original ideas and countermeasures. Western educational theories and methods have certain practical feasibility. There is a close relationship between Chinese schools, society and government. Therefore, to realize their own development goals, Chinese universities must constantly absorb advanced ideas and scientific management mode to enrich their knowledge structure, learn from abroad and apply them to promote the vigorous development of higher education and the improvement of education quality.

### **3. Limitations of western Education Leadership theory to the management of Higher education in China**

Western education leadership theory has certain reference significance for the management of Chinese higher education, but due to China's national conditions, history and other reasons, it is not completely copy the experience of individualism. For example, the first point is that there is still a gap between teaching methods compared with domestic universities, and the second point is that western countries pay more attention to practical and operational skills and ignore the problems and solutions occurring in the learning process. The third aspect is greatly influenced by the traditional education system. China's education mode is not teacher-centered, the lack of innovation consciousness and other factors restrict the choice of the development direction of higher education. The development of education cannot be separated from people, and the same is true of modern higher education. As a social main body, education plays an important role in the development of the whole country and the nation. However, western developed countries have great attraction to talent training due to their high economic level and developed science and technology. So for our country to realize the modernization of education will attach importance to its management concept and method innovation, but also to establish scientific and reasonable incentive system to stimulate the enthusiasm of employees and creative spirit, provide power support for higher education career, promote modern college students employment entrepreneurship and social stability development laid the foundation and promote the reform of higher education forward.

### **4. The Enlightenment of the Western Education Leadership Theory to the Management of Higher Education in China**

#### **4.1 Combine curriculum setting and teaching reform**

Curriculum setting should be combined with teaching reform. Under the traditional education mode, the development of higher education in China is mainly based on knowledge transmission, while western countries pay attention to the cultivation of practice and innovation ability. Therefore, students in Chinese universities are more theoretical learning talents. In terms of curriculum setting, Chinese education mainly takes professional knowledge and skills as the main core part. And schools in western countries is more by opening some cross, systematic strong public compulsory courses to promote students' comprehensive use of theory and practical problem solving ability, which is more prominent in colleges and universities and distinctive talent training mode, but at the same time due to the education system development is not perfect and there are many deficiencies, curriculum mainly subject professional knowledge and skills as the main content.

#### **4.2 Establish correct and advanced management concepts**

In western countries, the management of higher education mainly includes: personnel training, curriculum setting and teaching methods. We will establish a scientific and sound education system. Chinese colleges and universities to develop from the reality of time development goals and education concept system and adjust the structure according to their own situation, at the same time to strengthen the strength of school internal faculty construction and teacher quality improvement, and constantly introduce foreign advanced experience and theoretical guiding ideology to promote China's higher education career forward better and faster. The modernization of education is people-oriented. People in school not only impart knowledge, but also learn to learn. Therefore, as a modern western higher education management talent must set up the correct advanced concept. The key to sustainability lies in the socialist system of running schools with Chinese characteristics. So under the new situation, we should strengthen the western advanced experience and learning and improve the innovation, promote our talent training mode towards the world-class university, but also through a variety of ways to broaden the channels of talent exchanges

and cooperation between Chinese and foreign universities to enhance various aspects of education information resources communication, mutual trust and cooperation, etc. The increasingly fierce and complicated competition among countries in the world, as well as the continuous development and improvement of network technology, all require us to change the traditional and backward ideas, thinking mode and behavior mode to meet the needs of rapid economic and social changes.

### **4.3 Strengthen the construction of the teaching staff**

In the development of higher education in western countries, targeted reform should be carried out in the construction of teaching staff. In terms of internal personnel allocation, the university pays attention to professional training and further training at on-the-job graduate level, attaches great importance to the introduction of outstanding students such as young backbone teachers and leading cadres and the retention of outstanding graduates, so as to provide sufficient reserve force for the construction of teachers. Therefore, we should strengthen the construction of teachers. Each school should establish a high quality, high quality of professional high level college students teachers, then should pay attention to the introduction of young outstanding graduates to the existing school teaching or teaching tasks, again to improve on-the-job graduate tutor treatment and perfect title promotion system to ensure the healthy development of higher education in our country, realize the “double” outstanding talent training goal, so to strengthen the communication between colleges and universities and employers, curriculum, etc. By establishing and improving the internal human resources management system to improve the employment rate of graduates, strengthen the training of existing teachers, encourage outstanding students to exercise in social practice and actively participate in academic conferences and discipline competitions to enhance the professional quality of teachers.

## **5. Summary**

This paper analyzes the enlightenment of western education leadership theory and the management of higher education in China, and puts forward several suggestions for the current face and future development direction of Chinese universities, which provides reference for better promoting the development of Chinese universities and improving the quality of running schools. Reform from the curriculum setting, teaching methods and other aspects. The curriculum should be constantly adjusted continuously according to the social and economic environment and its own needs. At the same time, strengthen the construction of teachers and improve the professional quality of teachers to achieve the goal of education and training of talents, the school internal personnel allocation to strengthen the training of academic education management personnel to stimulate students' interest and enthusiasm in learning.

## **References**

- [1] Fu Guoguang, Li Xiangyao.— takes the theory of cultural leadership and shared leadership theory as an example [J].Teacher, 2011, (11): 30-31.
- [2] Xiao Minhui, Huang Wei.The Progress of Western Educational Leadership Theory and Its Enlightenment to China [J].Journal of Jiangxi Normal University (Philosophy and Social Sciences edition), 2016,49 (5): 105-109.

# Exploration on the construction of teaching Leadership in the Era of Big Data

Yong Yang<sup>1,2</sup>

1. Lyceum of the Philippines University Graduate School, Philippines, Batangas, 4200

2. Department of Mechanical and Electrical Engineering Hetao college, Bayannur 015000, China.

---

**Abstract:** The era of big data has provided unprecedented educational opportunities. In recent years, with the deepening of education reform, the higher education model has changed fundamentally. Therefore, it is necessary to further improve the teaching leadership of teachers and cultivate qualified talents. This paper discusses the necessity of improving the teaching leadership in the background of big data, and discusses the effective measures to improve the teaching leadership in the era of big data.

**Keywords:** Big data; University teachers; Teaching leadership

---

Big data puts forward higher requirements for the teaching leadership of college teachers, which enables teachers to break the shackles of the traditional education system, guide students to learn professional knowledge, expand professional thinking, especially cultivate practical students in the professional field in the future. Only in this way can teachers make better use of their knowledge and experience, serve the society and realize their life value. At present, teachers' teaching leadership is not strong, their work efficiency is low, and there are serious problems in talent development. Therefore, it is very important to make full use of the advantages of big data to strengthen the teaching leadership of university teachers.

## 1. Necessity to improve the teaching leadership of college teachers under the background of big data

### 1.1 It is conducive to tapping students' professional potential

At present, although colleges and universities are constantly sending talents to the society, the quality of talents cannot be guaranteed. Students' professional interests and learning abilities vary differently. When some high school students fill in the application volunteer, in order to be successfully admitted to the university, fill in the major that they do not particularly understand, which will lead to the decline of the teaching quality of colleges and universities. And some funny things can provide opportunities to change majors, so that students can strengthen professional guidance in the learning process, can fully understand the potential of students, develop students' knowledge, analyze and solve professional problems. Combine theory with practice, and improve students' practical ability. Students with learning background do not get enough attention in colleges and universities, and under the influence of various factors, students cannot concentrate on learning professional content. Most students only understand the basics and do not go deep into the learning content. This can neither promote the development of professional skills nor increase student employment rates. According to the development of The Times, students' interest in professional data can be used to improve the role of teachers in professional choice.<sup>[1]</sup>

## 2. Principles of classroom leadership improvement for college teachers

First, give the students the space. Leadership does not mean supervision and restriction. Teachers have a direct and binding responsibility for students. At the same time, teachers combine basic professional ability, intellectual and emotional, teacher authoritative learning process and many other factors. Teaching process does not equal to the teacher's control of the learning process, but the mandatory control of students. The concept of university teachers' leadership emphasizes the comprehensive influence on the teacher-student interaction, rather than the guiding power for teachers. College students are in a special age group, and their physical and mental development is immature. Colleges and universities must change from one-way management to the joint training between teachers and students through leadership. Senior teachers must change their ideas and provide students with space for themselves<sup>[2]</sup>.

Second, to ability training. No longer unilaterally instilling knowledge in students, the mastery of practical function knowledge is directly related to students' understanding, digestion and development ability, and is related to students' future career planning and life. Teachers teach in the classroom, so we must shift from the traditional knowledge-based teaching methods to the development of important skills. In order to ensure the normal and effective operation of the classroom, monitor all the teaching links in the classroom, change the classroom teaching mode, and follow the student-centered teaching concept.

Third, innovation and expansion. Colleges and universities must adhere to student-centered teaching, and teachers must give students opportunities to think and solve problems in the process of work. Reasonable and standardized classroom can guide students to actively think and solve problems, improve students' independent research ability and collective cooperation ability, not only improve students' ability to apply knowledge, but also improve students' comprehensive quality.

### **3. The influencing factors of college teachers' teaching leadership**

#### **3.1 The Influence of university cultural atmosphere**

School culture plays an important role in the development of teachers and affects the efficiency of teachers' teaching leadership to a large extent. However, the difficult scientific research atmosphere and the loose teaching process of the school largely hinder the teaching activities of the school. The lack of teachers' enthusiasm leads to teachers' reluctance to invest in teaching and low enthusiasm, which affects the formation and development of teachers' teaching leadership. In addition, the cultural tradition of colleges and universities hinders the formation and implementation of teaching policies to some extent. The estrangement between school members partly limits the willingness of university teachers to share professional teaching knowledge with their colleagues. Generally speaking, teachers do not interfere with each other in the learning process. Therefore, many teachers are not willing to assume the responsibility of leading teachers and fear of destroying the harmonious relationship. In the long run, the motivation of teachers to cooperate and communicate with others will be weakened<sup>[3]</sup>.

#### **3.2 The Influence of teachers' personal concepts and characteristics**

Teaching concept directly affects the teaching orientation, and teachers' attitude towards students determines the way of teachers' work. The work of teachers is to promote students' all-round development, fully consider the needs of students, stimulate students' internal motivation, and maintain a good relationship with students in the learning process.

## **4. Effective Measures to Improve the Teaching Leadership of College teachers in the Era of Big Data**

#### **4.1 Encourage college teachers to participate in the research work**

Colleges and universities should encourage teachers to actively participate in relevant research and attach great importance to teachers' teaching leadership. In the rapidly developing information society, teachers must constantly update and enrich their knowledge and abilities in order to better serve the students. Colleges and universities need to improve the education system, emphasizing that teachers should not only cultivate teaching skills, but also improve their leadership position, gradually improve the quantitative evaluation standards, and stimulate their enthusiasm.<sup>[4]</sup>

#### **4.2 Give full play to the advantages of big data to improve teachers' teaching ability**

At present, some teachers face many challenges in the use of professional information technology, which is not conducive to the improvement of teaching quality. Therefore, teachers must reevaluate the data and play an important role. First, teachers must improve their skills, change the traditional educational thinking, and take measures to realize the importance of big data in the process of teacher training. Teachers should actively use big data as a useful teaching tool. In the process of practical learning, we must strengthen the control of teaching, so as to fully mobilize classroom activities and control all students' activities in the learning stage. Avoid some students can not keep up with the pace of the teacher, affect the teaching effect. In addition, teachers must improve their understanding of big data, analyze the charac-

teristics of big data, use big data to analyze the characteristics of teaching, and use the advantages of big data to help teachers improve their leadership<sup>[5]</sup>.

### 4.3 Try to practice the teaching leadership

It is an effective way to improve the management level of college teachers. In classroom teaching, establishing a common learning culture is one of the important means to improve the leadership of college teachers in teaching. Therefore, teachers can improve teaching leadership by building a common learning culture in the classroom. In the process of learning, we should pay attention to the value orientation of mutual cooperation, mutual care and resource sharing, guide and encourage students, respect students' basic positions, and pay attention to their individual differences. Teachers guide the students in the classroom, in the atmosphere of mutual understanding, in the spirit of cooperation, to achieve common goals, common guidance, and in this process to improve their skills. In addition, college teachers should actively participate in the formation of an education community, strengthen cooperation with other teachers, actively participate in higher education reform, give full play to their leadership role and improve leadership.

Tag

In the era of big data, college teachers are facing great challenges and development opportunities. Teachers must actively understand their leadership role. Only in this way can they fully fulfill their mission and responsibilities. In recent years, the deepening of educational reform has fundamentally changed the education mode of colleges and universities, further improved the leadership of teachers, and cultivated qualified talents. Strengthening the leadership of teachers is of great significance to promote students' learning, improve professional skills, and better adapt to the needs of social development.

## References

- [1] Yunjuan Yang. Teaching Leadership Construction of College Teachers in the Era of Big Data in Education [J]. Charm China, 2020 (35): 361-362.
- [2] Hong Chengwen, Li Yang. Teaching Leadership Construction of College Teachers in the Era of Big Data in Education [J]. Wenyuan (high school edition), 2021 (3): 1525.
- [3] Yang Mengping, Chen Yijun. Comparative Study on Teaching Leadership [J]. Heilongjiang Higher Education Research, 2020, 38 (8): 39-43.
- [4] Rao Aijing, Wan Kun, Zou Wei. Teaching Leadership Construction of College Teachers in the Era of Big Data in Education [J]. Modern Education Management, 2019 (1): 57-61.
- [5] Zhang Mingming. Research on Teaching Leadership Improvement Strategies of College Teachers [D]. Heilongjiang: Harbin Normal University, 2016.

# Strategic Research on International Communication of Chinese Traditional Sports Culture under the Background of “the Belt and Road”

Sijia Jiang

Chongqing University of Posts and Telecommunications, Chongqing 400000, China.

---

**Abstract:** With the extensive promotion of the “Belt and Road” initiative, the cooperation between China and countries along the route in the fields of economy, politics, and culture has been deepening. In terms of cultural exchange, traditional ethnic sports culture serves as an important carrier to promote mutual understanding and cultural exchange, and has unique value in enhancing the international influence of Chinese culture and shaping the national image. However, in the actual process of international communication, our traditional ethnic sports culture still faces a series of challenges, including insufficient understanding of it abroad, lack of effective international promotion strategies, incomplete construction of international cooperation platforms, and weak international influence. This study aims to explore the dissemination strategies of traditional ethnic sports culture in China in the context of the “Belt and Road” initiative, in order to provide reference for its international communication and promotion. Through research methods such as literature review and expert interviews, this study analyzes the challenges and opportunities faced by the international communication of traditional ethnic sports culture in China, and based on this, proposes specific strategies.

**Keywords:** One Belt One Road; Traditional ethnic sports culture; International exchanges; Promotion strategies; Cultural identity

---

The “Belt and Road” Initiative is an important strategic concept proposed by the Chinese government based on the idea of a community with a shared future for humanity, aiming to promote international economic development and cooperation. The initiative received global support from world leaders in April 2019 and emphasizes that the opportunities and outcomes of co-building belong to the world. The key areas of the “Belt and Road” construction are policy coordination, connectivity of facilities, unimpeded trade, financial integration, and people-to-people bonds. The proposal of these five aspects demonstrates that this strategic concept aims not only to achieve political and economic connectivity but also to promote cultural exchange to facilitate mutual understanding and resolve cultural differences and conflicts (Xi Jinping, 2017). In this context, traditional ethnic sports and culture, as an important part of Chinese traditional culture, play a unique role in spreading positive energy and promoting the dreams of building a strong sports nation and national rejuvenation. Therefore, how to promote traditional ethnic sports and culture and utilize its unique role to achieve the goals of a strong sports nation and national rejuvenation becomes a problem that needs to be studied and addressed. Different scholars have different interpretations of traditional ethnic sports and culture. Zhu Jianguo believes that traditional ethnic sports and culture refer to the overall development level, extent, and quality of all forms of sports activities, sports spirit, and sports systems created and preserved by a nation in its social sports practices (Zhu Jianguo, 2005). Scholars such as Duan Aiming and Bai Jinxiang argue that traditional ethnic sports and culture of the Chinese nation refer to the overall sum of the categories, rules, systems, and facilities that have been created and passed down through the generations of various ethnic groups in China and are used to enhance the biological and spiritual potential of human beings (Duan Aiming, Bai Jinxiang, 2005). Scholars Xue Hongbo and Cheng Wenguang provide their understanding, stating that the international exchange of traditional ethnic sports and culture in our country needs to simultaneously focus on material culture, institutional culture, and spiritual culture. Material culture refers to the projects and facilities that serve as carriers of culture, while institutional culture refers to the rules and norms in the implementation of cultural practices. Spiritual culture, on the other hand, is an important component in establishing an international discourse system for culture. These three aspects together constitute the internal logic of international exchanges in traditional ethnic sports culture in China (Xue Hongbo, Cheng Wenguang, 2019).

## **1. The Relationship between the “Belt and Road” Initiative and the Traditional Ethnic Sports Culture in China**

The introduction of the “Belt and Road” initiative and the positive response from neighboring countries have provided a good communication platform for the integration and development of cultural diversity along the route. As a newly emerged phenomenon, ethnic traditional sports are an important part of national development, and in the current era of globalization, they face a daunting task (Li Yingying, Liu Ni, 2017). The implementation of the “Belt and Road” initiative has created a favorable platform for international exchange and cooperation in ethnic traditional sports culture, enabling the interaction and integration of various cultures through the carrier of ethnic traditional sports. At the same time, the development of cultural diversity along the “Belt and Road” has created a favorable atmosphere for international exchange in ethnic traditional sports culture, while the increasingly close economic, trade, and tourism exchanges have laid a solid foundation for the development of ethnic traditional sports culture. It provides valuable experience for the practice of excellent ethnic traditional sports culture .

## **2. Problems in the exchange of traditional ethnic sports and cultural under the background of “Belt and Road Initiative”**

The digital divide is highlighted, and there is a shortage of international communication platforms. With the advent of the information age, although China’s traditional sports culture will be transmitted to the world through digital means, compared to Western countries, there are issues of “information disparity” or “information poverty gap” in China’s information technology field. The emergence of digital media has rendered the traditional oral and practical exchange of Chinese traditional sports culture unable to meet the current cultural demands. The low level of digital technology, low utilization rate, and shortage of digital communication platforms have influenced the international development of Chinese traditional sports culture. At the same time, the rapid promotion of Western sports culture will further increase the digital divide in the exchange of Chinese traditional sports culture.

Misunderstandings about China’s traditional ethnic sports culture arise from individuals or groups with different international geographical locations, cultural backgrounds, and educational environments, all of which result in varying interpretations of culture. The regional differences and cultural diversity brought by the geographical and religious beliefs along the countries of the Belt and Road Initiative also contribute to the cultural discount and misinterpretation in the cultural transmission of China’s traditional ethnic sports. For example, there are problems of understanding bias and ineffective communication in the exchange of martial arts and Tai Chi culture with specific ethnic and regional characteristics among countries along the route (Pang Peipei, Tian Lin, 2018).

## **3. Thinking on the Countermeasures for International Exchange of Traditional Sports Culture in China**

The scholar Yan Dongxue believes that the strategy of international communication should first improve the institutional system of minority traditional sports projects, expand the material aspect of cultural exchanges through various forms of China’s ethnic traditional sports culture, and tap into the resources and unique advantages of various ethnic sports projects in order to be fully prepared for the international stage of communication. Secondly, enhance cultural confidence and vigorously promote excellent ethnic traditional sports culture. With the help of the “Belt and Road” policy, showcase China’s good sports culture and allow Chinese sports culture to go further in international exchanges. Finally, establish a diversified platform for sports and cultural exchanges, using the platform of mass media to open channels for sports and cultural exchanges, and promote and popularize China’s ethnic traditional sports culture (Yan Dongxue, 2021).

Scholars Cheng Ming and Yang Ling believe that it is necessary to strengthen the communication between different cultures, hold sports and cultural events with the characteristics of the “Belt and Road” initiative, promote Chinese ethnic traditional sports projects, explore new paths for hosting sports events, and create sustainable sports event brands. They also emphasize the need to enhance cultural confidence and vigorously promote excellent ethnic traditional sports culture. With the help of the “Belt and Road” policy, showcase China’s excellent sports culture and allow Chinese ethnic traditional sports culture to go further in international exchanges (Cheng Ming, Yang Ling, 2021).

Scholar Xue Hongbo is constructing a project system for traditional ethnic sports in order to improve the quality of the output of material and cultural resources of traditional ethnic sports. The current insufficient output of material and cultural resources in international

exchanges of traditional ethnic sports is actually an international manifestation of the weak development of traditional ethnic sports in China. In the process of international exchanges of material and cultural resources of traditional ethnic sports, it is first necessary to construct a complete project system for traditional ethnic sports. In the process of exploration, protection, rescue, and organization, a certain growth environment should be provided for traditional ethnic sports projects, and then they should be cultivated and matured before entering the international market. Secondly, efforts should be made to develop supporting facilities for various traditional ethnic sports projects. Strengthen the construction of regulations for traditional ethnic sports and enhance the internal and external strength of the cultural system of traditional ethnic sports. International exchanges of the cultural system of traditional ethnic sports should start from the infiltration of rules to trigger “emotional identification,” improve the level of understanding through the standardization of terminology and translation, broaden the cognitive channels through the dissemination of literary and artistic works, and fundamentally enhance the internal and external strength of international exchanges of the cultural system of traditional ethnic sports. Have confidence in the cultural traditions of traditional ethnic sports and showcase the competitive advantages of the spiritual and cultural aspects of traditional ethnic sports. The proposal of General Secretary Xi Jinping’s cultural self-confidence has provided guiding ideology for the development of the cultural traditions of traditional ethnic sports. The development of the cultural traditions of traditional ethnic sports should not be achieved by flattery and pleasing others but through introspection and self-awareness. In the construction of the “Belt and Road” initiative, the cultural traditions of traditional ethnic sports can seize this rare opportunity for development and showcase the unique sports spirit and cultural strength of our country in international exchanges, emitting a powerful voice (Xue Hongbo, 2019).

## References

- [1] Xi Jinping. Xi Jinping Talks on Governing the Country and the State Affairs: Volume 2[M]. Beijing: Foreign Language Press, 2017.
- [2] Zhu, J. (2005). The Influence of Ethnic Traditional Sports Culture on the Development of Western Sports. *Journal of Shanxi Normal University (Physical Education Institute)*, 20(2), 15-17.
- [3] Duan, A., Bai, J., & Tian, Z. (2005). Changes, Inheritance, and Development of Ethnic Traditional Sports Culture. *Journal of Sports Science*, 12(2), 54-56.
- [4] Xue, H., & Cheng, W. (2019). Research on International Exchange of Ethnic Traditional Sports Culture in the Context of the Belt and Road Initiative. *Journal of Sports and Culture*, (10), 74-80.
- [5] Li, Y., & Liu, N. (2017). Research on the Development of Ethnic Traditional Sports Culture under the Belt and Road Strategy. *Martial Arts Research*, (4), 104-107.
- [6] Pang, P., & Tian, L. (2018). Research on Strategies for International Exchange of Ethnic Traditional Sports Culture in the Context of the Belt and Road Initiative. *Chinese Martial Arts (Research)*, 7(02), 83-85.
- [7] Yan, D. (2021). Research on Optimization Strategies for the Exchange of Ethnic Traditional Sports Culture in the Context of the Belt and Road Initiative. In *Proceedings of the 2021 Belt and Road Sports Culture Academic Conference* (pp. 2). Xiangtan University.
- [8] Cheng, M., & Yang, L. (n.d.). Research on Strategies for the Stable and Long-term Development of Chinese Ethnic Traditional Sports Culture under the Belt and Road Initiative. In *Proceedings of the National Association of Martial Arts and Ethnic Traditional Sports Culture of China* (pp. n/a). National Excellent Traditional Culture Inheritance Base of Chinese Universities (Martial Arts), National School Sports Federation (Chinese Martial Arts). Protect, Study, and Inherit: Proceedings of the International Conference on Intangible Cultural Heritage of Chinese Sports in 2021. Graduate Affairs Department of Shenyang Sport University; School of Sports Training, Shenyang Sport University, 2021: 1.
- [9] Xue Hongbo. International Communication Strategy of Ethnic Traditional Sports Culture under the Belt and Road Initiative [C] // Chinese Association of Sports Science. Abstracts of the 11th National Sports Science Congress. Shenyang Sport University, 2019: 2.



# Innovative practice of RMP training mode under multi-level course objectives

Fang Li, Xiaofang Guo \*, Rong Liu\*

Qingdao City University, Shandong 266106, China.

---

**Abstract:** Currently, most universities focus on cultivating applied talents with indicators such as knowledge, skills, and qualities, and even emphasize comprehensive talents based on interdisciplinary research. This lays a stronger capital and foundation for career development planning, and can encourage students to break through professional limitations in the future, become comprehensive high-end technical and management talents, and achieve higher value. Here, this article proposes an innovative practice of RMP training mode under multi-level course objectives, and analyzes the adaptability and feasibility of this mode using the course of Human Resource Management as an example.

**Keywords:** Multi level course objectives; RMP; Training mode

---

## 1. Introduction

In the professional curriculum system of universities, there are always some relatively independent courses. These courses, as auxiliary courses, although not strongly related to professional courses in content setting, play an indispensable role in student cultivation. For students majoring in business administration and even other fields, the course of Human Resource Management holds irreplaceable importance. This article takes the course of Human Resource Management as an example to demonstrate how the teaching team used the RMP training method (as shown in the figure below) to achieve the multi-level goals of the course during the teaching process.

## 2. Multi stage goals lay the foundation for students' future development

In the past, when teaching the course "Human Resource Management" for non-human resource management students, teachers paid more attention to popularizing basic human resource management knowledge to students, in order to enable them to discover problems, judge right and wrong, and actively respond when facing job hunting before graduation and future practical work. There are differences in the management methods implemented by enterprises for employees in different positions, so students from different majors should have differences in learning and understanding the course of Human Resource Management. Teachers should also have different focuses and goals when teaching the course of Human Resource Management to students from different majors.

### 2.1 Initial objective

The initial goal of the Human Resource Management course should focus on knowledge and its application, which means that students should master the core knowledge of human resource management, such as job analysis, recruitment, training, performance, compensation, etc., and be able to analyze and solve human resource management problems in specific contexts. Non human resource management students have a relatively small proportion of positions related to human resource management in their future employment choices. This course cannot cover all the relevant theories, methods, technologies, etc. of human resource management. Therefore, during the teaching process, core knowledge is taught to students to help them understand and master, and to be able to analyze and solve specific problems in specific situations based on this, which becomes the basic goal of this course.

### 2.2 Mid level objective

The intermediate goal of the Human Resource Management course is to guide students to think from different roles, such as job seekers, employees, HR, managers, entrepreneurs, etc., propose diverse solutions, and continuously strengthen self-management in team learning and self-learning. On the issue of employment, teachers have always emphasized to students that majors should be the advantage of future career choices, rather than the concept of being confined. Therefore, during teaching, they continuously guide students to set aside their per-

sonal professional background, actively think about potential future career roles, and complete phased tasks in groups, exercising students' teamwork spirit, proactive sense of responsibility, and dialectical thinking ability. By implementing a fair and reasonable grading mechanism, students can strengthen their self-management and prepare themselves for entering the workplace in the future.

### **2.3 High order objectives**

The advanced goal of this course is to help students establish a correct career outlook, enhance confidence, actively explore and forge ahead, and empower the development of smart cities from the perspective of ownership. College students are the reserve talents of the country and the driving force for the future development of society and enterprises. The rapid development of information technology has brought numerous opportunities, but it has also had a huge impact on some professions or fields with strong substitutability, leading to poor employment prospects in many majors, and students in these majors even question their professional choices. At present, many cities are constantly introducing more competitive talent policies and measures in order to attract and retain talents. Talent policies have also expanded from the original postgraduate degree to undergraduate or even vocational education, which is very beneficial for college students.

## **3. RMP training achieves comprehensive improvement of students**

In the teaching process of "Human Resource Management" over the years, the author found that due to significant differences in students' professional characteristics and mastery of basic management knowledge, they are unable to establish a connection between this course and other courses during learning, resulting in insufficient awareness of the importance of this course among students. At the same time, this course is an interdisciplinary subject that extensively absorbs knowledge from multiple disciplines, with strong practicality and applicability. However, due to the limitations of the learning environment, there are significant differences between students' professional abilities and future required vocational skills. To address the above issues, the teaching team proposes an RMP training model based on the professional characteristics, personalized needs, and future social needs of students, in order to better achieve the multi-level goals outlined above.

### **3.1 R: Role**

It refers to the ability of students to establish role awareness, transition between employees, HR, managers, and entrepreneurs, and think about problems from multiple perspectives. Students have limited experience and often cannot immerse themselves in pre-set situations, resulting in being one-sided in thinking and problem-solving due to the influence of their profession. But they will gradually grow into employees, HR, managers, and entrepreneurs in the future. One of the tasks of teachers is to constantly guide students to establish role awareness, view a phenomenon from different roles, think about the reasons for the phenomenon from different roles, judge the methods and approaches to solve problems from different perspectives, and not be influenced by the thinking stereotypes that may be brought by their profession.

Especially in the issue of employment, teachers should guide students to break the traditional notion that "jobs that match their profession are more suitable for themselves", and make their profession their career advantage rather than a limitation. They should actively reflect on their abilities, interests, advantages, and what job they have a higher match with in their college career, or the gap between their comprehensive qualities required for their ideal job, and how to narrow the gap. For example, asking students to think, "As an interviewer for a mechanical company, you need to choose between a bachelor's degree in marketing and a bachelor's degree in mechanical engineering, and who would you choose?" Here, students need to consider multiple aspects such as the company's background, actual job requirements, professional skill barriers, and employee career development plans. Students must set aside the profession itself, consider employment costs and expected benefits from the perspective of the employer, and also consider what kind of salesperson is more professional and persuasive from the perspective of the target customer group.

### **3.2 M: Management**

Students are able to comprehensively analyze their strengths and weaknesses, and lay a solid foundation for entering the workplace in the future by strengthening self-management. In the course of Human Resource Management, personality and career choice are one of the

opening topics, allowing students to use SWOT for self analysis and preliminary thinking on future career choices. The school where the author is located is mainly aimed at students who meet the score line for third tier universities. Compared to other public universities, its popularity is not high. However, this does not mean that students will not necessarily be as good as students from well-known universities when it comes to employment. Teachers need to emphasize to students that the starting line may differ due to differences in school, major, subject grades, etc. The important factors that ultimately affect whether students can succeed in their careers are actually courage, perseverance, and innovation.

In the explanation of job analysis and quality models, students continue to understand the differences in employee quality requirements among different professions, find what they want and what suits them, and judge the gap between their current self and what they should become in the future. They also think about how to shorten the gap, develop stage plans, and overall goals. Teachers enhance students' active participation and thinking through group tasks, manage their roles well in the team, hone themselves through repeated tasks, enhance self-confidence, and engrave persistence in the depths of their thinking. They constantly discover new things, accept new concepts, and create new models, preparing themselves for truly entering the workplace in the future. For example, if a teacher sets interview scenarios for different groups that are completely unrelated to their major, the students in the interview group need to determine the job responsibilities and standards of the recruited position, and draw recruitment posters on the spot. The students in the job search team wrote resumes based on the recruitment requirements of the position, and self entered during interviews, demonstrating a certain level of adaptability in the face of the situation.

### **3.3 P: Plan**

Students are able to become partners in this course and future businesses, and develop clearer and more personalized career development plans. In terms of course content, teachers should fully consider the future practical needs of students, continue to refine key and difficult points, and reduce the proportion of traditional teaching; In terms of teaching methods, it is necessary to fully consider the cultivation of students' abilities in the course objectives. Through group discussions, demonstrations, simulated performances, etc., students can exercise their teamwork and adaptability abilities; In some procedural assessment and evaluation, the use of inter group evaluation and intra group ranking ensures student participation and fairness. By using the above methods, students can become partners in the course.

Teachers emphasize the changes in the future roles of students in different modules of human resource management, explain the functions that different roles should undertake, motivate and motivate students with stories of successful entrepreneurs, maintain a positive attitude and behavior of students, deepen their concept of becoming business partners, and thus have clearer career development goals. Youth are the driving force of the country and the nation, and their sense of identity and mission towards the country and the nation is the source that drives them to strive for progress. In teaching, they insist on instilling social and professional ethics in them, constantly improving and establishing correct worldviews, outlooks on life, and values, enhancing their sense of ownership and spirit, and becoming partners in society.

## **4. Summary**

Through continuous observation by the author and comprehensive feedback from students, it was found that after implementing a multi-level goal RMP training for the Human Resource Management course in some business management majors, students' overall satisfaction with the course improved, and the satisfaction and value points basically met expectations, verifying that this training model is indeed beneficial to the overall development of students. The author believes that other courses that have the same characteristics of teaching for multiple majors and strong practicality as this course are also suitable for this teaching model, but in specific implementation, teaching methods should be changed in combination with course objectives to ensure the achievement of teaching effectiveness.

## **References**

- [1] Su Rui. Research on the Development of Sichuan Minority Sports Tourism Based on RMP Theory [C]// Chengdu Institute of Sports. Proceedings of the 4th National Academic Symposium on Ethnic Sports. 2016:382-387.
- [2] Du Yongfeng, Li Yaju, Ma Yaqin. Research on the Development of Sports Tourism in Ili, Xinjiang Based on RMP Theory [J]. Tourism Overview, 2022(8): 148-150.

# It briefly describes the philosophical thoughts on human nature, sin and redemption in the Divine Comedy

Anbo Yang<sup>1</sup>, Linshan Bao<sup>2</sup>, Mingbo Xia<sup>3</sup>, Haijia Zuo<sup>4</sup>, Jiachen Ma<sup>1</sup>, Jiayi Wang<sup>5</sup>

1.College of Marxism, Yunnan Agricultural University, Kunming 650201, China.

2.College of Culture and Media, Chongqing University of Arts and Sciences, Chongqing 402160, China.

3.College of Landscape Architecture, Yunnan Agricultural University, Kunming 650201, China.

4.College of Science, Yunnan Agricultural University, Kunming 650201, China.

5.College of Foreign Languages, Yunnan Agricultural University, Kunming 650201, China.

---

**Abstract:** This study aims to explore the connection between the philosophical thinking of human nature, evil and redemption and the problems of human nature, evil and redemption in the contemporary society, and put forward the corresponding enlightenment and suggestions, so as to enrich people's understanding and understanding of these topics. This paper adopts the methods of literature analysis, text analysis and historical and cultural analysis to study the philosophical thinking on human nature, sin and redemption in the Divine Comedy, and through the in-depth interpretation and analysis of the words, image and symbol elements in the text, so as to show the significance of these thoughts in a comprehensive and deep way. The research in this paper shows that through the in-depth exploration of philosophical thinking in literary works, we can improve our understanding and understanding of human nature, evil and redemption, and provide important reference and enlightenment for the development and change of contemporary society.

**Keywords:** The Divine Comedy; Human nature; Sin; Redemption

---

## Introduction

The Divine Comedy is one of the most famous literary works of the Italian Renaissance, and it is the representative work of Dante. This masterpiece is not only a literary work, but also a masterpiece of philosophical thinking. Among them, the philosophical thinking of human nature, sin and redemption has a profound practical significance and value. At present, with the development and progress of the society, people's spiritual and cultural needs are constantly increasing, and new requirements are put forward and challenges for the research of the Divine Comedy.

At present, the academic circle has accumulated some of the research of the Divine Comedy, but there are still some problems and deficiencies. On the one hand, most of the past studies have explored the Divine Comedy from the perspective of literature, and the enlightenment of the philosophical thinking and the contemporary social connection has not been deeply studied. On the other hand, due to the literary value and historical status of the Divine Comedy, some researchers overbeautify it and ignore the existing problems and limitations.

Therefore, this paper will explore the philosophical thinking of human nature, sin and redemption in the Divine Comedy, and analyze and interpret the actual situation of contemporary society. At the same time, this paper will dig out the problems and limitations existing in the Divine Comedy, and put forward new thoughts and viewpoints. The literature research method and logical analysis method are adopted to conduct in-depth analysis and interpretation of the text, and strive to explore its deep significance and value.

The significance of this paper is that, on the one hand, we can deeply explore the philosophical thinking in the Divine Comedy and enrich its cultural connotation; on the other hand, we can link the philosophical thinking in the Divine Comedy with the contemporary society to explore its practical meaning and value. At the same time, this paper can supplement and perfect the past research, and put forward new thoughts and views.

## 1. Philosophical thoughts on human nature in the Divine Comedy

### 1.1 The Nature of human nature and the existence of evil

In the Divine Comedy, the discussion of human nature and evil has a profound philosophical thinking. In terms of the nature of human

nature, the Divine Comedy believes that people are human because they have reason and free will. At the same time, the Divine Comedy also reveals that the root cause of evil lies in the corruption of human nature, or the lack of a correct grasp of reason and free will. These philosophical thoughts suggest that our contemporary society is also facing the problems of human corruption and increasing evil behavior. In essence, the solution to this aspect requires us to comprehensively improve the quality and moral level of our people, as well as to establish a perfect legal system, with the law to protect people's freedom and dignity.

At the same time, the Divine Comedy also discusses the complexity of human nature and the limitation of free will. The freedom of will is the fundamental feature of human nature, but the individual will is sometimes limited by coming from society, family, gender, love relationship, or other factors. People's values, moral concepts and codes of conduct are often bound by these factors, making people's reason and free will are greatly restricted. This tells us that when facing various social factors, we must, on the basis of protecting free will, keep rational, correctly understand our own values and codes of conduct, and make appropriate adjustments to avoid going to extremes or excessive passivity.

Finally, as for the redemption and hope of human nature, the Divine Comedy believes that it can only be obtained through the purification of faith and heart, which enables people to transcend all boundaries and self and obtain true liberation. This kind of thought inspires us that despite the face of difficulties and setbacks, we should also adhere to the inner belief and pursuit, and believe that we can overcome the difficulties and obtain real redemption and hope.

## **1.2 The complexity of human nature and the limitation of free will**

The complexity of human nature is an important philosophical thinking in the Divine Comedy, which also has great enlightenment significance to our contemporary society. In the Divine Comedy, human nature is a complex and multi-faceted concept that contains both good qualities and upright morality, as well as evil desires and evil actions. At the same time, human nature also has free will, which can decide their own actions and choices.

However, the free will of human nature also has its limitations. In the Divine Comedy, human beings are double bound by the will of God and the inner desire of themselves. While on earth, Dante encountered the tragic punishment of their souls, precisely because they failed to use their free will correctly. In the European kingdom, comparable to heaven, Dante's humanity has its limitations. There, people's choices have been preallowed or denied by God, free will is deprived, they can only be content with their living arrangements, and can not expect their destiny to change.

These reflect the complexity of human nature and the limitations of free will. In contemporary society, we may also be bound from different directions, such as social norms, authority, tradition, economy and so on. These may restrain our free will and make us lose our choice. Therefore, then how to deal with these limitations? For this question, the Divine Comedy provides a basic train of thought, that is, the wisdom of people makes people have an ability to transcend themselves, to transcend all limitations and find their own inner real strength, just as Dante's journey.

## **1.3 Salvation of humanity and the existence of hope**

In the Divine Comedy, the existence of human nature is not only reflected in the existence of evil, but also in the existence of hope and redemption. This existence shows that, between evil and goodness, human nature is a complex and unique form of being. In human nature, salvation exists, which is not only reflected in god's generosity and kindness, but also that everyone has a chance to regain redemption. For example, in purgatory, people undergo the tests of suffering and pain, but these tests are not to let people sink in evil forever, but through the lessons learned in suffering to obtain redemption and find the way to heaven.

Salvation is accompanied by the existence of hope. In contrast to evil, hope gives people the courage and strength to overcome difficulties and setbacks and meet the challenges of the future. As the poem says: "Because of hope, life will be better!". Throughout the Divine Comedy, hope is filled with the whole story, no matter in hell, purgatory or heaven, the light of hope always shines on the glory and dignity of human life. At any time, as long as the hope, perseverance, can overcome the original insurmountable obstacles, taste the taste of victory.

In short, the Divine Comedy involves not a single philosophical theme, but is full of complex and diverse aspects of human nature. Through the thinking of human nature, sin and redemption in the Divine Comedy, we can see many problems in contemporary society, learn how to integrate the concept of philosophical thinking into real life, and take it as a guide to position our own values.

## **2. Philosophical thoughts on sin in the Divine Comedy**

### **2.1 Definition and kind of evil**

In the Divine Comedy, the definition and variety of evil are very rich and complex. Dante gave his own philosophical insight on this question. First, Dante believes that sin is an act against the divine will, and an opposition and conflict between man and God. He points out that sin can be divided into two categories: original sin and personal sin. Original sin is the common sin of mankind, referring to the original crime of Adam and Eve, namely the betrayal of God. Individual sin refers to the sin for which each person acts alone, and is caused by the action of human free will. Dante believes that the essence of sin lies in the pursuit of the wrong love, the greed for worldly wealth and prestige, and the pursuit of carnal desire.

In Dante's philosophical thinking, the consequences and punishment of evil are closely related to their kind. For the original sin, it is believed to have come from God's punishment for Adam and Eve. As for individual crimes, Dante thinks they will be punished both in this life and in the afterlife. In hell, sinners suffer different punishments and sufferings, depending on the kind and nature of sin. When Dante describes hell in the Divine Comedy, he clearly outlined the specific punishment for each evil: the greedy, the jealous, the back, and so on, all receive different forms of punishment.

Dante is also exploring the evil of redemption and repentance. After passing through hell and purgatory, sinners are eventually elevated to heaven, marking the moral rebirth and redemption of sinners. But Dante also believes that redemption is not easy to get, which requires a person to pay long-term efforts and struggle. Heaven means perfection and tranquility, and Dante in the Divine Comedy depicts a series of nine heavenly realms, which represent the different degrees of morality, and show that moral growth and promotion require constant effort and sacrifice.

### **2.2 Consequences and punishment of evil**

Crime is an important part of human behavior, and the thinking of evil and punishment is deeply reflected in the Divine Comedy. First of all, the consequences of evil behavior are inevitable, so when thinking about evil, human beings need to be deeply aware of its consequences and effects. In the Divine Comedy, the consequences are vividly depicted as all kinds of hell scenes, and the sinners are tortured by all kinds of suffering in the scenes, and their depiction is vivid and profound, which makes people deeply feel the terrible consequences of the evil behavior.

When discussing the punishment of evil, we need to think about the purpose and effect of punishment. In the Divine Comedy, the purpose of punishment is not only to make the sinners deserve it, but also to effectively reform the thoughts of the sinners, so that they can realize the consequences of the criminal acts in the suffering, so as to repent. This kind of punishment with the goal of repentance is also of enlightening significance in the contemporary society. Because in the real society, the simple punishment is often difficult to achieve the purpose of reforming the behavior, more is to cause more dissatisfaction and resistance. Therefore, drawing lessons from the thought of evil punishment in the Divine Comedy and taking repentance as the key link can provide important enlightenment for the contemporary society.

### **2.3 Salvation and repentance of sin**

Salvation means to free oneself from the original evil and regain happiness and harmony through certain actions or methods. In the novel, this relief refers to the ultimate arrival in heaven and the escape from the original sin and pain by accepting the punishment and the judgment of heaven. Regret refers to the reflection and understanding of their original wrong behavior or thoughts, so as to achieve the purpose of reform.

In the novel, the main character, Dante, asks the god for help and gets a chance to get redemption. But, with such an opportunity, he

must revive himself through suffering and punishment, a process that must be filled with repentance and repentance.

In Thomas Aquinas's philosophy, redemption and repentance require divine grace and enlightenment. However, in the Divine Comedy, concrete redemption and repentance need to be achieved through actual action and self-change.

In the contemporary society, redemption and repentance are still an important topic. Many people face setbacks and pain, and unconsciously look for ways to free themselves. Through the study of the Divine Comedy, we can find that in a certain environment, it needs a deep understanding and real self-change to achieve the purpose of redemption and repentance.

In short, in the Divine Comedy, the redemption and repentance of evil is an important means for the protagonist to explore himself and grow up gradually. This process is full of difficulties and tribulations, but the ultimate goal is to rekindle the meaning and value of life. In the contemporary society, we can draw a lot of inspiration from it, and help us to better understand ourselves and treat ourselves in the way of life.

### **3. Philosophical thoughts on redemption in the Divine Comedy**

#### **3.1 Redemption and revelation in the contemporary society**

In the contemporary society, redemption is still an eternal theme. In the Divine Comedy, the meaning of redemption is to meet with god and free the evil, which is not only to save a person, but also to the rescue of the whole human race. For today's society, redemption has broader connotations and forms of expression.

First, redemption in contemporary society has gone beyond religion and been extended to the most basic social structures and interpersonal relationships. Through different forms of social action, such as philanthropy and volunteering, people can deliver positive forces, help people in need, and let them regain confidence, courage and hope. At the same time, in the contemporary society, there are numerous dilemmas and challenges, which sometimes seem insoluble and may require more complex solutions. Salvation means upholding the truth and kindness, dealing with these problems with a calm and clear mind, and trying to change their status quo.

Secondly, redemption in contemporary society has a positive and subtle role in many aspects. Salvation can be used to measure social justice and development, and can help people build more equal and harmonious social relations. At the same time, for people who have experienced life difficulties, redemption is also a path to help them regain their dignity and self-worth. Most importantly, redemption can teach people to cherish and cherish the harmony of nature, so as to effectively maintain our living environment and future.

In this context, the thought of redemption in the Divine Comedy has a profound enlightenment for the contemporary society. Redemption not only belongs to the category of individual life, but also is the core of a beautiful society and the concrete embodiment of the ideal state. Only by actively believing in and practicing redemption, can people truly feel the value and meaning of life, and can do their part for the harmony and development of the society.

### **4. Conclusion**

Through an in-depth discussion of the philosophical thinking of human nature, sin and redemption in the Divine Comedy, this paper finds two main research discoveries and contributions.

On the one hand, in terms of discussing human nature, we find that the Divine Comedy has multiple manifestations of human nature, including pure love, justice and kindness, the existence of evil and evil, and even the chaos and confusion of human nature. But, it is these in-depth exploration of human nature, let us better understand and understand the diversity of human nature and contradiction, also let us realize in the contemporary society, how to correctly view the complexity and diversity of human nature in various fields, how to promote the realization of human justice and kindness, has the very important significance.

On the other hand, in the discussion of redemption, we find that the thinking of redemption in the Divine Comedy is deep and comprehensive. By thinking about all levels of redemption, including individual, social, historical and other aspects, we can realize the complexity and long-term nature of redemption, and we can also understand the fundamental and importance of redemption. At the same time, we can also combine these thoughts with the construction of human civilization and global governance in contemporary society, seek better solu-

tions, promote the realization of redemption work, and have a positive impact on the progress and development of human society.

To sum up, this paper makes an in-depth discussion and analysis of the philosophical thinking of human nature, sin and redemption in the Divine Comedy, whose main contributions and discoveries are mainly reflected in the diversity and contradictory understanding of human nature, as well as the in-depth thinking and inquiry of redemption. Through these studies, we can better realize the complexity and diversity of human civilization, understand the importance of promoting the realization and redemption of human justice in contemporary society, and provide important enlightenment and direction for future research.

## References

- [1] Li Peng. On the Divine Comedy's response to the medieval philosophical debate [J]. Journal of Nanyang Normal University, 2008:42-47.
- [2] Ji Rutian. Humanist aesthetic thought in the Divine Comedy [J]. Modern Women (theoretical edition), 2014:195-196.
- [3] Hou Chaoyang. On the reduction and perfection of human life in the Divine Comedy [J]. Journal of Xinyang Normal University (Philosophy and Social Sciences Edition), 2012:121-125. [4]Cui Ying, Lu Aijun. On the relationship between man and gods and the essence of theology [J]. Xiang Chao: Theoretical Edition, 2007:54-54.
- [5]Zhu Ke. The Human interpretation of the Divine Comedy [J]. Journal of Inner Mongolia University for Nationalities, 2012:18-19.
- [6]Zhang Dai. Religious ethics of the Divine Comedy and its contemporary values [J]. Learning Monthly, 2011:47-48.
- [7]Ding Zhuo. The new image in the Divine Comedy —— Take Hell as an example [J]. Journal of Changchun University (Social Science Edition), 2019:65-71.
- [8]Zhu Ke. The Human interpretation of the Divine Comedy [J]. Journal of Inner Mongolia University for Nationalities, 2011:24-25.
- [9]Yang Ruyue. Divine Comedy —— Soul travel [J]. Dagan Weekly, 2012:19-19.
- [10]Yuan Xiaohui. Reason and the Christian Culture in the Divine Comedy [J]. Journal of Central South University for Nationalities (Humanities and Social Sciences Edition), 2005:81-82.



# Application research of guided inquiry teaching mode in the teaching of Introduction to Educational Studies

Qiongxian Xiang, Ruixian Lv

Geely University of China, Chengdu 641423, China.

---

**Abstract:** Introduction to Education is an important course to cultivate students' comprehensive knowledge of education, and traditional teaching methods are often difficult to arouse students' interest in the subject and in-depth thinking. The guided learning model can integrate the goals of self-directed learning and in-depth investigation, update teachers' teaching concepts, change the status quo of students' passive acceptance of knowledge, stimulate students' learning initiative, and exercise students' ability to explore and cooperate. However, the application of the guided learning programme to the teaching of Introduction to Education is not without challenges, such as students' insufficient understanding of the subject and the effect of independent learning.

**Keywords:** Guided learning programme; Introduction to education; Learning outcomes; Engagement

---

## 1. Guided Learning Programme

An introductory plan is a widely used instructional design tool in course instruction that guides students in their independent study and preparation prior to class in order to better participate in classroom activities. It usually contains elements such as learning objectives, an outline of the course content, independent learning tasks and problem guides to provide students with a clear learning route. In terms of learning objectives, students are guided to understand the course goals and learning expectations. The focus of instruction is clarified to enable students to preview and study with purpose. In the area of Course Content Outline, outlines the theme and core concepts of the lesson. Provide a course framework to help students make sense of the logical structure of the course content. In terms of independent study tasks, encourage students to independently study the material before class to build up the necessary basic knowledge. Provide references, web resources, etc. to support students' in-depth understanding of the course topics. In terms of problem-guidance, targeted questions are asked to guide students' thinking and discussion.

## 2. Introduction to Education Course

As an introductory course for education majors, the Introduction to Education course plays the role of guiding students to gain an in-depth understanding and study of the field of education. It not only provides students with a broad framework of educational knowledge, but also enlightens their understanding of educational philosophy, policy and practice. Firstly, in terms of introduction to the subject and the building of basic knowledge. The Introduction to Education programme provides students with a comprehensive understanding of the discipline of education and helps them to build up the foundation and theoretical framework of the discipline, which is an important starting point for training professionals. Secondly, in terms of educational thinking and professionalism. Through Introduction to Education, students are able to come into contact with different educational ideas, theories and methods, and develop the core literacy of the education profession, including knowledge of educational ethics and educational psychology.

## 3. Problems in the application of the guided study teaching model in the teaching of Introduction to Pedagogy

### 3.1 Aspects of student preparation

Insufficient preparation of students. Students' insufficient preparation for the guided study plan due to insufficient time, insufficient motivation to learn and insufficient understanding of the task requirements affects the classroom effect. First of all, as a teaching tool that guides students to learn independently and prepare in advance, the guided study plan has certain requirements for students' independent learning ability and time management ability. However, in practice, we find that many students do not make full use of the guided study plan, and

one of the main reasons for this is that students are not well prepared. Students' lack of preparation is reflected in several aspects. On the one hand, there is insufficient time. Due to heavy class workload or other activities, students often cannot spare enough time to prepare for the contents in the guided learning programme. This sense of time urgency will lead to students going through the motions in their previews and failing to understand and think deeply. On the other hand, there is insufficient motivation for learning. Some students are not interested in certain subjects or topics and therefore lack the motivation to study them in depth. In this case, even if the guided study programme is designed brilliantly, it is still difficult to attract students' attention, resulting in poor pre-study results.

### **3.2 Difficulty of task design**

The difficulty of task design makes it difficult to meet the needs of all students. There are big differences in students' learning abilities and backgrounds. Some students need more guidance and support, while others feel that the guided learning programme is too simple. The purpose of using guided learning programmes is to guide students to learn independently and develop their independent thinking and problem-solving skills. However, in practical application, the implementation of guided learning programmes faces many problems, among which the difficulty of task design is particularly prominent. Task design is one of the key aspects of the guided learning programme. An excellent introductory programme should stimulate students' interest in learning and guide them to actively explore knowledge through reasonable task design. However, in reality, due to the large differences in students' learning abilities and backgrounds, designing a task that is neither too simple nor too complex is often tricky for teachers. For some students, the tasks in the guided learning programme are too simple, resulting in a lack of a sense of challenge in the process of completion and hence boredom in learning.

### **3.3 Feedback on student learning**

In terms of student learning feedback, although the guided learning programme can stimulate students' active learning interest, however, sometimes students' feedback is not timely or not detailed enough, which brings certain troubles to teachers. This situation makes it difficult for teachers to fully understand students' preparation before class, thus affecting their ability to fully grasp the teaching process and adjust teaching strategies in a timely manner. The timeliness of student feedback is a crucial part of the learning process. However, the design of guided learning programmes often focuses on inspiring students' independent learning, which may result in students' inadequate understanding of the pre-class tasks or their failure to complete the tasks within the specified time. Due to the lag in student feedback, teachers may not be able to quickly detect problems that students may encounter in their independent learning process, making it difficult to provide targeted guidance and support. Finally, the lack of detail in the feedback is also a problem. Students' feedback is not only a simple report on the completion of the task, but also an expression of the problems encountered during the learning process, confusion, and understanding of knowledge.

## **4. Strategies for the application of the guided study teaching mode in the teaching of Introduction to Pedagogy**

### **4.1 Strategies for student preparation**

The guided learning programme usually contains rich subject information and learning tasks, but some students may be troubled because they are unfamiliar with the structure of the guided learning programme or their subject knowledge is not well understood. In such cases, teachers may adopt targeted strategies, such as providing clear instructions on how to use the guidebooks and demonstration examples, to help students better understand and make use of the guidebooks. Secondly, students may have difficulties in planning their study time and task completion. Independent learning requires students to have good time management and task planning skills, but some students may face inefficiencies due to lack of experience or academic self-motivation. To cope with this challenge, teachers can teach students effective time management skills, provide advice on task decomposition, or even organise training courses on study skills to help students improve the efficiency and quality of their learning.

## 4.2 Strategies in terms of task design difficulty

On the one hand, teachers can adjust the difficulty by setting clear task objectives and stages. Setting clear learning objectives in the guided learning programme helps students understand the focus and direction of the tasks. At the same time, breaking down the tasks into different stages and gradually increasing the difficulty enables students to go deeper into the subject content step by step. Such a design helps to meet the academic needs of different students, not only does it not make some students feel overly pressurised, but also inspires students with a certain foundation in the subject to explore in depth. On the other hand, teachers can make skilful use of inspiring questions to guide students to think and discuss. In the task design, open-ended and thought-provoking questions can prompt students to think about the multi-faceted nature of the problem, thus increasing the difficulty of the task. This approach can stimulate students' active learning interests and develop their problem-solving abilities without making the task too steep in difficulty.

## 4.3 Strategies in terms of students' learning feedback

On the one hand, establishing open communication channels is an effective way to collect students' learning feedback. Teachers can encourage students to share their learning feelings, difficulties and suggestions by organising regular student symposiums, setting up online feedback platforms and opening feedback mailboxes. Maintaining good communication with students and making them feel that teachers care about their learning can help motivate students to participate more actively in the feedback process. On the other hand, responding to students' feedback in a timely manner expresses the importance of their opinions and provides clarification on the suggestions that may be adopted. Students expect attention and response from the teacher when they provide feedback, so responding to feedback in a timely manner is key to establishing an interactive learning environment. Teachers can respond by thanking students for their participation, explaining their understanding of their feedback, and clarifying the steps to be taken to increase students' trust in the feedback.

## 5. Conclusion

The use of guided learning programme gives students a wider space for independent learning. The application of the guided study programme teaching mode in the Introduction to Education course opens up an effective path for improving teaching quality and cultivating students' comprehensive literacy. In order to cope with the dilemmas and challenges, teachers need to deepen their teaching concepts, consolidate the students' subject foundation, create a good learning environment, and further improve the teacher training system. Only through continuous practice and optimisation can the guided learning teaching model better release its educational potential and provide students with a more in-depth and inspiring learning experience.

## References

- [1] Robert Weston Siscoe. Teaching & Learning Guide for: The Epistemic Aims of Democracy[J]. *Philosophy Compass*,2023,18(11): 56-57.
- [2] Robin Zheng. Teaching & Learning Guide for: Theorizing Social Change[J]. *Philosophy Compass*,2023,18(10): 3-4.
- [3] Siemens, G. (2013). Artificial intelligence and personalized learning: A new paradigm. *Educational Technology*, 53(3): 21-24.

First author's profile:

name: Xiang Qionxiang .

1.Geely University of China

2.The National University of Malaysia

Research field: Curriculum and Teaching.

Second author's profile:

Name: Lv Ruixiang .

1.Geely University of China

Research field: Pedagogy, Educational Management

# A Study on the Application of Group Cooperative Learning Model in the Teaching of Introduction to Education

Qiongxiang Xiang, Ling Xiao

Geely University of China, Chengdu 641423, China.

---

**Abstract:** Introduction to Education is an important course for training students to have a comprehensive understanding of the discipline of education. Traditional teaching methods are difficult to stimulate students' enthusiasm for learning and promote in-depth thinking. In order to solve this difficulty, a group co-operative teaching mode has been introduced, aiming to integrate the dual objectives of group co-operative discussion and in-depth exploration of the subject. This can update teachers' teaching concepts, change the status quo of students' passive acceptance of knowledge, stimulate students' learning initiative, and cultivate students' ability of inquiry learning and cooperative learning. However, the adoption of group co-operative teaching in teaching is not without challenges. Problems such as insufficient understanding of the subject matter, as well as the efficiency of teamwork and independent learning, can arise in students' independent learning and group work.

**Keywords:** Group cooperation; Learning mode; Introduction to pedagogy; Learning effect; Degree of participation

---

## 1. Cooperative group learning mode

The cooperative group learning model is a teaching method that aims to achieve joint learning and cooperative problem solving by organising students into groups and engaging them in learning activities together. This teaching method aims to promote students' teamwork, communication skills and critical thinking, and to improve learning outcomes. Group work requires students to divide up the work, learn from each other and promote critical thinking. In terms of division of labour, cooperative group learning emphasises interaction and cooperation among students, and promotes the co-construction and sharing of knowledge through collective efforts to solve problems. Group members usually share different roles and responsibilities in learning tasks, drawing on their respective expertise and interests to achieve more efficient learning outcomes. In conclusion, the application of cooperative group learning in an introductory course on education is particularly effective in promoting students' integrated understanding of educational theory and practice, as well as developing teamwork and critical thinking skills.

## 2. Introduction to Education Courses

The Introduction to Education course, as an introductory course for education majors, plays the role of guiding students to gain a deeper understanding and study of the field of education. It not only provides students with a broad framework of educational knowledge, but also enlightens their understanding of educational philosophy, policy and practice. Firstly, in terms of introduction to the subject and the building of basic knowledge. The Introduction to Education programme provides students with a comprehensive understanding of the discipline of education and helps them to build up the foundation and theoretical framework of the discipline, which is an important starting point for training professionals. Secondly, in terms of educational thinking and professionalism. Through Introduction to Education, students are able to come into contact with different educational ideas, theories and methods, and develop the core literacy of the education profession, including knowledge of educational ethics and educational psychology.

## 3. Problems in the application of group cooperative learning mode in the teaching of Introduction to Pedagogy

### 3.1 The problem of uneven student participation

The application of cooperative group learning mode in the Introduction to Education course can provide an active learning platform for students, but at the same time, it also faces a series of challenges, and one of the notable problems is the uneven participation of students

in the group. The existence of this problem may affect the effectiveness of group collaboration and the overall development of each student in the learning process. Uneven student participation is mainly reflected in the fact that some students are more inclined to silently accept the views of other members of the group and less inclined to actively express their own views. Such behaviour may stem from students' personality differences, social pressure or a sense of lack of confidence in their own views. In group work, such uneven participation may result in some students' views being ignored, reducing the comprehensiveness and integrality of group collaboration.

### **3.2 Team conflict problems**

While the application of cooperative group learning model in the Introduction to Education course provides students with opportunities for interaction and collaboration, it also faces the problem of team conflict. Such conflicts may arise from differences in students' opinions, perspectives, and ways of working together, negatively affecting the cooperative atmosphere of the group and hindering the possibility of students' all-round development. It is common for students to experience team conflict due to differences in opinion. Each student in a group carries a unique way of thinking and point of view, and during the process of co-operation, these differences may trigger arguments and a clash of differing opinions. This conflict may lead to tension within the group, making it difficult for students to reach agreement and reducing the effectiveness of group collaboration.

### **3.3 Task division problem**

In the cooperative group learning model, students have different disciplinary backgrounds and professional interests in their groups, which may lead to an insufficiently rational division of tasks, thus affecting the effectiveness of group learning. The existence of this problem may trigger academic incoherence, weaken the overall effectiveness of group co-operation, and hinder the possibility of students' all-round development. First of all, the differences in disciplinary backgrounds and professional interests of different students may lead to an uneven division of tasks within the group. Some students may be more adept at specific areas of knowledge, while others may be more interested in other areas. Failure to take these differences into account in the division of tasks may result in some members being overburdened, while others may feel a lack of commitment and satisfaction in the task.

## **4. Strategies for the application of group cooperative learning mode in the teaching of Introduction to Pedagogy**

### **4.1 Improving the evenness of student participation**

Uneven student participation is a common problem in cooperative group learning, which may lead to some students being marginalised within the group and affect the effectiveness of cooperation. To address this problem, teachers can adopt a range of strategies to promote more even student participation in group co-operation and create a fair and congenial learning environment. Teachers can focus on team building in the early stages of group formation to learn about group members' interests, professional backgrounds, academic goals, and other information that will help to develop a more trusting and congenial group atmosphere. In the early stages of group formation, teachers can host some team activities to encourage students to know and trust each other better, so as to reduce shyness and increase participation. Design inspiring tasks and activities to stimulate students' academic interest. By designing interesting and challenging tasks, students' curiosity and desire for knowledge can be stimulated. The inspiring and engaging nature of the tasks can make each student more motivated to participate in group work, thus alleviating the problem of uneven participation.

### **4.2 Promoting teamwork and resolving conflicts**

Establishing good communication channels is the basis for dealing with team conflicts. Teachers can encourage team members to engage in open and honest communication and encourage them to express their views, needs and feelings. To avoid misunderstandings and unnecessary conflicts, team members are advised to keep an open mind and be ready to share and listen during discussions and co-operation. Use effective strategies for conflict resolution, such as negotiation and compromise. When there are differences among team members, teach-

ers can guide them to negotiate and find common solutions. By working together to find compromises, conflicts can be resolved and team goals can be achieved. Teachers can provide relevant training in conflict resolution skills to help team members better handle disagreements. Setting up clear team goals and division of roles can help reduce team conflict. When team members have a clear understanding of their respective tasks and responsibilities, conflicts arising from unclear roles can be reduced. Teachers can begin teamwork by clarifying the team's goals and assigning clear tasks to each member to ensure that everyone is clear about their responsibilities.

### 4.3 Rational division of labour for tasks

Teachers can clarify the task objectives and requirements before the start of group work, stressing the importance of each task in the overall learning. Through clear task objectives and requirements, it can help students better understand the core content of the task and contribute to a reasonable division of labour. At the same time, emphasising the contribution of each task to the overall group work stimulates students' sense of responsibility and makes them take the division of labour more seriously. The use of student-selected tasks allows students to choose their own division of labour based on their interests, professional backgrounds and skills. This ensures that each student is involved in an area they are interested in or specialise in, increasing motivation for task completion. It also enables a more complementary and coordinated division of tasks within the group, thus improving overall learning outcomes. In addition, teachers can guide students to engage in effective communication and negotiation in order to reach an agreed plan for the division of tasks. In group work, students are encouraged to engage in discussions and share each other's interests and professional expertise in order to better understand their respective strengths. By reaching consensus through negotiation, a more scientific and reasonable division of tasks can be formed, improving students' satisfaction and the effectiveness of cooperation.

#### Conclusion

The cooperative group learning model provides students with opportunities for collaborative learning. The application of the cooperative group learning model in the Introduction to Education course provides an effective way to improve the quality of teaching and develop students' comprehensive literacy. However, in order to overcome the difficulties and challenges involved, it is necessary to continue to deepen the teaching concepts, strengthen the students' foundation in the subject, build a good learning environment, as well as further improve the training system for teachers. Only through continuous practice and improvement can the cooperative group learning model better fulfil its educational potential and provide students with a more in-depth and inspiring learning experience.

### References

- [1] Xue Cao . Research on the Application of Group Cooperative Learning Mode in College English Teaching in the Age of "Internet +"[J]. *Frontiers in Educational Research*, 2019(07): 3-4.
- [2] S Sutherland, PT Stuhr, J Ressler, C Smith. A Model for Group Processing in Cooperative Learning[J]. *Journal of Physical Education, Recreation & Dance*, 2019,90(03): 56-57.
- [3] Siemens, G. Artificial intelligence and personalized learning: A new paradigm. *Educational Technology*, (2013), 53(3): 20-23.

### Author's Profile:

First author's profile: name: Xiang Qiongxian . Geely University of China

Country: China. Research interests: curriculum and teaching.

Second author's profile: Name: Xiao Ling . Geely University of China

Country: China. Research Interests: Pedagogy, Educational Management

# Discourse Analysis in Junior High English Material Adaptation: Holistic Unit Teaching and Activity-Based Approaches in China

Chunyi Chai

Yunnan Normal University, Kunming 650000, China.

---

**Abstract:** This paper addresses the misalignment of junior high English teaching materials in China, with reference to the 2022 English Curriculum Standards. Using discourse analysis, it evaluates the “Go for it!” textbook, suggesting a shift to holistic unit-based teaching and activity-based learning. Proposed adaptations include integrating Western and Chinese educational methods and enhancing critical thinking and cultural awareness. The study underscores the need for materials that foster language skills, cultural understanding, and critical competencies, realigning them with contemporary educational philosophies.

**Keywords:** Discourse analysis; Holistic unit teaching; Activity-based approach

---

## 1. General information

The “English Curriculum Standards for Compulsory Education (2022 Edition)” in China focuses on core English competencies, incorporating language skills, cultural understanding, critical thinking, and learning capabilities within a six-element integrated learning framework. This approach moves away from traditional knowledge and skills-based teaching, promoting moral character and holistic development. It advises educators to emphasize thematic significance and establish unit-based objectives aligned with core competencies. However, a reevaluation of current materials, especially in junior high schools in Yunnan Province, is required to ensure alignment with these standards and contemporary teaching methodologies.

## 2. Literature review

### 2.1 Discourse analysis

Discourse analysis is vital in aligning teaching materials with new standards, assessing content authenticity, relevance, and cultural appropriateness. It helps ensure materials foster critical thinking, cultural awareness, and linguistic competence in students. Additionally, discourse analysis is key in reconciling Western educational methods with Chinese educational values, enhancing China’s modern educational landscape.

#### 2.1.1 Western research into discourse analysis

Since the 1980s, advancements in course material analysis have been led by foreign experts who have set influential standards and methodologies. Cunningsworth (1984) established four principles for evaluating teaching materials, focusing on learner needs, authentic language use, effective learning methods, and linking materials to learning objectives and engagement. Tomlinson (1998) emphasized innovative materials that connect learners with real-life experiences for maximal potential. These methodologies highlight the importance of authentic content and a learner-centered approach, catering to diverse learning styles and promoting active language learning.

#### 2.1.2 Chinese research into course analysis

In China, course analysis research, influenced by foreign methodologies, developed unique evaluation standards. Hu Zhuangling (1995) emphasized alignment with teaching syllabi and effectiveness, while Liu Daoyi (2004) integrated national curriculum standards, focusing on compliance with national policies, students’ developmental needs, and practicality in regional educational reforms. Distinctively, Chinese course analysis melds national standards and political considerations, aiming to combine English cultural assimilation with Chinese integrity, acknowledging the socio-political impact of language.

## 2.2 The new English Curriculum Standards for Compulsory Education

The 2022 revision of China's "English Curriculum Standards for Compulsory Education" represents a significant shift towards contemporary pedagogical models, emphasizing comprehensive linguistic proficiency over traditional vocabulary and grammar focus. This holistic, learner-centered curriculum integrates theory and practice with real-world relevance and transitions from an exam-centric to a competency-based assessment system, blending formative and summative evaluations. This update merges Western and Chinese educational philosophies, offering a dynamic framework for English education in China's evolving educational landscape.

### 2.2.1 The approach of unit-based integrated teaching

The revised English curriculum standards in China endorse a unit-based integrated teaching approach, which is a significant departure from traditional language education methods. This approach integrates various language skills, knowledge, cultural insights, and learning strategies within comprehensive thematic units. Teachers are encouraged to develop lessons that include a variety of activities such as reading, discussions, research, and interactive tasks, all aimed at enhancing practical language use and cultural understanding. This student-centered methodology fosters active engagement, inquiry, collaboration, and the development of linguistic proficiency and key competencies.

In essence, these standards represent a transformative shift towards a more holistic and integrative language education framework, seeking to cultivate a comprehensive skill set and broader competencies in students.

### 2.2.2 The activity-based approach

The activity-based approach in China's revised English curriculum standards for compulsory education underlines a dynamic, student-driven learning methodology. It elevates students as pivotal agents in acquiring language skills, encouraging their active participation in diverse, authentic linguistic tasks, including oral and written communication. Educators assume the role of facilitators, steering students towards applying their language skills in practical situations. This strategy accentuates experiential learning, aiming to boost student motivation and language proficiency via engaging, practical tasks such as role-plays and group projects.

Ultimately, this approach aspires to enhance students' linguistic abilities and comprehensive competencies through proactive, experiential engagement in English learning.

## 3. Case study

### 3.1 The unit-based analysis for teaching

The Unit 8 from "Go for it!" Book 4 (published by People's Education Press for the English teaching in junior high school) was selected for the analysis, appraisal and possible betterment.

The unit, themed around literature and music, fits the broader categories of 'Humans and Themselves' and 'Humans and Society.' Section A focuses on literature, using classics like 'Little Women' and 'Oliver Twist' to engage students in English language and culture through various activities. The teaching challenge lies in grasping the usage of "already" and "yet" in the present perfect tense.

Section B, themed on music, reinforces understanding of the present perfect tense and involves activities related to American country music, presenting a challenge in familiarizing students with this cultural context. Teachers are encouraged to provide relevant cultural background and potentially use music videos to enhance learning.

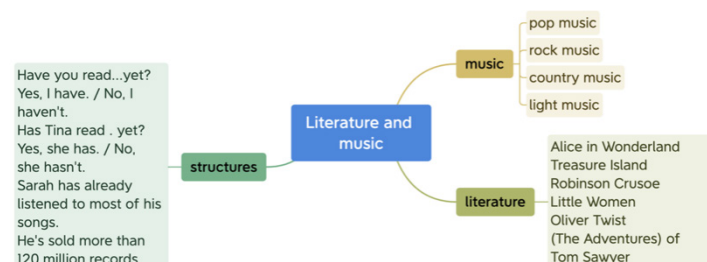

Figure 1: the structure analysis of Unit 8, Book4



Overall, this unit, abundant in foreign cultural discourse, offers a valuable platform for enhancing students' critical thinking and cultural awareness through debates and discussions. Teachers must address the unit's Western-centric content by providing context and analyzing cultural themes for alignment with Chinese social values. This process involves promoting compatible concepts and encouraging students to critically discern and exclude misaligned elements, thereby cultivating critical analytical skills.

### 3.2 The activity-centric improvement: Section A. 3a-3c. reading

#### 3.2.1 The textual background

Section A. 3a-3c of the unit, featuring an abridged version of "Robinson Crusoe," depicts his challenges, achievements, and interaction with Friday, portraying Robinson with self-reliance akin to monarchical sovereignty. This portrayal, reinforced by illustrations, suggests a colonial master-servant dynamic. Educators are encouraged to critically assess the narrative's underlying attitudes and cultural ideologies, with a focus on the subtleties of implicit colonialism inherent in some aggressive Western culture.

#### 3.2.2 The improvements from activity-based approach

To enhance this part, an activity-based approach placing students at the center of learning with authentic materials for deeper comprehension is recommended. This includes facilitating discussions that probe deeper into the narrative and its underlying themes.

Activity 1: Q: What do you think of Robinson's life on the island? Do you think it is terrible?

Educators can boost student engagement and critical thinking by using questions for genuine responses and fostering diverse interpretations, including original literary excerpts. Analyzing instances like Robinson's reaction to footprints in texts can deepen analysis and affirm student perspectives.

Additional discourse 1: ↩

*IT HAPPENED one day about noon, going towards my boat, I was exceedingly surprised with the print of a man's naked foot on the shore, which was very plain to be seen in the sand. I stood like one thunderstruck, or as if I had seen an apparition; I listened, I looked round me, I could hear nothing, nor see anything; I went up to a rising ground to look farther; I went up the shore and down the shore, but it was all one, I could see no other impression but that one; I went to it again to see if there were any... ↩*

Activity 2: Then I begin the teaching of the second paragraph. The first activity is to look for some basic information by filling the information chart about Friday.

<p>The information about "Friday"</p> <p>1.He got this name because he was saved _____ .</p> <p>2.The cannibals have _____ one of his friends.</p> <p>3.He is _____ and he has already _____ some English.</p>
--

After the task, the researcher will offer an activity that will inspire the students to think about the invisible but existent culture pattern.

Activity 3: Discuss with your classmates: what does the last sentence imply (He is smart and I have already taught him some English.)?

Additional discourse 2: ↩

*At last he lays his head flat upon the ground, close to my foot, and sets my other foot upon his head, as he had done before; and after this, made all the signs to me of subjection, servitude, and submission imaginable, to let me know how he would serve me as long as he lived. ↩*



If students have problems venturing out the answers I desire. I can provide them with another authentic discourse from the original literature book.

The added discourse effectively mirrors the accompanying illustration on textbook, aiding students in interpreting deeper meanings in the text. This approach facilitates a critical examination of colonialism and racism,

themes prevalent in “Robinson Crusoe.” As an educator with a Chinese perspective, it becomes natural to highlight these controversial aspects, enabling students to recognize the portrayal of colonization and racism, and understand their status as cultural taboos in the contemporary global context.

#### 4. Implication for teaching

Contemporary junior high school instructional materials need realignment with the New Standards, focusing on unit-based integrated instruction and activity-centered approaches. This realignment involves prioritizing literacy goals, thematically centered teaching, and critical analysis of texts, integrating cognitive and experiential learning for comprehensive unit plans that enhance students’ understanding and competencies. English education should emphasize active student participation in language learning through thematic acquisition, knowledge development, and problem-solving, thereby enriching language skills, cognitive abilities, and cultural awareness. Overall, English education should align with modern societal and educational needs, cultivating individuals contributing to China’s development and renewal.

#### References

- [1] Cunningsworth, A. 1995. *Choosing Your Coursebook* [M]. Oxford: Macmillan Heinemann.
- [2] Tomlinson, B. 1998. *Material Development in Language Teaching* [M]. UK: Cambridge University Press.
- [3] Cheng Xiaotang. 2002. *Analysis and Design of English Teaching Materials* [M]. Beijing: Foreign Language Teaching and Research Press, 52-64.
- [4] Hu Zhuanglin. 1995. Improving the Scientific Nature of Textbook Evaluation [J]. *Foreign Language World*, (1).
- [5] Ministry of Education. 2018. *English Curriculum Standards for Senior High Schools (2017 Edition)* [M]. Beijing: People’s Education Press.
- [6] Ministry of Education. 2022. *English Curriculum Standards for Compulsory Education (2022 Edition)* [M]. Beijing: Beijing Normal University Press.
- [7] Mei Deming, Wang Qiang. 2018. *What to Change? How to Teach? How to Test? Analysis of New High School English Curriculum Standards* [M]. Beijing: Foreign Language Teaching and Research Press.
- [8] Zhang Jinxiu. 2019. Secondary School English Unit Teaching Strategies under the Guidance of Thematic Significance Exploration [J]. *Foreign Language Teaching in Schools (Secondary School Edition)*, (7): 1-6.
- [9] Zhang Linlin. 2019. English Reading Teaching Design Based on Thematic Significance Exploration [J]. *Foreign Language Teaching in Schools (Secondary School Edition)*, (8): 37-42.

Author’s Biography: Chai Chunyi (born in April 1988), male, Han nationality, from Kaiyuan, Yunnan. Currently a graduate student at the School of Foreign Languages, Yunnan Normal University, his research focus is on English teaching in academic subjects.

# A study on cross-cultural adaptation of Indian students in Changsha

Yuyan Qiu

Primary Education College, Changsha Normal University, Changsha 410100, China.

---

**Abstract:** Taking the Indian students in Changsha Medical University as an example, this paper makes a quantitative study on the cross-cultural adaptation of Indian students from four aspects: the basic information of Indian students, the adaptation of Huxiang cultural life, the physical and mental adaptation, and the cultural differences. And then puts forward the corresponding strategies. It is found that the overall level of cross-cultural adaptation of Indian students in Changsha is good, and there is a correlation among Huxiang cultural life adaptation, physical and mental adaptation and cultural differences.

**Keywords:** Indian students; Cross-cultural adaptation

---

In recent years, with the increasing international influence of the Hunan region, especially the provincial capital city of Changsha, more and more foreigners have chosen to study in Changsha. As a country along the “the Belt and Road”, India and China have increasingly deepened cultural, economic, academic and other exchanges. Studying the cross-cultural adaptation ability of Indian international students to the culture of Hunan region is of great significance for strengthening the cultural construction of Changsha city, providing management services for studying abroad in universities, and promoting cultural exchanges between China and foreign countries. At present, Chinese scholars have conducted some research on the cross-cultural adaptation of international students studying in China, but few have separately listed Indian students as survey subjects, and there is almost no literature specifically studying the cross-cultural adaptation of Indian students studying in Changsha. This study selected universities with a high concentration of Indian international students for investigation, conducted quantitative analysis, and proposed corresponding suggestions.

## 1. Explanation of investigation situation

### 1.1 Basic information of survey subjects

The survey subjects of this article are 30 Indian international students from grades 1-3 of MBBS major at Changsha Medical College. A questionnaire sampling survey method was adopted, and a total of 20 questionnaires were distributed and 16 questionnaires were collected, with a response rate of 80%. Among them, 9 were male students, accounting for 56%, and 7 were female students, accounting for 44%. In addition, 10 Indian international students were randomly selected for semi-structured interviews to gain a deeper understanding and record their adaptation to learning, life, and culture.

### 1.2 Questionnaire Design

The problem design of this survey research is divided into four parts: first, basic demographic information; The second is a survey on the adaptability of Hunan cultural life, with a total of 25 questions; The third is a personal physical and mental adaptability survey, with a total of 17 questions; The fourth is about the scoring of cultural distance, where the survey subjects compare the cultural expressions in eight aspects with the degree of similarity in their own country. The scale uses the Likert Five Scale to indicate different levels of difficulty.

After the questionnaire was collected, data was entered and analyzed using Excel and SPSS software. Cronbach from the survey questionnaire  $\alpha$  The reliability coefficient value is 0.945, indicating that the reliability quality of the research data is very high.

## **2. Analysis of the Current Situation of Cross Cultural Adaptation among Indian International Students in Changsha**

### **2.1 Adaptation to Hunan Cultural Life**

According to statistics, it reflects the adaptation of Indian students studying abroad in Changsha to Hunan culture and life. The higher the average score, the greater the difficulty level. The average score of the scale is 2.72, indicating that in terms of adapting to Hunan culture and life, Indian international students generally believe that the difficulty level is average, and although there are some problems in social life, they can still adapt. The adaptation level of Indian international students in the three items of “making friends in China”, “being able to express themselves clearly”, and “being able to understand jokes or humorous language” is higher than the average, indicating that they have some difficulties in language communication. In the interview, we learned that Indian international students are able to gradually understand and accept Chinese lifestyle and social culture, and can also view problems better with Chinese thinking and local perspectives. However, there are many difficulties in understanding in deep communication and exchange.

The degree of integration of international students into local culture varies from person to person. The higher the language proficiency of Indian international students, the more they can make full use of their extracurricular time to continuously improve their Chinese listening, speaking, and cross-cultural communication skills. However, students with lower Chinese proficiency often tend to form groups, and due to differences in cultural customs and lifestyle habits, as well as difficulties in language communication, they are more inclined to communicate with their own people, Limit your circle of friends to the circle of international students. In addition, people in the Xiang dialect area have a heavy accent when speaking, and their oral expression and content deviate from standard Mandarin, with obvious regional characteristics. Especially, the use of the erhua sound in spoken language is not common, “l/n” is not distinguished, flat and raised tongue sounds are confused, and the distinction between front and back nasal sounds is unclear. There are differences in language knowledge learned by international students in Chinese classrooms, which is beneficial for Indian students studying Chinese in China, Undoubtedly, it has increased the difficulty.

### **2.2 Physical and mental adaptation**

We have evaluated the physical and mental adaptation of Indian students studying in China, and the higher the score, the higher the frequency. Table 1 shows a positive overall average score of 1.42, indicating that Indian international students have better physical and mental adaptation. The score for the item “I eat as much as I used to” is relatively low. In in-depth interviews, we found that Indian international students who have just arrived in China may experience a phenomenon of “not adapting to the local conditions”, but over time, there is a gradual improvement trend. For example, in terms of diet, Indian cuisine is completely different from Chinese cuisine. Indian cuisine has rich seasonings and is accustomed to the “hand grabbed rice” eating style, while Hunan cuisine is oily, spicy, and has a strong taste. Indian students who believe in Hinduism or Islam find it difficult to adapt to the common Chinese way of eating beef and pork, so the vast majority of Indian international students choose to cook in their dormitories and occasionally go to school cafeterias for meals during busy classes.

Most Indian international students are satisfied with the cultural life in Hunan, and their overall mentality is healthy and positive. Occasionally, they may have emotional and psychological problems, but they can self guide and resolve them through sharing with friends and family. In the interview, it was found that some Indian international students with low Chinese language proficiency have some problems in terms of physical and mental adaptation. They have no learning goals, a single lifestyle, and are in a state of confusion about the future. They also have some discomfort adapting to living in Changsha.

### **2.3 Related analysis**

Through the investigation of the adaptability of Indian international students to Hunan cultural life, physical and mental adaptation, and the correlation analysis with cultural distance (Table 2), it can be seen that the correlation coefficient between cultural distance and socio-cultural adaptation is 0.566, and it shows a significant positive correlation at the 0.05 level, indicating a significant positive correlation between cultural distance and socio-cultural adaptation; The correlation coefficient between cultural distance and physical and mental adaptation is

0.654, and it shows a significant positive correlation at the 0.01 level, indicating a significant positive correlation between cultural distance and physical and mental adaptation.

### 3. Inspiration and suggestions

The survey results show that the overall cross-cultural adaptation of Indian international students in Changsha is good. In response to some of the issues raised in the survey, we can adopt proactive strategies to better enhance the cross-cultural adaptation ability of Indian international students in Changsha.

(1) Chinese language teaching should attach importance to the charm of regional culture and achieve the connotative development of Chinese cultural curriculum. To optimize the cultural promotion content of education for international students studying in China, Mr. Zhao Jinming once proposed to develop “local Chinese language textbooks with regional characteristics”. Therefore, we should moderately increase the content and dissemination of Hunan culture, fully demonstrate the distinctive Hunan cultural connotations, inherit and promote excellent traditional Chinese culture, and enable international students to fully integrate into local culture and enhance their cross-cultural communication abilities. In addition, we should improve the practicality and fun of Chinese classroom teaching. Teachers can appropriately demonstrate the similarities and differences between Hunan dialect and Mandarin in teaching, so that international students can feel the language connotations, expression styles, and cultural characteristics of different places, and improve their language proficiency in practical life.

(2) Promote the construction of a community of Chinese and foreign students, and form an integrated management and service system. Expanding the social circle of international students, eliminating barriers between Chinese and foreign students, breaking down institutional barriers, it is recommended to implement integrated management for Chinese and foreign students, avoid differential treatment, actively build international student associations, and give international students more rights and opportunities to fully participate in school construction. Actively carry out various cultural and sports activities and social practices that involve both Chinese and foreign students. Specifically, universities can organize volunteer service activities such as “going to the countryside” and “teaching support” to cultivate the practical ability, teamwork spirit, and communication and exchange abilities of international students; Organize cultural salons, Chinese and English speech competitions, recitation of classic poems, Chinese corners, and other activities to enhance students’ cross-cultural communication skills; Strengthen the intensity and connotation of Chinese cultural practice inspection activities, attract international students to have a deeper understanding of Chinese culture, and cultivate their Chinese sentiment; Encourage international students to actively participate in cultural performances, sports events, marathons, basketball, football and other major competitions, enhance friendship between Chinese and foreign students, and promote cultural integration.

### References

- [1] Huang Fangfang The Application of Hunan Culture in Teaching Chinese as a Foreign Language [J] College Chinese Language Construction, 2019 (12).
- [2] Jiang Jiabin, Wang Yanhua A Study on Cross cultural Adaptation of International Students in Changsha Universities [J] Introduction to News Research, 2019.
- [3] Ma Xingxiang, Yin Xinqi A survey and countermeasures on the cross-cultural adaptation of African international students studying in China: A case study of a certain university Journal of Hebei University of Economics and Trade (Comprehensive Edition), 2019.

# Research on the Project Management of Innovation and Entrepreneurship Training Program for College Students

Pingan Gao

Changsha Normal University, Changsha 410100, China.

---

**Abstract:** The college student innovation and entrepreneurship training program is an important way for universities to cultivate students' innovation literacy and improve their innovation ability, and is an important way to cultivate innovative talents. The college student innovation and entrepreneurship training program requires a student-centered approach, integrating professional knowledge and innovation abilities through students' divergent thinking patterns, actively carrying out innovation and entrepreneurship training program projects, so that students can continuously improve their practical abilities, enrich their innovation and entrepreneurship experience, and become innovative talents in the country during the project.

**Keywords:** College students; Innovation and entrepreneurship; Planned project; Reflection on research

---

College students are the main force in building an innovative country in our country. Because college students have a certain level of cultural literacy and knowledge, guiding them to actively participate in innovation and entrepreneurship training programs is conducive to continuously tapping into their innovative practical potential, improving their innovation ability, broadening their thinking, and laying a certain foundation for the country's scientific and technological development and economic development. Universities actively carry out innovation and entrepreneurship training programs for college students, Conduct in-depth research on issues and measures in project management to provide certain guarantees for project implementation.

## 1. The Current Situation of Project Management in the Innovation and Entrepreneurship Training Program for College Students

### 1.1 Students lack a research attitude

In the process of planning innovation and entrepreneurship projects for college students, due to the fact that students are only new to the project, they place too much emphasis on the results while participating in the project, but are not clear about the details of the project process, which can easily lead to a "tiger start snake tail" process. In the process of managing innovation and entrepreneurship training programs for college students, students tend to focus only on seeking the actual results of the project, while neglecting the process of the project. In the "conclusion" stage of the project, there may be discrepancies between theory and practice. Therefore, in the implementation of the project for college students, universities should enhance their regulatory capabilities to ensure the smooth development and completion of the student project.

### 1.2 Project planning detached from actual development

Due to the fact that college students have reached adulthood and possess a strong sense of independence and innovative thinking, it is often easy for them to pursue innovative research projects in the project management center of the College Student Innovation and Entrepreneurship Training Program, hoping to complete the projects in a short period of time. This can lead to a mismatch between project theory and practice, and the inability of project research to last, resulting in the project not being able to smoothly become an industry.

## 2. Principles for the Implementation of the College Student Innovation and Entrepreneurship Training Program

### 2.1 Emphasize the cultivation of scientific research abilities

The innovation and entrepreneurship project for college students is an important project aimed at strengthening the training of students'

innovation and entrepreneurship abilities and enhancing their innovation abilities. It aims to cultivate high-level innovative talents in the country. The college student innovation and entrepreneurship training project is designed and planned independently by students, and team members are assigned tasks during the project implementation process. The overall planning of the project is completed by students in collaboration, enhancing their innovation and practical abilities, and promoting students to build their own innovative thinking during the process of reviewing materials and writing project topics. During the process of project investigation and visits, students conduct on-site inspections and records of multiple enterprises, which not only enriches their social knowledge and experience, broadens their horizons, but also enhances their analytical abilities, promoting them to become outstanding talents for sustainable development.

## **2.2 Enhance the professional competence of senior mentors**

The innovation and entrepreneurship training program for college students usually consists of a team composed of students themselves, guided by mentors, who independently complete the design, research, implementation, and other aspects of innovative projects, and carry out entrepreneurial practice activities. In the process of project implementation, the attitude of teachers has a significant impact on students. Therefore, when guiding students in entrepreneurial practice activities, teachers should pay attention to their own level of participation, plan a certain amount of time to guide students in project implementation, and provide guidance and planning from various processes such as project planning and report writing to assist students in successfully completing training projects. In the process of guiding students to carry out projects, mentors should follow the students' thinking, guide them to propose various solutions and plans, fully tap into their innovative abilities and spirit, and promote the smooth implementation and development of their innovation and entrepreneurship projects.

## **3. Effective Strategies in Project Management of College Student Innovation and Entrepreneurship Training Program**

### **3.1 Strengthen project management and supervision**

The innovation and entrepreneurship projects for college students involve multiple stages, including innovative research project design, research condition preparation and implementation, research report writing, and research achievement exchange. Only by fully preparing the details of each stage can students truly ensure the smooth completion of the innovation and entrepreneurship project objectives. The management during project implementation is the leading link in ensuring the smooth progress of the project. Therefore, universities should strengthen project management and supervision, cultivate students' rigorous scientific attitude and awareness, supervise students to establish project weekly reports, summarize and reflect, and regularly release project implementation progress, in order to ensure the implementation and progress of the project through multiple means.

### **3.2 Project management informatization**

In the process of managing innovation and entrepreneurship projects for college students, Internet technology in the context of the information age should be utilized to carry out information-based project management processes, establish project informatization, and allow computer systems to automatically review and supervise projects. This not only reduces the workload of management personnel, but also improves detection efforts and management efficiency. At the same time, the computer system should be equipped with a function for automatically pushing project progress. It is beneficial for teachers and students to jointly pay attention to the progress of the project, break the limitations of space and time during the implementation process, encourage students to freely allocate project work time, and successfully complete project work.

### **3.3 Establish a project faculty and student team**

Universities should establish a dedicated team for college student entrepreneurship and innovation projects. Before students engage in practical activities related to college student innovation and entrepreneurship projects, the school should conduct knowledge lectures and use past innovation and entrepreneurship project cases to popularize knowledge and experience among students. This is beneficial for students to

use the team's knowledge and experience to manage project processes and strengthen the professionalism of innovation and entrepreneurship projects. At the same time, universities should strengthen the cohesion of the teacher-student team, guided by mentors and led by students, and work together to ensure the smooth implementation of innovation and entrepreneurship projects for college students.

## **Conclusion**

In summary, the smooth implementation of the College Student Innovation and Entrepreneurship Training Program is beneficial for universities to innovate traditional educational concepts, truly implement the teaching philosophy of national quality education, cultivate students' innovative and practical abilities, enrich their entrepreneurial experience, enable students to continuously improve themselves, broaden their learning horizons, and truly contribute to the country's scientific and technological innovation and career development in the process of completing the project.

## **References**

[1] Qing Sihan, Xiao Shiwei, Wen Jinqiong. Reflections on Project Management of Innovation and Entrepreneurship Training Programs for College Students [J]. Western Quality Education, 2020,6 (01): 159-160.

[2] Shen Li. The Application of Project Management in the Innovation and Entrepreneurship Training Program for College Students [J]. Reporter Observation, 2018 (23): 31.



# On the Strategies of Student Management under the Guidance of High Quality Talent Training in Universities

Huiming Li

Harbin University of Commerce, Harbin 150028, China.

---

**Abstract:** As the cradle of high-quality talent cultivation, university administrators need to attach importance to student management work, and take talent cultivation as the starting point, formulate reasonable and scientific strategies for student management work, continuously improve the implementation quality of student management work, which plays a very important role in promoting the development of university education. This article provides a detailed analysis of the student management strategies under the guidance of high-quality talent cultivation in universities.

**Keywords:** Universities; High quality; Talent cultivation; Student management

---

## 1. The importance of student management under the guidance of high-quality talent cultivation in universities

(1) It helps to improve teaching quality. By strengthening the implementation of student management work, not only can it promote the comprehensive development of students, but it can also greatly improve the quality of higher education and teaching, further enhance students' self-discipline, regulate their behavior effectively, create a good learning environment, and stimulate their motivation and interest in learning. (2) Helps to enhance students' overall quality. By implementing high-quality student management work, students can pay more attention to academic performance and their overall quality will be comprehensively improved. In addition, universities can actively organize clubs or extracurricular activities to stimulate students' personal interests, teamwork spirit, and social adaptability, helping them comprehensively improve their personal comprehensive qualities. (3) Standardize student behavior habits. Continuously improving the level of student management in universities can help them develop good personal behavior habits and establish correct values, outlook on life, and world-view. In addition, universities can help students form a good sense of citizenship and enhance their sense of social responsibility by carrying out moral education, health education, and legal education activities. (4) Promote the personal development of students. By strengthening student management, individual needs of students can be met, and personalized tutoring can be used to tap into their potential and advantages, helping them better adapt to the needs of social development. (5) Create a safe and orderly campus environment. Maintaining campus order and safety is an important aspect of student management, ensuring that students can complete the entire university learning task within a safe campus. In summary, university administrators should attach importance to student management work and actively take measures to improve the level of student management work, which undoubtedly plays a positive role in talent cultivation in universities.

## 2. The connection between high-quality talent cultivation in universities and student management

### 2.1 Existence of consistent entities

Whether it is student management or talent cultivation, the service subjects of the two are consistent. In the process of managing students, universities need to comprehensively implement educational work through education, activities, and other means, with the goal of enhancing the comprehensive abilities of students and ensuring that they can better adapt to society after graduation. For talent cultivation work, it also refers to improving students' professional skills and helping them establish the correct "three views" through teaching activities. In short, student management and talent cultivation have the same main body.

### 2.2 There is a unified goal

Comprehensively improving the comprehensive literacy of college students is not only the goal of talent cultivation, but also the goal of student management. For universities, in the process of cultivating talents, it is not only necessary to participate in teaching work, but also

in student management work. Ultimately, the work goal is to promote the comprehensive development of students. Universities can enrich students' professional knowledge through education and teaching, while also enhancing their moral qualities. In student management work, universities can enhance students' practical abilities through organizing practical operations, solidarity and cooperation activities, which helps to enhance their abilities beyond professional knowledge. In short, organically integrating student management with educational and teaching work can greatly enhance students' comprehensive literacy.

### **2.3 There is a consistent drive**

With the increasing number of college graduates year by year, the employment situation has become very severe. In order to enhance the employment competitiveness of college graduates and alleviate their employment pressure, college administrators not only need to enrich their professional knowledge, but also cultivate their innovative abilities. For student management and educational teaching, both have the same educational motivation, which is to continuously enhance students' professional knowledge and skills, and help them integrate into society more quickly.

## **3. The current situation of student management in universities**

### **3.1 Deviation in management philosophy**

With the increasing emphasis on student management in Chinese universities, student management has shown a diversified development trend in form, resulting in a significant deviation between teaching and student management concepts, making it difficult to quickly achieve the goal of high-quality talent cultivation in universities, and affecting the implementation effect of student management in universities. At the same time, there is a close connection between the education and teaching work in universities and student management work. However, some university administrators believe that student management work is a "non academic" work, often separating student management from education and teaching, resulting in the unmet practical needs of students and affecting the normal development of student management work.

### **3.2 The management content is not rich enough**

For universities, cultivating high-quality talents is an important work goal. With the continuous increase in enrollment, it has brought great challenges to student management work. At present, in addition to dormitory management, some university student management work also needs to actively carry out learning psychological health counseling, graduation counseling, and other work. However, from the perspective of the actual needs of students, a considerable number of universities still face the problem of insufficient content in student management, which makes it difficult for universities to quickly cultivate high-quality talents, ultimately affecting the future employment and personal development of students.

### **3.3 The management system is relatively single**

In the daily management work of some universities, student management and education and teaching are independent of each other, without integrating student management and education and teaching into a whole, resulting in a disconnect between student management and education and teaching work, which affects the effectiveness of cultivating high-quality talents in universities. At the same time, in some universities, student management is mainly the responsibility of counselors. Counselors are not only responsible for employment guidance, mental health education, but also for ideological and moral education and club activities. Due to the uneven professional abilities of counselors and a lack of sufficient time and energy, the implementation effect of student management work is affected.

## **4. Strategies for student management under the guidance of high-quality talent cultivation in universities**

### **4.1 Actively transforming student management concepts**

The specific work strategy is: (1) closely integrate student management with education and teaching work, Simultaneously innovat-

ing student management models, while comprehensively improving students' professional skills, can fully mobilize their learning initiative, stimulate the potential of each student, and enable student management to develop in a personalized direction. (2) Today, with the continuous reform of the higher education system, universities need to actively transform traditional management concepts, pay attention to the personalized and diverse needs of students, and develop targeted implementation plans for student management work, which can help enhance the competitiveness of students in future employment.

#### **4.2 Continuously enriching management content**

(1) In student management work, they should build a technological innovation platform, focus on cultivating students' innovation ability, tap their learning potential, and ensure that each student can feel sufficient fun in learning. Thus, it plays a role in enhancing students' learning initiative. (2) Universities need to build a comprehensive education and training service system. In addition to emphasizing the study of professional courses, they also need to actively organize club activities, technology competitions, and other activities. At the same time, they need to develop targeted learning plans for each student, help them improve their personal comprehensive qualities as soon as possible, and lay a solid foundation for the smooth employment of university students in the future.

#### **4.3 Actively improving and innovating management mechanisms**

In order to better adapt to the demand of society for talent cultivation in universities, university administrators should focus on students, continuously improve the teaching management system by understanding the trend of education reform, and innovate student management work from multiple perspectives and layers. They should continuously summarize and analyze the problems exposed in actual student management work, scientifically optimize the implementation methods of student management work, and accelerate the efficiency of solving practical problems for students. Ensure that students' professional skills can grow rapidly under modern management systems.

#### **4.4 Reasonably constructing and optimizing evaluation methods**

The specific requirements are: (1) Guided by talent cultivation, by understanding the needs of different students, university managers can clarify the individual differences between students. By constructing a personalized evaluation mechanism, students can clarify their own needs and implement personalized training strategies in a targeted manner, which can help them improve their overall personal qualities as soon as possible. (2) Universities need to continuously enrich the content of their evaluation system. In addition to assessing students' professional skills, they also need to evaluate their moral quality, teamwork ability, and innovation ability. The weights of various evaluation indicators should be reasonably determined to ensure that the comprehensive quality of students can be accurately evaluated.

### **5. Conclusion**

In order to comprehensively improve the level of high-quality talent cultivation in Chinese universities, university managers need to take talent cultivation as the starting point of their work, analyze the problems existing in current university student management work, and formulate targeted implementation strategies for student management work, reflecting the central position of students in student management work, and ultimately achieving the goal of improving the quality of university student management work.

### **References**

- [1] Zhu Qinhui. Student management strategies under the guidance of high-quality talent cultivation [J]. Talent Resource Development, 2023, (09): 75-77.
- [2] Lin Shunli. Seizing the "Window Period" to Promote High Quality Employment through High Quality Talent Training [J]. China Social Work, 2023, (01): 15.

# Through analysis of historical data to reappear the last moment of Zhiyuan

Ziming Pan

Beijing No. 5 Middle School, Beijing 100102, China.

---

**Abstract:** The Sino-Japanese War of 1894-1895 was an important turning point in modern Chinese history. The defeat of the War aggravated the crisis of the Chinese nation and greatly deepened the degree of semi-colonization of China. The Battle of yellow sea was an important part of the Sino-Japanese War, in which the Beiyang fleet suffered heavy losses and completely surrendered the control of the Yellow Sea. However, in the course of the naval battle, the indomitable spirit of the officers and soldiers of the Beiyang fleet and their struggle with the enemy to the end were remembered by the world. One of the most familiar action among there struggle is the Zhiyuan under the leadership of Deng Shichang to sink the Japanese flagship “Yoshino”. How Zhiyuan acts in its final moments before its sunk has been the subject of academic attention and public discussion. With the first discovery of the shipwreck site of Zhiyuan in Dandong, Liaoning Province in 2015, the development of underwater archaeological technology, and the further in-depth archaeological work on the remains of Zhiyuan, more and more detailed information about the ship before its sunk process has been disclosed. This paper tries to reconstruct the whole process of the heroic martyrdom of the officers and men of Zhiyuan in the Battle of yellow sea through the empirical evidence of historical materials.

**Keywords:** Historical evidence; Zhiyuan ship; Yellow Sea naval battle

---

## 1. The main disputes about the sunk of Zhiyuan

### 1.1 The reason of Zhiyuan’s sunk

Since the ship Zhiyuan sank in the naval battle of the Yellow Sea, the reason for the sinking of the ship Zhiyuan has aroused the attention of the academic circles and the public discussion. Among them, the earliest record was Yao Xiguang’s “Chronicle of Oriental War”. It was claimed that the Zhiyuan was sunk by a torpedo. The Chronicle of Oriental War is a military monograph written by Yao’s own experience, his collection of official documents, telegrams, private letters and other information he had gained after the First Sino-Japanese War. The book is an important reference material for the early study of the history of the Sino-Japanese War. In the book, he wrote: “The Zhiyuan was torpedoed, the machine boiler burst, and the ship leaned left then sank instantly.” He thought the zhiyuan was sunk by the Nakshino’s torpedo. This earliest judgment about the sinking reason of zhiyuan has had a great influence on the later generations. The scene that Zhiyuan was torpedoed has even become a classic of the relevant literary works led by the classical film “Sino-Japanese”. In addition, as the educational edition of the third grade Chinese textbook unit 3 lesson 5 “Patriotic general Deng Shichang” claimed: “in the” Zhiyuan “is about to hit the enemy ship, unfortunately was hit by a torpedo, immediately the whole ship exploded on fire, soon sank.” Some primary and secondary school textbooks in the Yellow Sea battle also insist that the Zhiyuan was sunk by torpedo.

It has been the mainstream view that Zhiyuan was sunk by the Nakshino’s torpedo for a long time. But what evidence supply to Yao Xiguang’s judgment? In his work “Examination of the Reasons for the Sinking of” Zhiyuan “, Jiang Feng wrote:” Yao’s record of the sinking of “Zhiyuan” was written based on Li Hongzhang’s memorial to the throne at that time. However, there is obviously a big gap between Ding Ruchang’s battle report to Li Hongzhang after the Yellow Sea battle and the actual battle situation. He had a obvious lies in his post-war reports. In addition, Ding Ruchang was seriously wounded at that time, there was a certain distance between Dingyuan and Zhenyuan, and at that time, many ships were shot and caught fire, and smoke was everywhere. In my opinion, the possibility that Ding Ruchang truly saw with his own eyes of enemy’s torpedo hit Zhiyuan is low, so the credibility of his battle report is low. Thus, I consulted other relevant historical materials on this issue. Another opinion about the cause of the sinking of Zhiyuan is that the sinking by the Japanese’s shipboard artillery has been widely recognized in recent years. The earliest assertion of the theory comes from the 1895 edition of the Platsey Naval Yearbook, The book described: “The first guerrilla of Japanese fleet saw the” Zhiyuan “ ship marched forward, then with a group of guns in Zhiyuan, repeat-

edly bombardment. Several grenades hit the Zhiyuan waterline at the same time, causing a torpedo explosion inside the sideside torpedo pipe and leaning starboard.” With the discovery of new historical materials, it was gradually recognized and accepted. One of the most representative is the disclosed Japanese naval operations report that the Japanese army did not use the torpedo in the battle in the Yellow Sea.

Earlier this year, the report, jointly compiled by the Archaeological Research Center of the State Administration of Cultural Heritage and the Liaoning Provincial Institute of Cultural Relics and Archaeology, was published. The report said: “ The well-preserved torpedo fuzes and some intact ammunition found near the bow of Zhiyuan indicate that there was no direct sinking by torpedoes in the torpedo capsule.”- This assertion, based on the latest archaeological findings, can fundamentally refute the idea that Zhiyuan was sunk by the hitting of torpedo.

To sum up, the reason for the sinking of Zhiyuan is the fire after the gun, water, and the final sinking after the hull tilt.

## 1.2 Whether the impact object of the Zhiyuan was Yoshino

Similar to the sinking of the Zhiyuan, whether the impact object of the ship was Yoshino is also a major issue that has aroused academic attention and public discussion since the silence of the ship. In the general understanding, the impact object of Zhiyuan is Yoshino. The earliest source of this cognition is also Yao Xiguang’s “Chronicle of Oriental War”. In the book, he wrote: “ Zhiyuan medicine shot out, suitable for the Japanese Japanese value. Tube with Deng Shichang... that the Japanese ships rely on Yoshino, if the sinking is a ship, then our army can gather things (accomplish), then drum express, conflict to Yoshino.” Like Zhiyuan, which sank by a medium torpedo, this assertion became a mainstream view. For instance, the people’s high school history compulsory a project two second lesson” the Chinese military and civilians struggle to safeguard national sovereignty “in the zhiyuan ship hit the heroic deeds of the ship wrote:” zhiyuan in the ship after gun tilt, ammunition, tube with Deng Shichang ordered full horsepower to the ship “yoshino” hit, unfortunately was hit by shells, the ship soldiers heroic martyrs. This can see the profound influence of this judgment on the later generations. In view of this problem, another argument is that the impact of the Japanese ship for the magifen, an American employee of Zhenyuan, published in the Century Magazine in 1895. He wrote: “ The ship’s men, determined to die with the enemy and charged against one of the enemy’s biggest ships, preparing for impact.” The displacement of 4,278 tons is slightly greater than Yoshino’s 4,150 tons. Therefore, according to Majffin’s description, the Japanese ship Zhiyuan tried to hit should be Matsushima, not Yoshino. The author has consulted the relevant historical materials, and think that the following historical materials can support this point of view. First of all, in the Yellow Sea battle, the formation of the Beiyang Fleet is “split geese”, Zhiyuan is on the left wing of this burst. The Japanese joint fleet is divided into its own team and the first guerrilla, among which the flagship of the team is Matsushima and the first guerrilla flagship is Yoshino. The Beiyang fleet was attacked through repeated rotary movements. According to the 1:1 deduction of Mr.Chen Yue, President of the History of the Chinese Navy, the flagship of the team moved to the front of the Beiyang fleet at about 15:25 before the sunk.

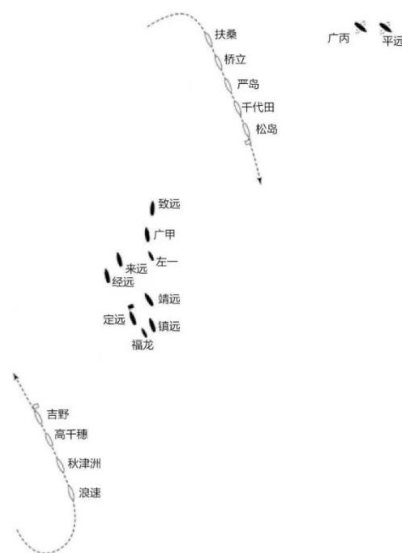

In other words, to hit the Yoshino, Zhiyuan must turn at least greater than 150 degrees. That is almost impossible for the Zhiyuan, which has already been shot and caught fire. Secondly, the speeds of Zhiyuan, Yoshino and Matsushima are 18 knots, 23 knots and 16.5 knots respectively. Therefore, to collide Matsushima is a more realistic choice. In addition, according to the news picture titled “The sinking of the Chinese warship” Zhiyuan “ published in Illustrated London News on November 24,1894, the picture is heavily tilted and about to sink, and the flagship Matsushima with the flag of the Japanese Joint Fleet.

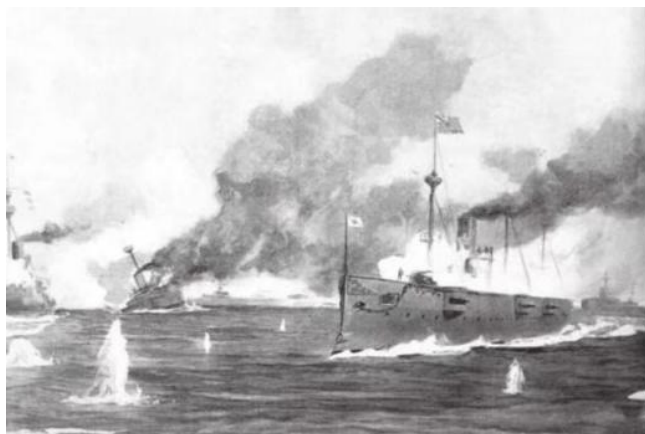

In conclusion, the target of the collision is the Matsushima, the flagship of the Japanese joint Fleet, rather than the flagship of the first guerrilla.

## 2. The revelation of the last moments before Zhiyuan’s martyrdom was restored through historical evidence

Through the above comparative study of historical data on the process of Zhiyuan ship’s martyrdom, I got the following enlightenment: First of all, when studying any historical event, we should always follow the principle of “independent evidence” and “multiple mutual evidence”, and do not have subjective preconceptions. The mainstream understanding of the two controversies in the course of Zhiyuan’s martyrdom comes from Yao Xiguang’s Chronicle of the Eastern War. Indeed, as the primary research data of the Sino-Japanese War and the Yellow Sea Battle, it has its unique advantages. But it would be a bit biased to judge from his own words. Secondly, in the study of any historical event, the selected sources should be carefully investigated to judge their authenticity. For example, Yao Xiguang’s Chronicle of the Eastern War has a high credibility as a military monograph, but after careful examination, it is found that the description of the Yellow Sea Battle in the book is based on Ding Ruchang’s battle report. However, Ding Ruchang was seriously wounded at the beginning of the Yellow Sea Battle, coupled with the prevailing smoke and the nature of the war report, so the book’s description of the Yellow Sea battle is not reliable. Finally, the spirit of daring to question should be developed in the study of any historical event. For example, the Zhiyuan ship was torpedoed and sank, and the Zhiyuan ship tried to hit the Yoshino ship and other arguments have become mainstream for a long time, and even have been written into the textbooks of primary and secondary school students. However, it is precisely because of the desire of countless historians to restore the historical truth, they carefully collate historical materials, look for illogical contradictions, and develop the spirit of questioning. Only now has a more detailed and detailed study of the process before the death of the Zhiyuan ship. As Marx said, “The development of things is a spiral,” and the truth of history may be late, but never absent.

## References

- [1] Qi Qizhang. The History of the First Sino-Japanese War [M]. Shanghai: Shanghai People’s Publishing House, 2014.459-463.
- [2] Yao Xiguang and Li Jikui. Oriental Military Chronicle [M]. Beijing: Zhonghua Book Company, 2010.
- [3] Jiang Feng. “Zhiyuan” ship sinking reason test [J]. The Lantai World, 2010. Issue 07:54-55.
- [4] Chen Yue. The Armageddon in the Yellow Sea [M]. Beijing: Taiwan Strait Press, 2018.668.
- [5] The sinking of the Chinese warship Zhiyuan, a news painting [J]. The Illustrated News of London, 24 November 1894.

# A Study on Digital Literacy of College English Teachers in Digital Age

Hui Guan, Wenping Li

Qingdao City University, Qingdao 266106, China.

---

**Abstract:** With the rapid development and popularization of information technology, the digital age has arrived. China has attached great importance to the development of digital education. The Report of the Communist Party's 20th National Congress and the standards of Digital Literacy for Teachers provides policy and theory support for the study. With the integration of information technology and college English teaching, college English teaching has gradually emerged with new connotations, new characteristics and new changes. As the key force for the transformation of education digitization, college English teachers' improvement of digital literacy is increasingly critical. This essay aims to explore the connotation and frame of core digital literacy of college English teachers, so as to clarify the development direction of college English teachers' digital literacy, and promote the construction and development of English teachers in digital age.

**Keywords:** Digital age; College English teachers; Digital literacy

---

## 1. Introduction

In digital age, digital technology has been widely used in various fields, impacting the traditional education ecology and the digital transformation of education has begun (Yang, 2021). European Union, UNESCO, the United States, UK, China and other major world organizations and countries give great priority to digital transformation of education and have issued relevant policies and documents to promote the digital transformation of education. China's "14th Five-Year Plan" clearly states that it is necessary to accelerate digital development, build a digital China, embrace the digital era, activate the potential of data elements, and drive the transformation of production methods, lifestyles and governance methods with digital transformation. The Report of the Communist Party's 20th National Congress also clearly requires "promoting the digitization of education", which sets the tone for the continuous development of the digitization construction in the field of education in China.

China is a big country in foreign language education, with a large group of foreign language learners and teachers. In digital age, the digital literacy of foreign language teachers is closely related to the efficiency and quality of foreign language teaching, and further relates to the level of China's international communication capacity construction. With the integration of information technology and college English teaching, college English teaching has gradually revealed new connotations, new characteristics and new changes. Therefore, college English teachers should play a great role and actively change the teaching mode, improve digital literacy and integrate high-quality teaching resources.

## 2. Analysis of the digital literacy of teachers

### 2.1 Foreign research on the digital literacy of teachers

In the 1990s, with the rapid and continuous development of digital technology, the ability to apply digital technology to complete tasks and solve problems became the basic literacy requirement. Around this new literacy requirement, Gilster (1997) proposed "Digital Literacy" for the first time in 1997.

After extensive discussion and research, the connotation of digital literacy has been rapidly developed and deepened. In order to clarify the development direction of teachers' digital literacy, some countries and international research institutions have issued relevant research reports or frameworks. For example, in 2010, UK Future Lab released the report "Digital literacy across the curriculum" and held that the connotation of teachers' literacy should be closely combined with the teaching needs and practice of the subject (Jones, R. 2016). In 2017, European Union published the Digital Competence Frame for European Educators, empowering learning from professional engagement, digital resources, teaching and learning, assessment and stipulating the basic digital literacy of teachers and the specific digital literacy in subject

teaching (Jurida, S. H. et al. 2016). In 2019, UK released the Digital Teaching Profession Frame, composed of subject teaching, evaluation, accessibility and inclusion, self-development. In 2022, the University of Cambridge made a digital literacy primer for teachers and education administrators, stating that digital literacy consists of a range of skills, mainly including search and creating digital content with tools, solving problems and innovation, online sharing and interaction, online safety and health.

To sum up, foreign institutions or academics agree that teachers' digital literacy mainly includes digital thinking, digital skills and digital teaching competence, digital ethics and security, but the differences of characteristics and goals in regional education development contribute to different interpretation of the connotation of teachers' digital literacy.

## **2.2 Domestic research on the digital literacy of English teachers**

As the process of integrating technology into education is constantly changing, our country, the requirements and priorities for teachers in different periods vary a lot, which provides reference for explicit connotation of Chinese teachers' digital literacy.

In 2014, the Standards for Information Technology Application Ability of Primary and Secondary School Teachers (Trial) guides teachers' promotion and development. Therefore, at that time information technology application skills for teachers are the main requirements and focus, including the ability to apply information technology to optimize classroom teaching and change learning styles.

With the surge of innovation in education and teaching supported by information technology, information technology has a fundamental influence on education and teaching and changes the environment, mode, concept and culture of education gradually. To promote teachers to proactively adapt to the changes of the educational system, the Ministry of Education released the "Education Informatization 2.0 Action Plan" in 2018, requiring the transformation of teachers and students' application ability of information technology to their information literacy.

Digital literacy is the extension and change of information literacy in the digital age, and the heterogeneity of the two is mainly reflected in the emphasis on different literacy and skills in different ages. In 2022, the Ministry of Education developed and released the standards of Digital Literacy for Teachers to empower teachers to use digital technologies to optimize, innovate and transform education activity awareness, competence and responsibility, which puts more emphasis on digital literacy. The standard points out teachers' digital literacy refers to the consciousness, ability and responsibility that teachers have in using digital technologies to acquire, process, use, manage and evaluate digital information and resources, discover, analyze, and solve problems related to education, optimize, innovate, and change educational and teaching activities.

## **3. Exploration of the digital literacy of English teachers**

Through the analysis of the digital literacy of teachers and the interpretation of A Guide to College English Teaching (2020) and New English Curriculum Standard, the author tries to explore the core digital literacy of college English teachers. On the basis of the existing digital literacy framework and the reality of college English teaching in China, this author considers that college English teachers' digital literacy should include digital consciousness, digital technology knowledge and skills, digital application, digital social responsibility and professional development.

### **3.1 Digital consciousness**

Digital consciousness refers to the basic consciousness that English teachers should acquire in teaching. To be specific, English teachers should be aware of the great values of digital technology in China's development and education innovation, as well as the impacts and challenges brought about by the rapid development of digital technology. What's more, English teachers should be willing to actively learn and use digital resources, take the initiative to explore and innovate educational digital practice. Finally, they should be confident and determined to overcome difficulties and challenges in digital education and teaching.

### **3.2 Digital knowledge and skills**

Digital knowledge and skills lay a solid foundation for the deep integration of digital technology and education and teaching. Digital knowledge mainly requires English teachers to understand some common concepts and basic principles related to digital technology. On the



one hand, digital skills require English teachers to master the principles and methods of selecting digital resources such as digital equipment, software and platform in teaching. On the other hand, teachers should be familiar with the use of digital equipment, software and platforms commonly used in education and teaching and be able to solve basic technical problems.

### 3.3 Digital application

Digital application reflects the comprehensive competence, which is the core content of teachers' digital literacy. It is involved in digital teaching design, implementation, assessment and digital collaborative education.

Digital teaching design requires English teachers to use digital technology resources to analyze students' learning and effectively acquire and manage digital educational resources. In addition, English teachers should be able to design digital teaching activities according to teaching objectives.

The implementation of digital teaching requires English teachers to conduct teaching activities, regulate and optimize the teaching process, and support individualized teaching with the help of digital resources.

Digital assessment requires English teachers to select and use the assessment and collection tools reasonably, adopt appropriate data analysis models, and present and interpret academic data analysis results with the help of digital tools.

Digital collaborative education requires English teachers to pay attention to the cultivation of students' digital literacy, conduct moral education and mental health education, and achieve more effective collaborative education.

### 3.4 Digital social responsibility

Professional development is the basic moral quality requirement for teachers in the digital society as well as a necessary prerequisite for the sustainable development of digital education. It includes law and moral based norms and digital security. Teachers should consciously regulate their own online behavior and jointly maintain a positive and healthy network environment.

### 3.5 Professional development

Professional development refers to the ability to use digital technologies and resources to promote individual sustainable development and collective growth, including digital learning and research, digital teaching research and innovation.

## 4. Conclusion

According to the above analysis, college English teachers can have an explicit understanding of digital literacy, and it is urgently needed to cultivate their digital literacy so as to promote China's international communication power and influence in the world.

## References

- [1] GILSTER P. Digital literacy[M]. New York: Wiley Computer Publications, 1997.
- [2] HAGUE C, PAYTON S. Digital literacy across the curriculum[EB/OL]. (2010-01-01) [2023-06-01].  
<https://www.nfer.ac.uk/digital-literacy-across-the-curriculum/>
- [3] Jones, R. Digital literacies[A]. In Hinkle, E. (ed.). Handbook of Research into Second Language Teaching and Learning [C]. London: Routledge, 2016.
- [5] Jurida, S. H. et al. Netspeak: Linguistic properties and aspects of online communication in postponed time [J]. Journal of Foreign Language Teaching and Applied Linguistics, 2016(3).
- [6] Yang Zongkai. Use the "digital base" of high-quality education support system[J]. China Education News, 2021(8)31-34.

# The Ideological and Political Construction of Financial Management Courses Based on the FT Course Construction Model

Jun Yin

Hainan Vocational University of Science and Technology Haikou, Haikou 571126, China.

---

**Abstract:** In today's society, the development of the financial industry is becoming increasingly rapid, and education in the field of financial management is also receiving increasing attention. However, with the continuous changes in the financial market, the education of financial management majors also needs to be constantly updated and improved. At the same time, with the increasing demand of society for talent quality, the importance of ideological and political education in professional education has also become increasingly prominent. In recent years, the new FT curriculum construction model has entered the public's perspective, not only as an educational concept, but also as an educational and learning method. Therefore, this article explores the ideological and political construction of financial management courses based on the FT course construction model.

**Keywords:** Financial management; Curriculum ideological and political education; FT course construction mode

---

## Preface

The core value of FT courses lies in cultivating students' innovative spirit and practical abilities, allowing them to gain a comprehensive experience of knowledge, skills, and emotions during the learning process, thereby improving their overall quality. As an important component of talent cultivation in universities, ideological and political education also plays a crucial role in the cultivation of financial management professionals. Therefore, integrating ideological and political elements into the teaching system of the financial management major, combined with the educational concept of FT course construction, to construct a new ideological and political education system for the financial management major is an important topic for talent cultivation in the financial field.

## 1. Overview of FT Course Construction Model

### 1.1 Concepts

The FT curriculum construction model, namely the Four Principles and Three Methods curriculum construction model, is an educational and teaching model centered on ability cultivation. This concept originates from the relevant requirements proposed by six ministries, including the Ministry of Education, to carry out teaching activities in accordance with the requirements of real environment, real learning, real practice, and mastering real skills. And introducing theories such as systematization of work processes and practical application based curriculum construction proposed by industry scholars, combined with China's requirements for the integration of industry and education and the dual education of schools and enterprises in higher education, the development methods of application based curriculum are finally summarized: work task curriculum, teaching task workflow, and work process systematization <sup>[1]</sup>.

In the FT course construction model, we should adhere to the premise of teaching activities based on a real environment, and use real learning and practice as an important means of mastering true skills. By transforming work tasks into courses and teaching tasks into work, we deepen the integration of industry and education, and comprehensively cultivate students' practical abilities and comprehensive qualities.

### 1.2 Key points

Integrating course content with professional standards: Combining course content with professional standards, developing course content based on professional ability and quality requirements, so that students can better adapt to future career development needs. This requires a deep understanding of industry standards and professional requirements, to achieve a close connection between course content and professional standards <sup>[2]</sup>.

Integrating teaching methods with production processes: Combining teaching methods with production processes, carrying out teach-

ing work based on the concept of “three truths”, enabling students to better grasp practical production skills and operating methods. This requires strengthening cooperation between schools and enterprises, building high-level training bases, and allowing students to feel the real work scene and atmosphere.

Matching Teacher’s Role with Dual Teacher Quality: Integrating Teacher’s Role with Dual Teacher Quality, enabling teachers to have both theoretical and practical experience. This requires strengthening the cultivation and training of teachers, improving their professional literacy and teaching ability, and encouraging them to participate in practical work and accumulate practical experience.

Matching evaluation methods with industry standards: Combining evaluation methods with industry standards and using industry standards for student final evaluation, making the evaluation results more objective, fair, and practical. This requires establishing a sound evaluation mechanism and standards to truly reflect students’ abilities and levels.

## **2. The importance of strengthening ideological and political education in cultivating financial management professionals**

### **2.1 Improving students’ comprehensive quality and innovative ability**

Ideological and political education not only includes ideological and moral education, but also covers multiple aspects such as politics, psychology, and humanities. By strengthening ideological and political education, students’ comprehensive qualities such as political, psychological, and humanistic qualities can be improved. Guide students to combine professional knowledge and focus on industry development, engage in deep thinking and exploration, cultivate their innovative awareness and ability, and enable them to have the ability to think independently and solve problems, providing more possibilities for future career development.

### **2.2 Helping students adapt to the development trends of economic globalization and financial innovation**

With the continuous development of economic globalization and financial innovation, the competition in the financial industry is becoming increasingly fierce. By strengthening ideological and political education, financial management majors can help them adapt to future development trends, improve their international perspective and cross-cultural communication abilities, and thus have the ability to adapt to future financial market changes and risk management. Expand the career development space of contemporary college students, improve their employment competitiveness, and cultivate composite talents with innovative spirit and practical ability.

### **2.3 Enhance students’ sense of social responsibility and public awareness**

The financial industry is an industry that requires a high level of social responsibility and public awareness. By strengthening ideological and political education, students majoring in financial management can enhance their sense of social responsibility and public awareness, making them aware of the impact of their professional behavior on society and the public, and thus better fulfill their social responsibilities and obligations. At the same time, ideological and political education can also enable young people to master the ability to participate in public affairs and solve social problems, making more contributions to future social development and the public image of the financial industry.

### **2.4 Help students establish correct values and professional ethics**

Financial management professionals are the backbone of the future financial industry, and their thoughts and behaviors are directly related to the stability and development of the financial industry. Therefore, it is necessary to cultivate a group of high-quality financial management talents to ensure the healthy development of the national economy. By strengthening ideological and political education in higher education, financial management professionals can establish correct values and professional ethics, enabling them to possess basic professional qualities such as integrity, law-abiding, fairness, and responsibility, laying a solid ideological foundation for their future career.

### **3. Constructing a New Course Ideological and Political Model for Financial Management Majors Based on the Concept of FT Course Construction**

#### **3.1 Deepen the integration of industry and education, and achieve real learning and action in a real environment**

Financial management majors should actively promote the integration of industry and education, cooperate deeply with enterprises, and jointly create a real ideological and political environment for courses. By introducing real business cases and practical operations, students can experience the actual working environment of the financial industry, understand professional ethics and industry norms, and better grasp practical skills and operating methods. At the same time, it can also guide students to timely understand the development trends and market demands of the financial industry, adjust and optimize course offerings, and improve the quality of talent cultivation.

#### **3.2 Systematically design teaching content guided by work tasks**

The ideological and political education of financial management courses should be guided by work tasks and systematically designed with teaching content. By analyzing and summarizing the work tasks in the financial industry, the actual work content is transformed into teaching tasks, enabling students to master relevant knowledge and skills in the process of completing work tasks. Meanwhile, through systematic design, ideological and political education can be integrated into the entire teaching content, achieving a subtle and silent educational effect.

#### **3.3 Diversified teaching methods to enhance students' learning experience**

The ideological and political education in financial management courses should adopt diversified teaching methods to enhance students' learning experience. For example, by analyzing real financial cases, students can understand the importance of professional ethics and laws and regulations; Developing students' teamwork and communication skills through group collaboration and communication; And by simulating real work scenarios, students can better understand and master practical operational skills.

### **4. Summary**

Based on the concept of "Three Truths and Four Modernizations" FT course construction, this article proposes a series of strategies to construct a new curriculum ideological and political education model that meets the requirements of financial management professional talent cultivation mode and the new era of ideological and political education in universities. By deepening the integration of industry and education, leading work tasks, and introducing diversified teaching methods, we aim to enhance students' learning experience, and pay attention to the comprehensive optimization of the teaching team, teaching evaluation mechanism, and campus cultural atmosphere. The implementation of these measures can better cultivate high-quality financial management talents and make greater contributions to the development of China's financial industry.

### **References**

[1] Bi Shiqi, Li Yang, Yao Yao Research on the Construction of Excellent Open Courses in Higher Education Institutions under the Background of "Curriculum Ideology and Politics" - Taking the Course of "Finance" as an Example [J]. Business Economics, 2023 (6): 181-183.

[2] Yu Hongjie, Jia Yinan The Application of the "Four Truths and Three Modernizations" Course Construction Model in the Teaching of College Physics Experiments [J]. Journal of Chifeng University: Natural Science Edition, 2023, 39 (7): 88-90.

Author Introduction: JunYin , May 1977, female, Liuyang, Hunan, pursuing a master's degree, Hainan Vocational University of Science and Technology, intermediate economist, international finance.

Project approval: Ideological and political construction of financial management major based on FT course construction mode HKJG2022-40

Research on Ideological and political Construction of financial professional courses based on FT mode under the background of Digital Economy, Project No.: 230803230192239

# Exploration of Data Science Construction in Big Data Environment

Tianshu Shi

University of California, Los Angeles 90095

---

**Abstract:** With the development of science and information, building an informatized army in a big data environment and building military data science has become the strategic goal of China's military construction. To realize this goal, it is necessary to obtain the data advantage. As a result, the level of military data science construction has become an important symbol to measure the capacity of military informatization. For this reason, the article puts forward the idea of constructing the basic theoretical framework of military data science from three perspectives in view of the necessity of carrying out the exploration of military data science construction under the big data environment.

**Keywords:** Big data; Military data; Science building

---

Facing the trend of change in information technology, our military construction must make good use of data to speak. Therefore, in this new period, for how to extract data more effectively, a new discipline, namely, data science, has emerged, and its emergence has attracted a certain amount of attention in the academic community as well as other industrial circles.

## 1. The necessity of military data science construction inquiry in the big data environment

### 1.1 Current work needs cannot be met

Under the new era of big environment data, intelligence science and data science have begun to integrate and develop. The previous knowledge structure framework of intelligence science cannot be satisfied for the current military work. To some extent, intelligence and data science still have some common ground, both are the study of information and data, and integrate valuable information. However, intelligence science emphasizes "speaking with data" and data science emphasizes "letting data speak", the former is to make certain adjustments to the disordered data, the latter is to reduce people's empirical methods, use data to dig out the desired answers and relationships, and more objectively Understand the actual situation of things. In the face of the current situation, it is necessary to introduce data science related theories and technologies to promote the overall development of<sup>[1]</sup>.

### 1.2 Data science does not meet the special needs of military data work

Data science is not the same as big data, but it is also a little bit similar. With the research done in recent years, data science has become a separate discipline and has gained popularity. There are more and more books, research organizations, etc. related to data science. Due to the military data work there are certain special needs, so data science can not meet the following aspects: First, the object of research is different, military data is mainly studied, analyzed military data, confrontational, high confidentiality requirements, the need for specific theoretical guidance. Second, the working environment is not the same, military data need to take into account the special scenarios of data processing and application. Third, the theoretical focus is also different, military data also need to focus on practical elements and value elements. Fourth, military data work has its own special needs. Existing algorithms and models, in the absence of application scenarios, the data can not play its own value. Since the scenarios of military activities are different from those of general scenarios, military data work should be carried out under the guidance of relevant theories.

## 2. Exploring the construction of military data science with "three perspectives" in the big data environment

The so-called "three perspectives" are elements, processes, and values. Data science in which the relevant works are mainly to describe the technology and methodology, rarely from the theoretical structure. To build military data science, the core task is to integrate the current

military data work in China, but also military data theory and methodology research and construction, so as to establish a theoretical framework to improve the scientific and efficient military data work<sup>[2]</sup>. For this reason, this article breaks the practice of data science with workflow to discuss, and proposes three perspectives to build the basic theory of military data science, as follows:

### **2.1 Military data science grounded theory from an elemental perspective**

This perspective on conducting military data science grounded theory is discussed in terms of the static components associated with military data science activities. Essentially, military data science is a way of extracting useful data from military big data based on scientific methods, processes, and algorithms. In this process, it is aimed at providing data services to the needy users. And to obtain certain information from the data, there are many points included in this series of activities. The most important of them are demand, resources, technology, standards and products. In other words, grounded theory under the elemental perspective is a description of the above points to form a whole.

Among them, demand plays a guiding role, military data demand is the starting point for constructing the data system, which is the basis for subsequent research. Data also has an irreplaceable role, military data resources are from the perspective of the data to describe the military, determine the military data processing process, elements and other relationships, to provide data to different levels of personnel, build a bridge between the military business and data. Technology is the core, there is an important role, it is the military data science, the focus of the relevant personnel to explore the issue, mainly is the military data management and application, as well as other technologies combined into a technical whole with many functions. In fact, military data science is the use of relevant technologies to achieve data analysis, modeling, and ultimately realize the full value of the data. Standard is the foundation and guarantee, and for the construction of military informatization and intelligence, the standardization of military data is the fundamental work. In the construction of military data science theory, this is the core and focus as well as the key to realizing the value of data. The final presentation of military data science activities is military data products.

### **2.2 Military data science grounded theory from a process perspective**

This session is an exploration based on the key stages of the military data lifecycle process. The goal of military data science is to study military data, and to use data statistics and machine learning as the theoretical basis, and then carry out data processing, analysis and other activities. It can be considered that military data science not only to design static elements, but also need to use some technology to revitalize military data, from which valuable and meaningful data can be mined. The whole process is the whole life process of military data under the guidance of military data theory<sup>[3]</sup>.

This stage can also be effectively decomposed, and after decomposition are the stages of sensing and acquiring military data, integrating and saving military data, organizing military data, effectively analyzing military data, visualizing military data, and developing military data products. The first stage of perception and acquisition is to solve the problem of the source of data and is the beginning of a series of activities. The second stage mainly addresses the organization and preservation of data. The third stage of organizing is to address the quality of the data. The effective analysis stage is to solve the problem of increasing the value of military data by using appropriate statistical as well as analytical methods, etc., and to work on developing other functions of military data. Military data visualization is mainly used to solve the problem of the final presentation of military data, and it is an important form of presentation<sup>[4]</sup>.

### **2.3 Military data science grounded theory from a value perspective**

This process is mainly discussed from the main application scenarios of military data. In summary, military data science is a science of realizing the value of data. Since every military activity generates a large amount of data in the process, data is also the core resource of the military sector. But in the past situation, data is just a resource and does not create value. But in fact, if the data can bring certain military benefits, it also has value and significance. Therefore, the essence of military data science is to take military data as the basis and object of inquiry, and to devote itself to realizing the value of military data. If the data all-round begins to integrate into the military field, it can become an important strategic resource. Therefore, the basic theory of military data science under the value perspective is to clarify the driving role of

military data in all aspects.

### 3. Conclusion

In conclusion, in the context of the big data era, military data science construction is an important part of China's military informatization construction. Relevant staff need to adjust China's informationization construction based on the latest development of big data technology, strengthen the innovation of data science construction, and commit to promoting the comprehensive development of military data science construction.

### References

- [1] Tang Shanhong, You Hongliang, Gao Qiang, et al. Reflection on Promoting Military Data Science Construction in the Big Data Environment [J]. *Intelligence Theory and Practice*, 2022, 45 (7): 5.
- [2] Tao Wan, Shi Jianguo. Exploration of the Construction of Data Science and Big Data Technology Majors in Ordinary Local Universities - Taking Anhui Engineering University as an Example [J]. *Journal of Huanggang Normal University*, 2018, 38 (6): 4.
- [3] Gao Jie. Exploration of Digital Library Data Resource Construction in the Big Data Environment: A Survey and Analysis Based on the National Science and Technology Digital Library [J]. *China Basic Science*, 2018, 020 (003): 53-57.
- [4] Liu Jingtao, Lin Zhiwen, Liu Chao. Research and Reflection on Military Big Data Construction [J] [2023-12-15].

# Responding to “the Asking of Qian Xuesen “-Survey and Exploration on Cultivation of Outstanding Talents in China

Xiaofang Guo, Rong Liu, Xiao Wang \*

Qingdao City University, Shandong 266106 , China.

---

**Abstract:** “The Asking of Qian Xuesen “ is a problem that the whole education sector has been concerned about and has not been able to answer.” This survey focuses on the cognition and thinking of “ the Asking of Qian Xuesen “ in the context of the “18th National Congress”. We used the method of mutual control random sampling, and according to the questionnaire to organize and analyze the results, and at the same time apply the SPSS software to analyze the factors of perception and recognition, and conduct an in-depth study on the reasons for the emergence of “ the Asking of Qian Xuesen “ and the countermeasures. On this basis, it draws corresponding conclusions and puts forward relevant suggestions.

**Keywords:** The Asking of Qian Xuesen; Innovation; Outstanding talents

---

## 1. Introduction

On March 29, 2005 Qian Xuesen made the last systematic talk in his life: “Today, the Party and the country are attaching great importance to the issue of scientific and technological innovation, but I think it is more important to have talents with innovative ideas. China has not yet a university can be in accordance with the mode of training scientific and technological invention and creation of talents to run the school, there is no unique innovation of their own things, I see, this is China’s current a big problem.” “China always fails to produce outstanding talents. This is a big problem.” “Cultivating outstanding talents is not only a basic principle for education to follow, but also a fundamental for the country’s long-term development.” From July 2005 to August 2009, “why do our schools always fail to produce outstanding talents?” Qian Xuesen repeatedly raised such a deep-rooted question. However, he never got an answer. Countless scholars have discussed and researched this issue, but still could not come up with a unified answer and solution. This is the last words of Qian Xuesen, also widely reported by the media as “ the Asking of Qian Xuesen “.

## 2. Survey program design and sample analysis

A sample of 195 questionnaires was collected from five universities. This research we use the simple random sampling method, the percentage of the total number of male students in this sample of the research object is 54.4%, the percentage of the total number of female students is 45.6%, from the pie chart of the distribution of the male ratio can also be seen, the proportion of male and female distribution is more uniform, basically in line with the actual distribution of male and female ratios, so our sampling this time is a better, representative sample. Among the random sample, 20% were freshmen, 13.3% were sophomores, 23.1% were juniors, 21% were seniors, and 22.6% were graduate students. The sampling of “ the Asking of Qian Xuesen “ survey is relatively even in the proportion of each grade, and the sampling is reasonable.

## 3. Survey and analysis on the awareness of “ the Asking of Qian Xuesen ”

### 3.1 Analysis of the recognition of outstanding talents in the question of “the Asking of Qian Xuesen ”

For college students to “ the Asking of Qian Xuesen “in the cognitive analysis of the type of outstanding talent, we can see that the survey respondents, that outstanding talent is innovative talent accounted for 62.6%, is an academic master accounted for 19.0%, is rich in practical experience accounted for 8.7%, is a successful career accounted for 9.7%.



### **3.2 Analysis of the awareness of the requirements of outstanding talents in the question of “ the Asking of Qian Xuesen” .**

The analysis of college students' awareness of the conditions of outstanding talents in the question of “ the Asking of Qian Xuesen “ can be seen: 80.5% of the respondents believe that one of the conditions of outstanding talents is the sense of doubt and innovation. Innovation has great productivity, and more than 80% of college students think that outstanding talents need to have the sense of doubt and innovation, from which it can be seen that college students regard the condition of doubt and innovation as very important in the process of becoming outstanding talents or recognized outstanding talents. In addition, 65.1% of them think that they need to have the spirit of hard work, while 62.1% of them think that they need to have a reasonable knowledge structure and be able to combine with practice.

## **4. Reflections on how to answer “the Asking of Qian Xuesen ”**

### **4.1 Reflections on the National Answer to the“ the Asking of Qian Xuesen ”**

In terms of the respondents' views on what the state should make efforts in, 79.0% think that promoting the reform of the university system is one of the measures that the state should take, so it is very important to promote the reform of the university system, set up a pilot project for universities and do a good job of monitoring the process and evaluating the effects. 67.2% think that guiding the correct social values is one of the measures that the state needs to take in order to cultivate outstanding talents.

### **4.2 Reflections on the Enterprise's Answer to “ the Asking of Qian Xuesen”**

On the respondents' views on what aspects enterprises should make efforts, 81.5% of them think that enterprises attach importance to innovative talents is one of the measures that can be taken for cultivating outstanding talents, and the concept of employing enterprises will directly affect the mode of cultivating talents in schools, and if a lot of enterprises attach importance to innovative talents, an atmosphere will be formed in the society, which will provide a clearer direction for cultivating talents for schools and teachers, as well as Provide students with useful guidance on the direction of learning and endeavor. 77.9% of them think that enterprises should provide more innovative platforms.

### **4.3 Reflections on the School's Answer to“ the Asking of Qian Xuesen ”**

In terms of the respondents' views on what the school should do, 72.8% of them think that the school should adjust the teaching plan and enrich the after-school activities is one of the measures that the school can take to cultivate outstanding talents, and that the school should adjust the teaching plan, enrich the useful after-school activities, be based on the practice, and provide the useful guidance for the development of the students' innovative thinking. 58.5% of the respondents think that the school should organize more innovative competitions and activities, and that innovative talents account for a part of outstanding talents.

### **4.4 Reflections on Teachers' Answers to Chancellor's Questions**

20.6% of the students think that teachers should cultivate students' teamwork spirit, 18.2% think that they should cultivate students' thinking mode, and 18.2% think that cultivating the spirit of contribution is also important. Overall, teamwork spirit, thinking mode and communication skills are more important.

## **5. Answers to“ the Asking of Qian Xuesen ”**

### **5.1 Requirements for States**

The State should create a liberal and free academic atmosphere Qian Xuesen once said about the academic atmosphere in China, “Everyone is polite, academic discussion is not active, how can this cultivate innovative talents.” The loose and free academic atmosphere is conducive to the expression of opinions and mutual exchange of ideas. This also triggers another problem, which is plagiarism in academia. Many people are not able to create good work themselves and thus choose to plagiarize. This also makes many scholars afraid to express their opinions in public for fear of being plagiarized. Therefore, the state should also enact strict laws in this regard to reduce or even eliminate this

kind of thing.

## 5.2 Requirements for business and society

Enterprises are the source of wealth and an important organization in society as a whole, so the measures taken by enterprises play an extremely important role in solving problems. First of all, enterprises need to pay attention to innovative talents, to understand the importance of innovative talents, secondly, when applying for jobs in enterprises, they should pay attention to innovative talents, increase the publicity of innovation, and create an innovative atmosphere in enterprises as well as in schools, so as to influence the whole society. Finally, enterprises should provide innovative platforms and opportunities for college students to carry out innovative research.

## 5.3 Requirements for schools

Schools are places where students are trained, and the kind of teaching methods practiced in a school often affects the quality of students in that school. First of all, schools should reform the teacher appraisal and selection system, select outstanding teachers and strengthen the teaching force. Teachers should not only be well educated, but also have scientific teaching methods to break the traditional indoctrination. Secondly, the school should enrich the after-school activities of students, and carry out more innovation competitions and other activities, so that students can cultivate innovation consciousness and enhance innovation ability in practice. In addition, it is also necessary to set up a special innovation fund, not only to reflect the importance of the school by the innovative talents, but also to provide better conditions for students to innovate.

## 5.4 Requirements for teachers

Qian Xuesen once said, “Nowadays, students have no interest in knowledge, to what extent the teacher educates and the students learn, such education does not work, the textbook is not the main thing, the main thing is the teacher.” Through the survey, students are very urgent for teachers to change their teaching methods. Teaching according to the student’s ability, individualized teaching, cultivate students’ thinking ability, fast learning ability, communication ability, teamwork ability and contribution ability, teachers are not simply to instill knowledge, but to guide the students to learn how to think, that is, “teaching a fish is not as good as teaching a fisherman”, instilling will only make the students gradually lose the ability to think independently, while the guidance can make the students think more. Indoctrination will only make students gradually lose the ability to think independently, while guiding can make students think more updated knowledge. Teachers not only know students in learning, but also teach students how to behave. Nowadays, university teachers simply teach knowledge, after the class will leave, but the real teacher, not only to preach and teach, but also to teach students what is “virtue”.

How China’s education will develop in the future, and how “ the Asking of Qian Xuesen “can be satisfactorily concluded, still need our common efforts. We firmly believe that under the guidance of the spirit of the 18th National Congress, we will be able to deliver a satisfactory answer.

## References

- [1] Lu Xiaodong “Emergence” and Top Innovative Talents “Emergence”: Answering Qian Xuesen’s Question Again [J]. Beijing Education (Higher Education), 2023, (10): 18-22.
- [2] Zhou Gang, Tang Jun, Wang Haosen. From Qian Xuesen’s perspective on the cultivation of outstanding scientific and technological innovation talents [J]. Journal of Higher Education Research, 2023,46 (03): 11-18.
- [3] Huang Yanqiu “Qian Xuesen’s Question” and Kuhn’s Scientific Development Model [J]. Western Journal of Science, 2023, (01): 146-149.
- [4] Liu Ji’an, Xu Yanru The National Answer to “Qian Xuesen’s Question”: A Review of Policies and Practices for Talent Cultivation in Basic Disciplines [J]. China Talent, 2022, (07): 9-11.
- [5] Yang Xiangdong, Huang Jing, Chen Xi, et al. On Conceptual Understanding and the Educational Cracking Path of “Qian Xuesen’s Question” [J]. Research on Educational Development, 2022, 42 (20): 54-68.

# Research on the Path of Cultivating Self-education Ability of College Students in the Perspective of Internet

Xuan Weng

Anhui Normal University, Wuhu 241002, China.

---

**Abstract:** At present, the cultivation of college students' self-education ability is faced with the problems of inappropriate education methods in colleges and universities, the gap between students' ideals and realities is too big, and the conflict between the internal and external drives of self-education. To achieve the development of college students' self-education ability, colleges and universities have to innovate the cultivation methods, gather the three-dimensional synergies in and out of the classroom, and reasonably make use of the powerful role of rules and regulations, so that the cultivation of college students' self-education ability will be effectively assisted.

**Keywords:** Self-media; College Students; Self-education; Cultivation Paths

---

The former Soviet educator Sukhomlinsky attached great importance to the role of self-education and put forward the famous assertion that "education that promotes self-education is real education", and he believed that self-education plays a dominant role in the education of individuals <sup>[1]</sup>. Teachers in colleges and universities should strengthen the cultivation of self-education ability of college students as an important task of ideological and political education, especially in the stage of rapid development of the Internet, the Internet field is one of the main active places for modern young college students, and it is also an important carrier for ideological and political education of students in colleges and universities, the network is mixed up with mixed and mixed information, and it is a great idea to strengthen the ideological and political education in the field of the Internet to promote the cultivation of the self-education ability of college students.

## 1. Defining the self-education capacity of university students in the Internet domain

The definition of the self-education ability of college students in the field of Internet can be developed from four levels: definition, content, structure and extension.

### 1.1 Definition of self-education capacity of university students

Since ancient times, people have always attached importance to the cultivation of self-education skills. In the traditional thinking and classical writings of Confucianism in China, there are many references to self-education. The Analects of Confucius - Yan Yuan" said: "introspection is not guilty, the husband what worry and what fear?" Zhu Xi even has a note that "to do their own is called loyalty, to the real is called faith. Transmission, so that received from the teacher, learning, so that familiar with their own. The sincerity of his self-governance is such that he can be said to have obtained the foundation of learning." Modern scholars Qiu Weiguang and Zhang Yaocan proposed: self-education method, refers to the educated person according to the goals and requirements of ideological and political education, on the basis of self-awareness, self-knowledge, self-experience, self-control to produce a positive and enterprising heart, and take the initiative to accept the advanced ideas and correct behavior method. <sup>[2]</sup>Synthesizing the research overview and research results of scholars' self-education ability, the author concludes that self-education ability is the ability of an individual to cultivate self-knowledge, self-experience, self-supervision, and self-control based on self-awareness and according to the requirements of social behavioral norms and his or her own expectations, in order to realize the comprehensive development of the individual.

### 1.2 Content of self-education capacity of university students

Self-education ability covers the individual's value judgment and value choice in the four levels of knowledge, emotion, intention and behavior, including self-knowledge ability, self-experience ability, self-monitoring ability and self-control ability. Self-cognitive ability is the ability to make correct judgments about one's own psychology and behavior, including self-observation ability and self-evaluation ability. Self-observation ability focuses on the ability to perceive thinking and perception; self-evaluation ability refers to the ability to make

an objective evaluation of one's own thoughts and behaviors. Self-experience ability focuses on the emotion generated when making value judgment on one's own thoughts, speech, and behavior, i.e., the unified relationship between the needs of the master self and the reality of the object self. Self-monitoring ability refers to an individual's ability to adjust his/her own psychology and behavior on the basis of self-awareness, so as to make it conform to the requirements of the overall moral norms of the society and realize his/her own moral goals. Self-control refers to an individual's ability to control his or her own emotions, desires, and behaviors.

### **1.3 Extension of self-education ability of university students in the Internet field**

The Internet is one of the main active places for contemporary college student groups, and the information on the Internet is mixed, so the self-education ability of college students in the Internet field is more important. First of all, in the era of the Internet, facing all kinds of information, college students should set up correct Internet values, make correct Internet self-knowledge, and treat the development and application of the Internet with appropriate attitudes. Secondly, because of the convenience and independence of the Internet, when facing all kinds of temptations on the Internet, college students have to stick to their hearts, strengthen the norms of their Internet use, and supervise their words and deeds on the Internet. Finally, the network over-entertainment will make students aggravate the growth of negative emotions, which will seriously lead to the loss of control of speech and behavior and loss of learning motivation. Network has the characteristics of diversity, virtuality, complexity, etc. The cultivation of self-education ability for college students in the complicated network environment is one of the main tasks of ideological and political education in colleges and universities in the era of self-media. College students should pay attention to the individual's conscious behavior in the face of all kinds of information in the self-media, strengthen the cognition of self, analyze the information, and make value choices in line with their own development expectations and comply with the social moral norms.

## **2.Second, the real dilemma of cultivating college students' self-education ability in the Internet**

Under the Internet perspective, the cultivation of college students' self-education ability faces many realistic dilemmas, and this paper discusses three aspects, namely, educational pathways in colleges and universities, ideals and realities of the cultivation of self-education ability, and internal and external driving forces of self-education ability.

### **2.1A single educational pathway in higher education**

Many colleges and universities stick to the old ways, still with the traditional "indoctrination" education, the use of "water irrigation" education methods, in the education process only focus on the transmission of knowledge, but ignored the student's understanding and absorption of knowledge, this kind of method is very easy to rigid college students thinking mode or cause college students to reverse psychology, is not conducive to the development of self-education ability of college students. In the Internet era, college teachers with the help of network tools are limited to the classroom with the help of PPT teaching, video viewing, students comprehensive test scoring system, in the teaching process to give full play to the teacher's "preaching and teaching" role, but there are also shortcomings, one is not fully play the function of the network. The rapid development of network technology, the help of teaching is by no means limited to the teacher-led, colleges and universities to make full use of the convenience of the network can promote the cultivation of students' self-education ability, the full realization of the teaching process of the student's own subjectivity, teaching students such as the use of network technology for self-study, self-education. Secondly, students' self-education ability is closely related to the creation of learning atmosphere in colleges and universities. In college, many students are prone to excessive freedom, network entertainment, on this basis, the completion of the basic academic situation is not satisfactory, the cultivation and enhancement of self-education is even more difficult to achieve.

### **2.2 Disconnect between ideals and reality**

Often in theory, they can methodically plan their life and study in advance, but in the reality of concrete implementation, due to the realization of the goal has a certain degree of difficulty, and need to persist for a long time, students will use a variety of excuses to delay and give up their original plan, or even finally end up with no action, due to the continuity of the goal is too long to achieve the internal motivation of the discontinuity is one of the important reasons for the difficulty in improving the ability of college students to self-education.

Secondly, the pressure of “involution” affects the self-improvement of college students. The material satisfaction can not relieve the mental pressure, when the academic upgrading, mortgage, car loans, marriage, social and other real pressures come one after another, those basic material security has not become some college students to rise to the challenge, the bottom of the kettle into a boat, but instead of becoming a hotbed of withdrawal and abandonment of efforts. In the social reality under the pressure of the idea of getting something for nothing than the so-called “bitter over” of the previous generation is more likely to arise, not willing to spend time and energy to improve themselves, in front of the reality of the choice to “lie flat”, muddle through the day. Finally, when college students set goals at the beginning, they did not properly assess their own needs, fully recognize their own status quo, and did not correctly predict the difficulty of achieving the goals, and did not make comprehensive and adequate psychological preparation, resulting in a high level of ambition, in the process of realizing their ideals and the reality of the serious disconnect between the plan, naturally, unable to achieve their expected expectations.

### **2.3 Imbalance in the role of “internal and external forces”**

The cultivation of college students’ self-education ability cannot be separated from their own internal force, but the external force of rules and regulations also has a certain influence on the cultivation of college students’ self-education ability. In the face of the attraction of the network, addicted college students step by step reduce their own requirements for the future, until they give up their own ideals and pursuits, coupled with many colleges and universities on the use of college students in the network norms are not mandatory requirements, which makes it easy for college students to relax their vigilance in the use of the Internet in the campus, give up on their own, and can not be realized in the college students, “master me” and “guest me”. It is also impossible to realize the unity of the “main self” and “guest self” of college students. Furthermore, the rules and regulations formulated by colleges and universities in the field of Internet to enhance the cultivation of college students’ self-education ability are far away from the cultivation mode that students need and expect. In the process of self-improvement, college students are in the contradiction of difficult choices for a long time, which has a negative impact on the cultivation of their self-education ability.

## **3.Exploring the Path of Cultivating Self-education Ability of College Students in the Internet Environment**

Colleges and universities can explore the cultivation of self-education ability of college students in the Internet from three aspects: innovating the educational methods, constructing a new teaching mode, and exerting the auxiliary role of external forces.

### **3.1 Innovative methods of ideological and political education in colleges and universities**

The new generation of young people pursue individuality and liberation, especially with the popularization of the Internet, students are exposed to more and more information and knowledge, extensive knowledge and rapid updating, if colleges and universities can not keep up with the pace of the students in a timely manner, due to the old-fashioned, inevitably can not penetrate into the students’ internal, to understand the inner value of the student’s aspirations, the ideological and political education of the students will not be able to achieve the expected results. Colleges and universities can build a network teaching platform with affinity for teaching content, networked “grounded” training for teachers, so that the teaching classroom is full of fun, attracting students’ attention. regularly organizing teachers to learn network information of interest to students, allowing teachers to integrate into students, understand students’ interests and changes in ideological dynamics, take the initiative to break down identity barriers between teachers and students, update teachers’ teaching content in a timely manner, adapt to the actual life of the students, enhance the subjectivity of students in the learning process, and effectively improve the self-education ability of students.

### **3.2 Fostering self-education skills among university students in three dimensions**

Ideological and political education in colleges and universities should be problem-oriented when formulating teaching objectives, strengthen the research on the laws of the characteristics of the offline ideological and political education and the network ideological and political education respectively, and cultivate college students’ ability to analyze and solve problems in practice, and internalize the theoretical

knowledge into the students' ideological and emotional identity. We should internalize the theoretical knowledge into students' ideological and emotional identity, and strengthen the application of theories in practice. At this stage, the lectures in colleges and universities are still based on theoretical knowledge teaching in the classroom, and the traditional indoctrination teaching is not conducive to the play of the students' practical subjectivity, which can be combined with the advantage of comprehensive and rapid dissemination of information in the field of the Internet, and adjust the traditional teaching mode into the three-dimensional classroom mode of "in-class+out-of-class+online", taking one semester as an example. Take one semester as an example, the first half of the semester, the theoretical knowledge is finished, the second half of the semester. The final evaluation of the results is based on the completion of the three levels of "in-class + out-of-class + online" as the criterion for the end of the comprehensive examination, to play the role of theoretical learning as a guide for practice, to fill in the gaps in the theoretical learning with the help of practice, to use online learning to enable students to have a more comprehensive self-learning of the integrated theory and practice, so that they can form the correct self-cognition in the learning and exercise the excellent skills of self-education in the practice, to strengthen the self-supervision and self-control, to make the correct self-selection, and to form the correct self-cognition.

### 3.3 Utilizing the "external" leading role of rules and regulations

Self-education ability is the internal force of the individual student, life exists in social relations, has a social nature, and cannot be separated from the normative constraints of the external force. The self-education ability of college students is the combination of "self-discipline" and "other discipline".<sup>[3]</sup> Colleges and universities can improve the network operation and use mechanism, formulate a reasonable and complete network behavior reward and punishment system, use the "external force" of rules and regulations to cultivate college students in the network information age network use standard behavior and self-education ability in cyberspace, clarify self-cognition, stabilize self-emotions, and develop the habit of self-supervision and self-control, so as to achieve the goal of self-cognition and self-education.

In addition, the university should pay more attention to the students' self-education ability in the network information age, and cultivate their self-knowledge, stabilize their self-emotions, develop the habit of self-supervision and self-control, and realize the unity of the "master self" and "guest self" in practice, and help them to realize the enhancement of their own ability by means of the guidance-based system, so as to lay a solid self-education foundation for the college students to go out of the campus and face the society. In the age of information chaos, cultivating the self-education ability of college students and fostering the positive driving force of college students to pursue progress is not only an important way for individuals to cultivate lifelong learning ability, promote their own all-round development, and form a sound personality, but also an important guarantee to standardize the social governance system, safeguard the stability and harmony of the society, and promote the healthy development of the country.

## References

- [1] Sukhomlinsky. Advice to Teachers, the next book [M]. Beijing: Educational Science Publishing House, 1981.
- [2] Qiu Weiguang and Zhang Yaocan, eds. Principles of Ideological and Political Education, [M]. Higher Education Press, 1999.
- [3] Zhang Jingbo. Slightly discussing the cultivation of college students' self-education ability under network environment [J]. Research on Ideological and Political Education, 2017(12).

Author's introduction: Xuan Weng(1998-), female, Lu'an, Anhui Province, Master's Degree of 2021, School of Marxism, Anhui Normal University. Research direction: ideological and political education. mailing address (Huazin Campus, Anhui Normal University, Jiuhua South Road, Yijiang District, Wuhu City, Anhui Province).

# Research on Preventing College Students from Overusing Network Technology for Learning under the Background of Technological Criticism Philosophy

Yingying Wu, Yibo Song

Zhengzhou Urban Construction Vocational College, Zhengzhou 450000, China.

---

**Abstract:** With the rapid development of network technology, college students are increasingly dependent on network technology in their learning process. However, excessive dependence on network technology learning may bring some negative impacts, such as decreased learning effectiveness and thinking, etc. This article explores the reasons and harms of college students' excessive dependence on network technology learning from the perspective of critical philosophy of technology, and puts forward corresponding countermeasures and suggestions.

**Keywords:** Critical philosophy of technology; Network technology; College students; Critical learning

---

## 1. Introduction

With the rapid development of information technology, the internet has become an important way for people to acquire knowledge and exchange information. As the backbone of future society, college students' learning and thinking methods are of great significance to the development of individuals and society. However, in reality, many college students overly rely on network technology for learning, which not only affects their learning effectiveness, but may also lead to some potential problems. Therefore, from the perspective of critical philosophical theory of technology, it is of great significance to criticize the excessive reliance of college students on online technology learning.<sup>2</sup> Concept definition.

## 2. Concept definition

### 2.1 Philosophy of Technical Criticism

Critical philosophy of technology is a philosophical trend aimed at critical thinking about technology. It believes that technology is not a neutral tool, but a force with social and political influence. The core idea of critical philosophy of technology is that technology is not just a tool, but a social phenomenon that is closely related to society, culture, politics, economy, and other aspects. The purpose of critical philosophy of technology is to explore the impact of technology on human society and how technology shapes and changes the development of human society<sup>[1]</sup>.

The critical philosophy of technology focuses on issues such as how technology affects people's lifestyles, social relationships, values, and power structures. It emphasizes that the development of technology is not simply a technical issue, but a profound social problem. Representative figures in critical philosophy of technology include Herbert Marcuse, Jacques Erida, Neil Postman, and others. Through critical thinking on technology, they have revealed the profound impact of technology on human society.

### 2.2 Network Technology

Network technology refers to the technology that enables information exchange and sharing through computer networks. It includes computer network technology, internet technology, email, instant messaging, social media, cloud computing, the Internet of Things, and so on. The development of network technology has enabled people to access information and communicate more quickly and conveniently, changing their way of life and work.

The development of network technology has given rise to new business models and ways of social interaction. People can engage in daily life and work through online shopping, online payments, remote work, and other means.<sup>[2]</sup>The rise of social media has also made it

more convenient for people to socialize and share information. At the same time, network technology has also brought new security and privacy issues, requiring continuous strengthening of network security and protection of personal privacy.

### **2.3 Educational Technology**

Educational technology refers to the use of technological means to improve teaching and learning outcomes. It includes computer-aided teaching, online education, online courses, educational games, virtual reality, artificial intelligence, etc. The development of educational technology has made education more personalized, flexible, and efficient.

The development of educational technology has made learning no longer limited by time and space. Students can learn courses online, engage in online discussions, and do homework. Teachers can use educational technology to design more vivid and interesting teaching content, improving students' learning enthusiasm and participation. Meanwhile, educational technology has also brought new challenges, such as how to protect student privacy and ensure the quality of online education. Educational technology needs to be combined with educational theory in order to better serve the development of education<sup>[3]</sup>.

A Review of Network Technology, Educational Technology, and Software Learning Applications for College Students: Current Status and Trends With the rapid development of information technology, network technology, educational technology, and various learning software have become an indispensable part of the learning life of contemporary college students. The widespread application of these technologies not only changes traditional learning methods, but also provides more abundant and convenient learning resources for college students. However, just like the duality of any technological development, these technologies bring convenience but also have some negative impacts. This article aims to summarize the current situation and trends of college students using network technology, educational technology, and software for learning, and explore their negative impacts<sup>[4]</sup>.

## **3. The current situation and trend of using network technology for learning**

### **3.1 Widespread Application of Network Technology**

Nowadays, network technology has penetrated into various aspects of college students' learning. Whether through online courses for remote learning or using search engines to search and integrate academic materials, network technology has provided unprecedented learning convenience for college students. Meanwhile, social media and online forums also provide a platform for college students to exchange academic ideas and share learning experiences.

### **3.2 Continuous Innovation in Educational Technology**

Educational technology, as an important bridge connecting teaching and learning, is also constantly developing and innovating. For example, the application of multimedia technology makes teaching content more vivid and interesting; Online evaluation and feedback systems can help students timely understand their learning progress and effectiveness, thereby adjusting their learning strategies.

### **3.3 The Rise of Software Learning**

With the emergence of various learning software, software learning has become an emerging way of learning. These software not only provide rich learning resources, but also customize teaching according to the personalized needs of students. For example, language learning software helps students improve their language application abilities by simulating real language environments; Programming learning software provides practical projects to help students master programming skills through practice.

### **3.4 Negative impacts of excessive reliance on network technology learning**

With the increasing dependence of college students on network technology, educational technology, and software learning, some students may experience an excessive dependence on technology. This may make it difficult for them to learn effectively without technical support. In addition, excessive reliance on technology may also lead to students lacking the ability to think independently and solve problems. Network technology makes information acquisition exceptionally convenient, but at the same time, it may also lead to the problem of infor-



mation overload. College students may feel at a loss when facing massive amounts of information, making it difficult to filter out truly valuable information. In the long run, this may affect their learning efficiency and quality.<sup>[5]</sup> Although network technology provides convenient social platforms for college students, excessive addiction to virtual socializing may lead to a decline in their social skills in real life. In addition, some students who excessively expose their personal privacy online may also have adverse effects on their physical and mental health. Long term use of electronic devices such as computers and mobile phones may lead to some health problems, such as decreased vision and cervical pain. In addition, excessive use of electronic devices may also affect the sleep quality of college students, thereby affecting their learning outcomes and physical health.

## **4. Discussion on excessive use of network technology by students from the perspective of critical philosophy of technology**

From the perspective of critical philosophy of technology, we need to recognize that the development of network technology is not blindly promoting and following, but requires careful thinking and rational use. We should encourage college students to acquire knowledge in a diversified way in their studies, not only relying on network technology, but also cultivating their reading, thinking, and critical thinking abilities. In addition, schools and families should also strengthen the education of network literacy for college students, guide them to use network technology rationally, and avoid excessive dependence.

### **4.1 The impact of critical philosophy of technology on the large-scale use of teaching software and hardware in the field of education today**

In the field of education, the impact of technology critical philosophy on the large-scale use of teaching software and hardware is mainly reflected in the following aspects:

#### *4.1.1 Redefining the teacher-student relationship*

The philosophy of technological criticism holds that modern technology is redefining the teacher-student relationship. Traditionally, teachers are the transmitters and interpreters of knowledge, while students are the recipients of knowledge. But with the help of teaching software and hardware, students can engage in self-directed learning through search engines, online courses, and other digital resources. This shifts the role of teachers from being knowledge transmitters to being guides and mentors of learning, while students become more proactive knowledge builders.

#### *4.1.2 Changes in knowledge acquisition methods*

The philosophy of technological criticism holds that modern technology has changed the way knowledge is acquired. In traditional education, students mainly acquire knowledge through classroom learning, reading books, and other means. In the digital age, students can acquire knowledge through digital resources such as search engines, online courses, and digital libraries. The transformation of this knowledge acquisition method allows students to arrange their learning time and location more flexibly.

#### *4.1.3 Improvement of educational equity*

The philosophy of technological criticism holds that modern technology helps to improve educational equity. In some impoverished areas, due to limited teaching resources, students often find it difficult to access high-quality educational resources. Digital educational resources can break geographical limitations and enable all students to access high-quality educational resources. This helps to narrow the education gap between urban and rural areas and improve educational equity.

## **5. The Impact of Artificial Intelligence Technology on the Education Sector**

Artificial intelligence technology can provide personalized learning plans for students based on factors such as their learning style, interests, and learning abilities. This helps to improve the learning effectiveness and interest of students. For example, intelligent teaching systems can recommend suitable learning resources and exercise questions for students based on their learning situation. Artificial intelligence technology can automatically evaluate students' learning outcomes and homework quality, and provide timely feedback and suggestions to students. This helps to reduce the evaluation burden on teachers, improve the accuracy and efficiency of evaluations. Meanwhile, students

can also adjust their learning strategies in a timely manner based on feedback to improve learning outcomes. Artificial intelligence technology can provide decision-making support for educational institutions. For example, by analyzing a large amount of educational data, artificial intelligence technology can help schools make more scientific teaching plans, resource allocation, and enrollment policies. This helps to improve the management level and decision-making efficiency of educational institutions.

## **5.1 Criticism of the Overreliance on Technology in the Future Education Sector**

Although modern technology has brought positive impacts to the field of education, if there is a trend of excessive reliance on technology in the future, it may bring some negative impacts. The following is a criticism from the perspective of technology critical philosophy that there may be an excessive reliance on technology in the future education field:

### *5.1.1 Technology replacing human teachers*

With the continuous development of artificial intelligence technology, some people may advocate for the complete replacement of human teachers with intelligent teaching systems. However, from the perspective of critical philosophy of technology, although artificial intelligence technology can assist in teaching and evaluation, it cannot completely replace the role of human teachers in certain aspects. For example, human teachers can provide emotional support, personality charm, and innovative thinking guidance for students, which are difficult to replace with artificial intelligence technology.

### *5.1.2 Privacy and data security issues*

With the increasing dependence on technology in the education sector, issues of student privacy and data security are becoming increasingly prominent. If a student's personal information is leaked or abused, it may cause harm to their personal privacy and rights. Therefore, in the future education field, it is necessary to strengthen the attention and supervision of data management and privacy protection.

### *5.1.3 Expansion of technological gap*

Although modern technology can help improve educational equity, in some cases, it may also widen the technological gap. In some impoverished areas or developing countries, due to the lack of advanced technological equipment and network facilities, students may have difficulty accessing high-quality educational resources. This may lead to further widening of the digital divide, which is not conducive to the balanced development of education.

In summary, the critical philosophy of technology believes that the application of technology in the field of education has both positive aspects and potential negative impacts. In future development, we should maintain a rational and cautious attitude towards the application of technology in the field of education. We should not only fully utilize its advantages to promote the development and fairness of education, but also be vigilant about the risks and problems it may bring.

## **6. How can education managers avoid further imbalances?**

In order to change the trend of high reliance on network technology for learning that may arise in the field of education:

### **6.1 Emphasize the comprehensive development of students**

Although network technology can provide abundant learning resources and methods, it cannot replace the core role of traditional education. Schools should focus on cultivating students' comprehensive qualities, including the development of knowledge, skills, emotions, values, and other aspects. Avoid focusing solely on knowledge transfer and skill development, while neglecting the development of students' emotional and social abilities.

### **6.2 Strengthening the guiding role of teachers**

Teachers play an important role in guiding and assisting students in their learning process. Teachers should improve their information technology literacy and teaching ability, master the ability to screen, integrate, and evaluate network information, and provide students with high-quality learning resources. At the same time, teachers should also focus on cultivating students' independent thinking and problem-solving abilities to avoid excessive reliance on network technology.

### 6.3 Balancing Digital Learning and Traditional Learning

Although digital learning has advantages such as convenience and flexibility, traditional learning also has its irreplaceable value. Students should balance digital learning and traditional learning methods, and choose appropriate learning methods based on their own learning needs and actual situations. At the same time, schools should also reasonably arrange the ratio of digital learning and traditional learning according to the actual situation, ensuring that students can obtain a comprehensive educational experience.

### 6.4 Strengthen the management and supervision of network resources

Schools and parents should strengthen the management and supervision of online resources to ensure that students have access to safe, reliable, and high-quality learning resources. At the same time, the government should also strengthen its supervision of the online environment, combat cybercrime and the spread of harmful information, and provide students with a healthy online environment.<sup>[1]</sup>

### 6.5 Cultivate students' information literacy and critical thinking

Students should improve their information literacy and critical thinking, and use network technology correctly for learning. Students should have the ability to screen, integrate, evaluate, and identify online information to avoid being misled by incorrect information. Meanwhile, students should also focus on cultivating their independent thinking and innovation abilities, avoiding excessive reliance on network technology.

In short, changing the trend of highly relying on network technology for learning requires multiple efforts and cooperation. Schools, teachers, parents, and students should all recognize the double-edged nature of technology and make reasonable use of network technology to bring positive impacts to education, while also being wary of its potential negative impacts.

## 7. Summary

In the field of education, the widespread application of network technology has brought convenience and efficiency, but it has also brought about the problem of excessive dependence on technology. From the perspective of critical philosophy of technology, we should pay attention to the double-edged nature of technology. We should not only utilize its advantages to promote the development of education, but also be vigilant about the risks and problems it may bring. To change the trend of highly relying on network technology for learning, it is recommended that schools, teachers, parents, and students work together. Schools should focus on the comprehensive development of students, strengthen the guiding role of teachers, and balance digital learning and traditional learning. Teachers should improve their information technology literacy and teaching ability, and focus on cultivating students' independent thinking and problem-solving abilities. Parents should strengthen the management and supervision of online resources to provide students with a healthy online environment. Students should improve their information literacy and critical thinking, use network technology correctly for learning, and avoid excessive reliance on network technology. Through various efforts and cooperation, we can achieve the positive impact of network technology on education while avoiding its potential negative impact.

## References

- [1] Chen Xilingzi (2023). Master's Thesis on the Design and Application of Critical Thinking Evaluation Scheme Based on Cloud Class Courses, Tianjin Normal University <https://link.cnki.net/doi/10.27363/d.cnki.gtsfu.2023.000682>doi:10.27363/d.cnki.gtsfu.2023.000682.
- [2] Cheng Bing (2023). The Existence Surface of the Metaverse: Discourse, Technology, and Survival Realm - An Analysis Based on Stiegler's Philosophy of Technology. *Jiangan Forum* (04), 13-18.
- [3] Li Pei and Qiu Hui (2018). Philosophical Reflections on Online Education: Finnberg's Approach to Technical Criticism Theory. *Dialectics of Nature Communication* (05), 111-117. doi: 10.15994/j.1000-0763.2018.05.015.
- [4] Li Pei and Qiu Hui (2018). Philosophical Reflections on Online Education: Finnberg's Approach to Technical Criticism Theory. *Dialectics of Nature Communication* (05), 111-117. doi: 10.15994/j.1000-0763.2018.05.015.
- [5] Alan (2010). Philosophical Critique of Educational Technology (Part 1) - The Problem of Logical Starting Point. *Chinese Educational Technology Equipment* (08), 19-23.

# Integrating popular and electronic music: strategies and practices to stimulate students' interest in modern music education

Chenlei Sun

Conservatory of Music, Yeungnam University, Daegu 38541, Korea.

---

**Abstract:** In the contemporary educational environment, stimulating students' interest has become the key to enhancing teaching effectiveness. Especially in the field of music education, traditional teaching methods often fail to fully mobilise students' enthusiasm. This paper discusses how to refresh the traditional mode of music education by integrating popular music and electronic music to stimulate students' learning interest and improve teaching efficiency. We analyse the current challenges facing music education, especially the shortcomings in interest and ability development, and propose a series of reform measures. These measures include the use of multimedia technology, the creation of a positive learning environment, respect for student agency, and the implementation of positive and timely assessment. Through empirical research, we find that introducing popular and electronic music into the classroom not only enhances students' interest in music learning, but also their creativity and critical thinking skills. Finally, the paper emphasises the key role of teachers in creating and sustaining student interest and the importance of adopting innovative teaching methods in modern music education.

**Keywords:** Music education; Student interest; Popular music; Electronic music; Pedagogical innovations

---

## 1. Introduction

In the field of education, stimulating students' interest in learning has always been one of the core challenges in improving the quality of teaching and learning outcomes. Especially in music education, interest is not only a key source of students' motivation to learn, but also a cornerstone for developing their artistic perception and creativity. However, traditional approaches to music education tend to focus on the teaching of skills and theory, neglecting the importance of interest development and personalised learning. With the advancement of society and the development of technology, traditional music teaching methods are facing increasing challenges, especially in attracting and maintaining students' interest.

In recent years, the popularity of pop and electronic music among the younger generation has provided new perspectives and approaches to music education. These modern forms of music are closely related to students' daily lives and are more likely to resonate with and interest them. Therefore, this paper explores the possibility of integrating popular and electronic music into music education and its effectiveness in stimulating students' interest. We discuss how this integration challenges and changes the traditional model of music education and how it can be used to stimulate students' creative thinking and aesthetic abilities.

The aim of this paper is to explore innovative strategies for introducing popular and electronic music into music teaching, and to analyse how these strategies can help students to better understand and appreciate music, as well as increase their motivation and engagement. Through a review of existing literature and analysis of real-life examples, we will show how this pedagogical approach can contribute to the development of music education and its positive impact on students' attitudes and abilities to learn. Through this study, we hope to provide theoretical and practical support for the reform of modern music education and promote a more inclusive and innovative music learning environment.

## 2. Popular and Electronic Music in Music Education

### 2.1 Characteristics of popular and electronic music and their educational value

Pop and electronic music occupy an important position in contemporary music education because of their wide audience base and rich forms of expression. These music styles are usually closely related to young people's lifestyles and cultural values, and thus are more likely to arouse their interest and resonance. While pop music often has accessible melodies and relatable themes, electronic music demonstrates

new possibilities for musical creativity with its unique sound and technological elements. Both forms of music not only stimulate students' interest in learning, but also promote their awareness and appreciation of musical diversity.

## **2.2 Teaching Strategies for Integrating Popular and Electronic Music**

Effective integration of pop and electronic music into music education requires teachers to have flexible and innovative teaching methods. The following strategies can be used for reference:

**Music selection and student participation:** Select popular and electronic music works that match students' interests, and even let students participate in the selection process. This approach not only increases student engagement, but also encourages them to explore and think more deeply about music.

**Music composition and technology application:** Students are encouraged to create their own musical works using modern technology, such as electronic music composition using music production software. This not only improves their understanding of music technology, but also stimulates creativity.

**Interdisciplinary learning:** Music teaching is integrated with other disciplines such as art, history and language to explore the meaning and impact of popular and electronic music in different cultural and social contexts.

**Cultivation of critical thinking:** By analysing the lyrics and musical elements of popular and electronic music, students are guided to think critically and understand the cultural and social messages behind the music.

## **2.3 Case Study of Teaching Practice**

### **Case 1: Multi-music Composition Project - High School Music Course**

**Background:** The music programme of an urban high school decided to integrate elements of popular and electronic music to stimulate students' creativity and interest.

**Implementation:** The teacher guided the students to research the history and styles of popular and electronic music and encouraged them to create their own musical compositions using music production software. Students were divided into groups and each group chose a musical style to create.

**RESULTS:** Students demonstrated strong engagement and creativity. They not only learnt the technical skills of music production, but also the diversity and cultural values of music through teamwork. In the end, the students presented their work in a concert organised by the school and gained recognition both inside and outside the school.

### **Case 2: Electronic Music Workshop - Extra-curricular Programme for Junior Secondary Schools**

**Background:** A junior secondary school ran an extra-curricular workshop on the theme of electronic music, aiming to attract students interested in modern music production.

**Implementation:** The workshop was led by an experienced electronic music producer who taught students how to create music using electronic devices and software. The programme covered basic music theory, electronic music production techniques, as well as music editing and mixing.

**Results:** The students showed great enthusiasm for electronic music production. They not only improved their technical understanding of music, but also learnt how to express their creativity and emotions. The workshop culminated in a successful music showcase where students were able to present their creations.

## **3. The Effectiveness of Stimulating Students' Interest and Its Long-term Impacts**

### **3.1 Stimulation of students' interest and its effect on learning attitude**

The introduction of popular and electronic music into music education has shown significant effects in stimulating students' interest. This interest not only increases students' enthusiasm for music learning, but also improves their overall attitude and participation in learning.

their overall attitude to learning and engagement. Students have become more actively involved in classroom activities and have shown

initiative in exploring music. This change was not limited to music lessons, but also spread to other subjects, showing a wider positive effect.

### **3.2 Promotion of students' creativity and critical thinking through teaching methods**

By integrating popular and electronic music into music education, teachers provide students with more diverse learning pathways. This diversity includes not only the appreciation and performance of music, but also the creation and analysis of music. Students not only learn about music in the process, but also develop creativity and critical thinking skills. They learn how to analyse musical works, understand their cultural and social contexts, and how to use technical means to create personal works.

### **3.3 Long-term effects and their implications for music education**

The long-term effects of introducing popular and electronic music lie in their ability to continue to stimulate students' interest and contribute to the overall development of music education.

## **4. Conclusion and Future Directions**

### **4.1 Summary of the study**

This study demonstrates the importance and effectiveness of integrating popular and electronic music into music education. This integration not only enhances students' interest in music learning, but also promotes their development in a variety of areas, including creativity, critical thinking and cultural understanding. Through empirical case studies, we have confirmed the feasibility and positive effects of this pedagogical approach in different educational settings.

### **4.2 Suggestions for future music education**

Future music education should continue to explore and integrate various modern music elements and innovate teaching methods to suit students' interests and needs. Educators should continue to focus on the integration of music and technology and the role and significance of music in multiculturalism. In addition, music education should pay more attention to individual student differences and adopt flexible and diverse teaching strategies to meet the learning needs of different students.

### **4.3 Future Research Directions**

Future research should delve into the application of popular and electronic music in music education in different cultures and regions, and how these approaches can adapt to changing educational environments and technological developments. Attention should also be given to the adaptability and effectiveness of this mode of teaching for students with special needs, and how these innovative teaching methods can be replicated in the wider field of education.

## **References**

- [1] Mr Ahmad Risoden. The effect of e-learning (electronic learning) on music theory and music appreciation achievement of Malaysian Grade 1 (Year 7) secondary school students. University of Miami Explorations Papers Press, 2014. 3638475.
- [2] Ren Ceci. Students' learning interest in primary school music education, stimulating and cultivating students' learning interest in primary school music education. *Voice of Yellow River*, 2018 (19).92.
- [3] Qiu Hangzhou. Stimulation and cultivation of students' learning interest in primary school music education [J] *Northern Music*, 2018,38(02); 225.
- [4] Dong Yuping. Exploration of methods to stimulate and cultivate learning interest in primary school music teaching curriculum education research. 2019 (50); 213.
- [5] Zhu Zhixian. *Dictionary of Great Psychology*. Beijing Normal University Press [M], 1989 820.
- [6] Yuan, Liu Pei. The music section of the national standard for arts education in the United States [Z]. 1992.
- [7] Syllabus for the Teaching of Music in Japanese Junior High Schools [Z]. 1989. 1993 Jan.
- [8] High School Music Teaching Daigang, Part I: Objectives [Z] Posted in 1989, 1994,4,1.

# Reflections on Higher Chemistry Education

## ----Study based on the aspartame carcinogenicity controversy

Song Deng, Xiaochun Wu\*

School of Chemistry and Materials Science, Sichuan Normal University, Chengdu 610066, China.

---

**Abstract:** In this paper, we begin with a review of animal and human experiments on the carcinogenicity of aspartame, and then draw out the “seemingly contradictory” conclusions of two internationally renowned organizations, in order to arrive at a unanimous conclusion on the carcinogenicity of aspartame. Secondly, with the analysis of the in vivo reaction of aspartame, we analyze the criteria of the International Agency for Research on Cancer (IARC) for classifying the carcinogenicity grade of substances in order to dispel people’s meaningless fears. Thirdly, based on the discussion of the carcinogenicity of aspartame, we reflect on the current problems in higher chemistry education. Finally, we will give rational advice on how to deal with aspartame in light of the lack of empirical studies.

**Keywords:** Aspartame; carcinogenicity; Carcinogenicity rating scale; Higher chemical education

---

## 1. Introduction

On June 29, 2023, the International Agency for Research on Cancer (IARC) evaluated the potential carcinogenicity of aspartame (identification of carcinogenic hazards), and aspartame is once again in the “spotlight” of food additives. As early as 1981 when aspartame entered the market, the controversy surrounding it is continuous. What is aspartame? Is it really carcinogenic?

Following the International Agency for Research on Cancer (IARC) assessment, the Joint FAO/WHO Expert Committee on Food Additives (JECFA) will update its aspartame risk assessment, including a revision of the Acceptable Daily Intake (ADI) and an assessment of aspartame-related dietary exposures.<sup>[1]</sup> In fact, long before this fiasco, there was a proliferation of papers analyzing the carcinogenicity of aspartame, with heated arguments for and against, for example, aspartame’s adverse effects on blood cells, the brain, the liver, the kidneys, the nervous system, and so on<sup>[2]</sup>. But on the other side, for example, the European Food Safety Authority re-examined critically all existing scientific research on the safety of aspartame in animal and human trials, and the agency’s experts ruled out the potential risk of aspartame causing genetic damage and cancer. The report states that a safe intake dose of aspartame for the general population is no more than 40 mg per kilogram of body weight per day, but that this upper dose limit does not apply to people with phenylketonuria<sup>[3]</sup>. The report states that the safe dose of aspartame for the general population is no more than 40 milligrams per kilogram of body weight per day, but this dose limit does not apply to people with phenylketonuria.

## 2. Discovery of aspartame and its structure

Aspartame is an artificial sweetener that is an amino acid dipeptide derivative. Aspartame entered the market in 1981 when it was officially approved by the FDA for use as a food additive, and like saccharin and sweetener, it is a product of chance. It has been reported that G. D. Searle chemist Jim Schlatter was synthesizing a tetrapeptide, a molecule containing four amino acids, to test drugs for stomach ulcers. Schlatter inadvertently got a small amount of the dipeptide intermediate aspartyl-phenylalanine methyl ester on his hands. Later, he unknowingly licked his fingers before picking up a piece of paper, and a sweet flavor bloomed on his taste buds. At first he thought it was a donut he had eaten before the experiment, but suddenly remembered that he had already washed his hands prior to the experiment. Thus, like Falberg and Sveda, Schlatter traced the sweet flavor back to his lab<sup>[4]</sup>. Aspartame is chemically known as methyl aspartyl phenylalaninate, and after it enters the body, it is broken down in the gastrointestinal tract by esterases and peptidases into phenylalanine, aspartic acid, and methanol<sup>[5]</sup>. It is also known as aspartyl phenylalanine methyl ester. Its structural formula is shown in the figure.

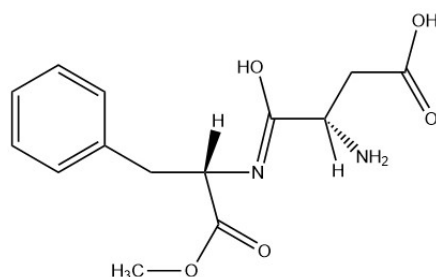

Figure 1 Chemical structure of aspartame

Aspartame is white powdery or needle crystal with hydrolysis degree of 1g/100ml (20°C). It is very stable at room temperature and weak acid environment<sup>[6]</sup>. Sweetness is 200 times that of sucrose; pure sweetness without any aftertaste; low-calorie weight loss; no need for insulin digestion, so it is suitable for obesity, diabetes and cardiovascular patients; anti-microbial, not afraid of mold, no caries; mixed with other sweeteners have a synergistic effect.<sup>[7]</sup> It has a synergistic effect when mixed with other sweeteners.

### 3. Aspartame in vivo reaction

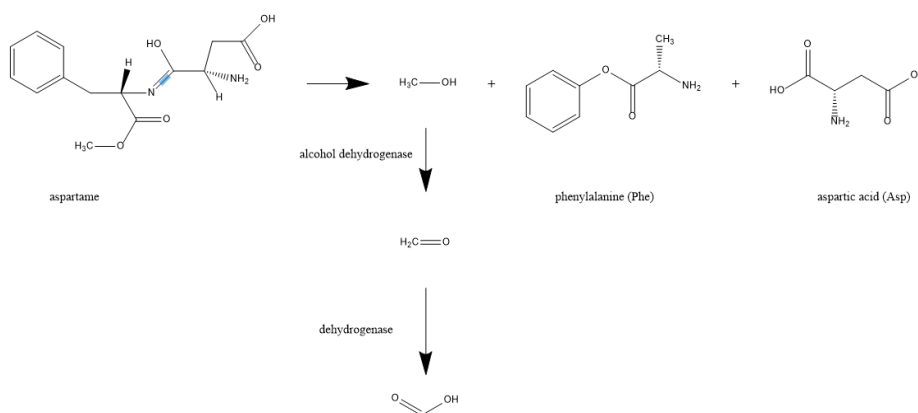

Figure 2 Reactions of aspartame in humans

As can be seen in Figure 2, aspartame undergoes the action of esterases and peptidases to produce substances such as methanol, which in turn reacts with alcohol dehydrogenase to produce formaldehyde, which is a class I carcinogen rated by WHO and the focus of many researchers' controversy over the carcinogenicity of aspartame. In addition to this, phenylalanine, as another in vivo product of aspartame, is also of concern because of its neurotoxicity<sup>[8]</sup>. Through the in vivo reaction of aspartame, we know that its breakdown products, methanol and phenylalanine, are biotoxic - further reaction of methanol produces formaldehyde, which is a class 1 carcinogen; when the concentration of phenylalanine is too high, it is difficult for other amino acids to pass through the blood-brain barrier, which affects neurotransmitter transmission.<sup>[2]</sup> Formaldehyde may seem like strong evidence of aspartame's carcinogenicity, but the truth is that methanol from aspartame is rapidly metabolized to formaldehyde by alcohol dehydrogenase, which then oxidizes the formaldehyde to formic acid in a few minutes, and the formic acid enters the urine and is excreted, or it is further metabolized to carbon dioxide and excreted through respiration.<sup>[5]</sup>

### 4. Controversy over the carcinogenicity of aspartame

Whether aspartame is carcinogenic has been debated since its introduction. Zhang Aike objectively described domestic and international experiments on aspartame's carcinogenicity through the enumeration method, but did not reach a valid conclusion.<sup>[9]</sup> The experimental data are specific to the same experiments. The fact that the experimental data are for the same subjects, but with unrelated results, casts a veil of mystery over the carcinogenicity of aspartame. Let's try to analyze it from the perspective of official documents. There are two "contradictory" official documents about the carcinogenicity of aspartame, one is about the International Agency for Research on Cancer (IARC) classifying aspartame as a Group 2B carcinogen, and the other is about the Joint FAO/WHO Expert Committee on Food Additives (JECFA) Third As-



assessment of Aspartame reaffirming the safety of aspartame in trace amounts, and the other is about the Joint FAO/WHO Expert Committee on Food Additives (JECFA) Third Assessment of Aspartame. safety for consumption. Why did two very specialized international bodies come up with such very different results? In order to answer this question, we may need to first understand the responsibilities of these two bodies.

IARC is an agency of the World Health Organization, with offices in Lyon, France. Its main task is to study the causes of cancer, and it also carries out epidemiological surveys and research on cancer worldwide. However, it is only a purely operational technical organization and is not involved in risk management.<sup>[10]</sup> JECFA, on the other hand, is a Codex Alimentarius international organization. JECFA, on the other hand, is one of the three standing expert committees established by the Codex Alimentarius Commission in 1955, whose members are top experts in the field of food safety evaluation recommended by governments and international organizations, and are responsible for the establishment of quality standards for compounds, methods of analysis, and food safety standards, and the provision of technical advice and recommendations to the Codex Alimentarius Commission. From the point of view of the division of responsibilities of the above organizations, IARC is only a “technical party”, without considering the interests of many parties involved in this substance, while JECFA is to weigh the advantages and disadvantages of many parties before coming to a conclusion, and its assessment results are the main scientific basis for the Codex Committee on Food Additives (CCFA) to develop international food additive standards. Secondly, we also need to understand the criteria of IARC classification, only by clarifying the evaluation criteria can we have a deeper understanding of the meaning of the “labels” put on the substances by the organization. IARC classifies substances in our life into four carcinogenicity classes - Class I, Class II (subdivided into A and B), Class B (subdivided into A and B) and Class B (subdivided into A, B and C). IARC classifies substances in our lives into four classes of carcinogenicity - Class I, Class II (subdivided into two categories, A and B), Class III, and Class IV.

Grade I, can be clearly recognized as carcinogenic to humans. The criteria that can be classified as Grade I are that there is clear experimental confirmation and data verification, the experiment excludes other possible factors that cause cancer, there is a direct relationship between the substance and cancer, there is a response relationship in terms of dosage, and the amount of dosage is more or less than the amount of dosage, and which kind of effect has on inducing cancer. Class IIA, likely to be carcinogenic. There is insufficient evidence of carcinogenicity in humans for these substances, but the evidence of carcinogenicity in experimental animals is conclusive. Class IIB, probably carcinogenic. There is limited evidence of carcinogenicity in humans and insufficient evidence of carcinogenicity in animals in this group. Aspartame belongs to Class IIB. Possible carcinogens in the same class as it include cell phone radiation and pickled vegetables. Class III, carcinogenicity to humans cannot be categorized. Grade IV, probably not carcinogenic to humans. To summarize in layman’s terms, the substances belonging to Grade I will increase the incidence of cancer if they are eaten or contacted, for example, ethanol, as long as you drink any alcohol-containing liquor or beer, it may lead to oral cancer and esophageal cancer. Class II is divided into AB, the difference is that A is a substance with solid evidence of carcinogenicity to animals but limited evidence of carcinogenicity to humans, while B is a substance with limited evidence of carcinogenicity to both animals and humans. In general, as long as IARC classifies a substance as Class II it means that the substance has insufficient evidence of carcinogenicity to humans and may or may not be carcinogenic.

So, in fact, these two organizations are saying the same thing - both state that aspartame is safe to consume if in safe doses. Many substances can be harmful to health if people consume them unchecked, such as white sugar, lobelia, and even drinking plain water can lead to water intoxication. Max’s philosophical principle mentions that one of the causes of material change is that quantitative change leads to qualitative change. Therefore, in our daily life, we do not need to be overly cautious and listen to the wind, but to eat and drink according to the international or domestic safety standards. The value of popularization of science is to dispel the public’s myths and show the way. Therefore, this article suggests: still fear of aspartame crowd can choose to eat other safer natural sweeteners, such as sugar alcohols, glycosides class<sup>[5]</sup> And aspartame difficult to give up the “heavy patients” can also rest assured that there is no sufficient evidence to prove that aspartame must be carcinogenic. For enterprises can also be assured that the production, while saving for a rainy day for innovation - to create a more non-controversial, healthy sweeteners.

## 5. Implications of the aspartame carcinogenicity controversy for higher chemistry education

The aspartame carcinogenicity fiasco reflects not only the problems of basic chemistry education (dosage aside), but also the problems

of higher chemistry education. Higher chemical education refers to the study and training involving the chemical sciences provided in universities or other institutions of higher education, with the aim of assisting students in constructing a comprehensive understanding of the knowledge and principles of chemistry and in developing their scientific and critical thinking skills. However, many people who have received a higher chemistry education continue to unthinkingly boycott aspartame and even all sweeteners in general, lacking the necessary critical and investigative thinking. Higher chemistry education also provides opportunities for collaboration with other disciplines and fields, such as biology, physics, and engineering. It is the cross-application of chemistry and biology that has given birth to synthetic sweeteners that benefit the obese population<sup>[11]</sup>.

## 6. Conclusions

This article then generates significance by combing through the existing literature to draw succinct conclusions, thus helping to understand the current hot scientific issues and giving sound advice. Finally, this article also needs to make a reasonable summary of the mutually exclusive evidence that makes aspartame so complicated and dazzling - IARC and JECFA, the two international authorities on the carcinogenicity of aspartame debate to come to the same conclusion, that is, with regard to the current animal experiments, human experiments, and the study of a number of mechanisms, that are insufficient to prove the direct relationship between aspartame and carcinogenicity. With this clarification, we can treat aspartame more rationally. This article also has some limitations - it consolidates the findings of two major international organizations, but fails to make a clear judgment on whether aspartame is carcinogenic. The limited evidence from both domestic and international studies is not yet conclusive, and more experiments and longer follow-ups are needed to prove the carcinogenicity of aspartame.

## References

- [1] Update on IARC Monograph Session 134 - ACRI [EB/OL]. [2023-07-03]. <https://www.iarc.who.int/fr/news-events/update-on-iarc-monographs-meeting-134/>.
- [2] Xiao, Jinghuan. Health hazards of aspartame in animal testing[J]. *China Food Industry*, 2022(21): 88-92.
- [3] EFSA says aspartame harmless in safe doses[J]. *Food Science and Economy*, 2013, 38(6): 4.
- [4] SAWANT M. Aspartame: History of the Artificial Sweetener[J/OL]. *Berkeley Scientific Journal*, 2011, 14(2)[2023-09-03]. <https://escholarship.org/uc/item/8r30s9hf>. DOI:10.5070/BS3142011713.
- [5] Y. Yan, Y. L., M. Fan. Exploring the sweetness of sugar-free drinks [J/OL]. *Chemistry Education (in Chinese and English)*, 2023, 44(11): 1-8. DOI:10.13884/j.1003-3807hxjy.2022070090.
- [6] Zhou L. Production and application of aspartame[J]. *Food Science*, 1997(7): 18-21.
- [7] Wang JG. Status and development of sweeteners[J/OL]. *Jiangxi Chemical Industry*, 2008(4): 82-84. DOI:10.14127/j.cnki.jiangxi-huagong.2008.04.024.
- [8] SONG Yan, FAN Yongxiang, LI Ning. Progress of safety evaluation of aspartame[J/OL]. *Chinese Journal of Food Hygiene*, 2010, 22(1): 84-87. DOI:10.13590/j.cjfh.2010.01.001.
- [9] Zhang AK, Kan JQ, Chen JW, et al. Progress of safety studies on aspartame[J/OL]. *Food Industry Science and Technology*, 2008(4): 243-244+247. DOI:10.13386/j.issn1002-0306.2008.04.059.
- [10] Li C. Does aspartame cause cancer or not? [N/OL]. *China Science Bulletin*, 2023-07-20: 003. DOI:10.28514/n.cnki.nkx-sb.2023.001710.
- [11] Fu S-H, Li F, Jiang W, et al. Determination of multiple synthetic sweeteners in oral liquid health foods by LC-MS/MS[J/OL]. *Modern Chemical Industry*, 2018, 38(9): 233-236. doi:10.16606/j.cnki.issn0253-4320.2018.09.053.

## About the author:

Wu Xiaochun, Associate Dean, College of Chemistry and Materials Science, Sichuan Normal University, 1995.9-1999.7 Department of Chemistry, Sichuan Normal University (B.S. Chemistry Education), 1999.9-2002.7 College of Pharmacy, Sichuan University (M.S. Pharmaceutical Chemistry), 2004.9-2008.7 College of Pharmacy, Sichuan University (Doctor of Science in Medicinal Chemistry).